



**PRUXX**  
RACING PARTS

**CATALOGUE 2023**

# CONTENTS



## **DIRTBIKE**

Aprilia	10.
Beta	10.
BMW	24.
Gas Gas	26.
Honda	50.
Husaberg	90.
Husqvarna	106.
Kawasaki	154.
KTM	176.
Moto TM	250.
Rieju	256.
Sherco	258.
Suzuki	272.
Yamaha	292.



## **STREETBIKE**

Aprilia	324.
Cagiva	325.
Honda	326.
Kawasaki	330.
KTM	332.
Suzuki	333.
Yamaha	335.



## **ATV-UTV**

Can-Am	344.
Gas Gas	344.
Honda	344.
Kawasaki	364.
KTM	370.
Polaris	372.
Suzuki	384.
Yamaha	392.

## **TECHNICAL**

Tabel of contents	441.
-------------------	------

## **PROMOTIONAL**

Decals, Banners & Speciality items	488.
---------------------------------------	------

## **PROMOTIONAL**

Professional & Promotional apparel	490.
---------------------------------------	------



## **PERSONAL WATERCRAFT**

Hydrospace	412.
Kawasaki	412.
Polaris	414.
Sea Doo	415.
Yamaha	417.



## **SNOWMOBILE**

Arctic Cat	420.
Kawasaki	422.
Lynx	422.
Moto-Ski	423.
Polaris	423.
Ski Doo	425.
Yamaha	430.



## **MOPED & SCOOTER**

Aprilia	432.
Benelli	432.
beta	432.
Daelim	432.
Derbi	433.
Gilera	433.
Honda	433.
Hyosung	434.
Ibeston	434.
Italjet	434.
Kymco	435.
Malaguti	435.
MBK	435.
Moto Adly	435.
Moto Hispania	435.
Motonix	436.
Peugeot	436.
PGO	436.
Piaggio	436.
Rieju	436.
Sherco	436.
She-Lung	437.
Suzuki	437.
Sym	438.
TGB	438.
Yamaha	438.

# ENGINE

# PRODUCT OVERVIEW

## TOP-END

PISTON KITS, PISTON RINGS, PISTON PINS, PISTON CLIPS, NEEDLE BEARINGS, TOP END GASKET SETS, HEAD & BASE GASKETS SETS



- All kits include the piston pin, rings and clips
- Top End gaskets / Head & base gaskets available
- Piston pin needle bearing

## VALVE TRAIN COMPONENTS

STEEL & TITANIUM VALVES, TITANIUM TO STEEL CONVERSION KITS, VALVE STEM SEALS, SHIMS, CAM CHAINS



- Valves are manufactured of premium grade steel and titanium
- OEM quality seals and cam chains
- Valve shims Incremental sizes by 0.025 mm

## BOTTOM END

CONNECTING RODS, BEARINGS, WASHERS, PINS, CRANKSHAFTS, CRANKSHAFT BEARING & OIL SEALS, COMPLETE ENGINE GASKET SETS, WATERPUMP REVISION KITS, OILS FILTERS AND COUNTERSHAFT BEARING KITS



- Connecting Rod Kits are manufactured by leading Japanese OEM factories
- Single rod kit available where OEM only offers a complete crankshaft
- Our drop in crankshafts assemblies are precision trued to OEM specs
- High quality Koyo/NTN roller bearings in different clearance ratings



# ENGINE

## CLUTCH SYSTEM

CLUTCH BASKETS, INNER HUBS, PRESSURE PLATES, FRICTION & STEEL CLUTCH PLATES, SPRING KITS AND CLUTCH RUBBERS



- Complete clutch component program available
- Mainly Japanese clutch plates, inner hubs and pressure plates
- 10% stiffer springs to improve clutch performance and feel
- Forged clutch baskets with improved strength and stiffness

## PRODUCT OVERVIEW

## ENGINE GASKETS

COMPLETE ENGINE SETS, TOP END GASKET SETS, HEAD & BASE SETS, WATERPUMP REBUILD SETS, CLUTCH COVER GASKETS AND IGNITION COVER GASKETS

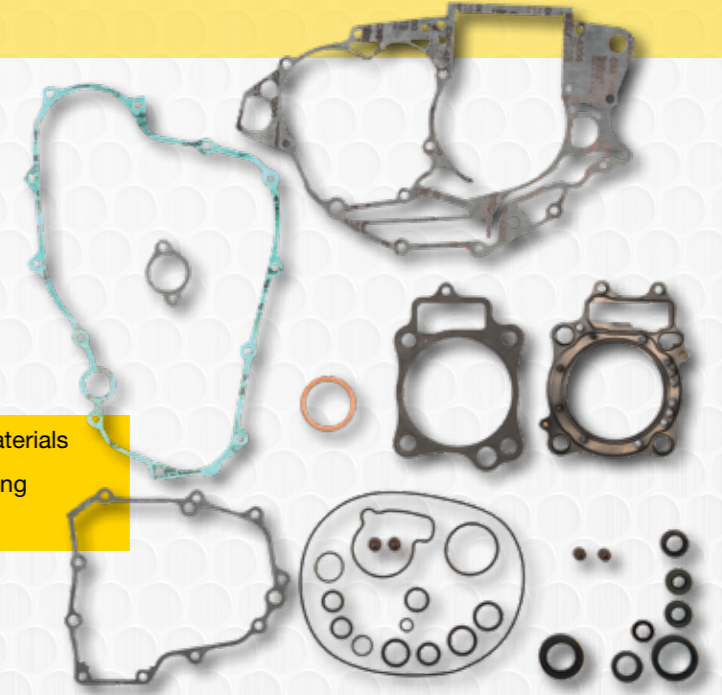

- Manufactured of premium paper, composite and metal materials
- Precision cut to guarantee optimal fitting and perfect sealing
- Super complete kits contain all rubber oil seals

## FUEL MANAGEMENT

CARBURETOR REBUILD KITS AND CARBURETOR JETS



- ProX jets are made in Japan to exact OEM specification
- Your cost efficient alternative for expensive original parts.
- ProX Carburetor rebuild kits are complete including needle and jet

# SERVICE

# PRODUCT OVERVIEW

## SUSPENSION SYSTEMS

FRONT FORK SEALS, DUST CAPS, BUSHING KITS, SHOCK BEARING KITS, REAR SHOCK SEAL HEAD KITS, SWINGARM BEARING KITS AND LINKAGE BEARING KITS

- All components you need in one kit
- NOK front fork seals and dust caps



## BRAKE PARTS

BRAKE DISKS, BRAKE PADS AND BRAKE REBUILD KITS



- High quality front & Rear brake pads
- Wave disc rotors for improved performance
- Brake Rebuild Kits contain all parts to revise your brake caliper

## TRANSMISSION PARTS

DRIVE CHAINS, FRONT SPROCKETS, REAR SPROCKETS, CHAIN ROLLERS AND COUNTERSHAFT SEAL KITS



- Aluminium and Ultra-Light steel rear sprockets
- High quality Japanese drive chains (Gold & Standard)
- Mud grooved front sprockets
- Chain rollers and more...

# SERVICE

## CABLES

CLUTCH CABLES AND THROTTLE CABLES



- Black PVC outer jacket for maximum flexibility and durability
- Steel inner casing, tightly coiled for low compression
- A pre-lubricated nylon inner sleeve guarantees smooth operation and long life
- Steel inner casing that is tightly coiled for low compression

## FILTERS

OIL FILTERS AND AIR FILTERS



- High quality filters manufactured from the finest materials
- Optimized to secure maximum flow

# PRODUCT OVERVIEW

## HOUR METERS

HOUR METERS WITH LOG BOOK, HOUR/TACH METERS AND HOUR/TACH METER BRACKETS



- ProX hour-tach meters feature the same as standard, plus:
  - Adjustable RPM input for dual or single spark ignition systems
  - Real-time reading of tach up to 20,000 rpm
- Wireless hour meters feature the same as standard, plus:
  - Easy installation!
  - No wires needed.

## PROMOTIONAL

DECALS, BANNERS, SPECIALTY ITEMS, PROFESSIONAL & PROMOTIONAL APPAREL





APRILIA

DIRT  
APRILIA  
BETA  
BMW  
GAS GAS  
HONDA  
HUSABERG  
HUSQVARNA  
KAWASAKI  
KTM  
MOTO TM  
RIEJU  
SHERCO  
SUZUKI  
YAMAHA

RXV 4.5 SXV 4.5 4-Stroke -Fuel Injection	Piston Kit -	Size 76.00	Ring Set -						
---	-----------------	---------------	---------------	--	--	--	--	--	--

RXV 5.5 SXV 5.5 4-Stroke -Fuel Injection	Piston Kit -	Size 80.00	Ring Set -						
---	-----------------	---------------	---------------	--	--	--	--	--	--

BETA

STREET  
APRILIA  
CAGIVA  
HONDA  
KAWASAKI  
KTM  
SUZUKI  
YAMAHA

RR 50 ENDURO 2-Stroke	Piston Kit 01.1010.130 01.1010.150 01.1010.175 01.1010.200 '05-20	Size 40.30 40.50 40.75 41.00	Ring Set - - 02.1010.175 02.1010.200 '05-20	Bearing 23.6303C3 '05-21 2x	S/E Bearing 21.7012 '05-21				
			Clips 05.1210C '05-20						

ATV-UTV  
CAN-AM  
GAS GAS  
HONDA  
KAWASAKI  
KTM  
POLARIS  
SUZUKI  
YAMAHA

RR 125 ENDURO 2T 2-Stroke Please Note: Nikasil Piston Size	Piston Kit 01.6226.A 01.6226.B 01.6226.C 01.6226.D 01.6226.E '18-23	Size 53.94 53.95 53.96 53.97 53.98	Ring Set 02.6225 02.6225 02.6225 02.6225 02.6225 '18-23	Oilseal Set 42.7218 '18-19 42.7220 '20-23	Con. Rod Kit 03.6220 '18-23  S/E Bearing 21.3206 '18-23  B/E Bearing 22.222816F '18-23  Crankpin 06.2255 '18-23  Washers 03W.22371.0 '18-23	Top-End 35.7218 '18-19 35.7220 '20-23  Head & Base 36.7218 '18-23			
			Pin 04.1545 '18-23  Clips 05.1510 '18-23						

PWC  
KAWASAKI  
POLARIS  
SEA DOO  
YAMAHA

SNOW  
ARCTIC CAT  
KAWASAKI  
LYNX  
MOTO-SKI  
POLARIS  
SKI DOO  
YAMAHA

MOPED & SCOOTER

MISC. TECH. SPECIAL

Footnotes: \* Bearings Only \*\* Rubbers included

DIRT  
APRILIA  
BETA  
BMW  
GAS GAS  
HONDA  
HUSABERG  
HUSQVARNA  
KAWASAKI  
KTM  
MOTO TM  
RIEJU  
SHERCO  
SUZUKI  
YAMAHA

STREET  
APRILIA  
CAGIVA  
HONDA  
KAWASAKI  
KTM  
SUZUKI  
YAMAHA

ATV-UTV  
CAN-AM  
GAS GAS  
HONDA  
KAWASAKI  
KTM  
POLARIS  
SUZUKI  
YAMAHA

PWC  
KAWASAKI  
POLARIS  
SEA DOO  
YAMAHA

SNOW  
ARCTIC CAT  
KAWASAKI  
LYNX  
MOTO-SKI  
POLARIS  
SKI DOO  
YAMAHA

MOPED & SCOOTER

MISC. TECH. SPECIAL

			F/W Bearing 23.S115070 '06-11  R/W Bearing 23.S114006 '06-11  Steering Bearing 24.110067 '06-11	Front Pad Set 37.103202 '06-11 37.103202BX '06-11 Box of 10  Rear Pad Set 37.201302 '06-11 37.201302BX '06-11 Box of 10		Chain 07.RC520120C '06-11 MX 07.RC520120CG '06-11 MX Gold 07.RC520120XC '06-11 X-Ring 07.RC520120XCG '06-11 X-Ring Gold			
--	--	--	---	---	--	---	--	--	--

						Chain 07.RC420130C '05-21 MX			
--	--	--	--	--	--	------------------------------------	--	--	--

Air Filter 52.63013 '18-19 52.63020 '20-23  Throttle Cable 53.112080 '18-23	Master Cylinder Rebuild Kit 16.940029 '19-21	Friction Set 16.S63001 '18-23  Steel Set 16.S72018 '18-23	F/W Bearing 23.S114002 '18-23  R/W Bearing 23.S114004 '18-23	Frontbrake Disc 37.BD16013 '18-23  Rearbrake Disc 37.BD26013 '18-23  Front Pad Set 37.103202 '18-23 37.103202BX '18-23 Box of 10  Rear Pad Set 37.201302 '18-23 37.201302BX '18-23 Box of 10	Front Sprocket 07.FS62093-12 07.FS62093-13 07.FS62093-14 07.FS62093-15 '18-23  7075-T6 Alloy Rear Sprocket 07.RA73013-48 07.RA73013-49 07.RA73013-50 07.RA73013-51 '18-23  Ultralight Steel Rear Sprocket 07.RS73013R-48 07.RS73013R-49 07.RS73013R-50 07.RS73013R-51 '18-23  Sprocket Bolt Set 07.SBSM825 '18-23	Chain 07.RC520120C '18-23 MX 07.RC520120CG '18-23 MX Gold 07.RC520120XC '18-23 X-Ring 07.RC520120XCG '18-23 X-Ring Gold	Swingarm 26.210125 '18-23  Linkage 26.110185 '18-23  Upper 26.350080 '18-22  Lower 26.450076 '18-23		
---	---	---	--	--	--	---	---	--	--

X logo



**PISTON KITS**



**SIZES (mm)**



**PISTON PARTS**



**CRANKSHAFT PARTS**



**CONNECTING ROD PARTS**



**GASKETS**



**VALVE TRAIN PARTS I**



**VALVE TRAIN PARTS II**



**AIR & FUEL PARTS**



**CLUTCH PARTS**



**CLUTCH PLATE SETS**



**WHEEL & STEERING PARTS**



**BRAKE PARTS**



**DRIVE CHAIN PARTS I**



**DRIVE CHAIN PARTS II**



**SUSPENSION BEARING KITS**



**SUSPENSION PARTS**



**BETA**

<b>DIRT</b> APRILIA BETA BMW GAS GAS HONDA HUSABERG HUSQVARNA KAWASAKI KTM MOTO TM RIEJU SHERCO SUZUKI YAMAHA	RR 200 ENDURO 2T 2-Stroke Please Note: Nikasil Piston Size	<b>Piston Kit</b> - '19-23	<b>Size</b> 62.00	<b>Ring Set</b> - '19-23	<b>Oilseal Set</b> 42.7220 '19-23		<b>Top-End</b> 35.7219 '19-23			
						<b>Head &amp; Base</b> 36.7219 '19-23				
<b>STREET</b> APRILIA CAGIVA HONDA KAWASAKI KTM SUZUKI YAMAHA	RR 250 ENDURO 2T 2-Stroke Please Note: Nikasil Piston Size -Forged Piston	<b>Piston Kit</b> 01.7313.A 01.7313.B 01.7313.C '13-21	<b>Size</b> 66.34 66.35 66.36	<b>Ring Set</b> 02.6324 02.6324 02.6324 '13-21  <b>Pin</b> 04.1856 '13-21  <b>Clips</b> 05.1812 '13-21	<b>Crank Bearing &amp; Seal Kit</b> 23.CBS73013 '13-21 23.CBS73022 '22-23  <b>Bearing</b> 23.TMB206 '13-21 2x 23.TMB206 '22-23 1x Right 23.NJ206 '22-23 1x Left  <b>Oilseal Set</b> 42.6320 '13-23	<b>Con. Rod Kit</b> 03.7313 '13-17 03.7318 '18-21 03.7322 '22-23  <b>S/E Bearing</b> 21.6320 '13-23  <b>B/E Bearing</b> 22.243117F '13-23  <b>Crankpin</b> 06.2459 '13-17 06.2459.1 '18-23	<b>Top-End</b> 35.7313 '13-21 35.7322 '22-23  <b>Head &amp; Base</b> 36.7313 '13-23			
<b>ATV-UTV</b> CAN-AM GAS GAS HONDA KAWASAKI KTM POLARIS SUZUKI YAMAHA	XTRAINER 250 2-Stroke Please Note: Nikasil Piston Size -Forged Piston	<b>Piston Kit</b> 01.7313.A 01.7313.B 01.7313.C '18-21	<b>Size</b> 66.34 66.35 66.36	<b>Ring Set</b> 02.6324 02.6324 02.6324 '18-21  <b>Pin</b> 04.1856 '18-21  <b>Clips</b> 05.1812 '18-21	<b>Crank Bearing &amp; Seal Kit</b> 23.CBS73013 '18-21 23.CBS73022 '22-23  <b>Bearing</b> 23.TMB206 '18-21 2x 23.TMB206 '22-23 1x Right 23.NJ206 '22-23 1x Left  <b>Oilseal Set</b> 42.6320 '18-23	<b>Con. Rod Kit</b> 03.7318 '18-21 03.7322 '22-23  <b>S/E Bearing</b> 21.6320 '18-23  <b>B/E Bearing</b> 22.243117F '18-23  <b>Crankpin</b> 06.2459.1 '18-23	<b>Top-End</b> 35.7313 '18-21 35.7322 '22-23  <b>Head &amp; Base</b> 36.7313 '18-23			
<b>SNOW</b> ARCTIC CAT KAWASAKI LYNX MOTO-SKI POLARIS SKI DOO YAMAHA	XTRAINER 250 2-Stroke Please Note: Nikasil Piston Size -Forged Piston	<b>Piston Kit</b> 01.7313.A 01.7313.B 01.7313.C '18-21	<b>Size</b> 66.34 66.35 66.36	<b>Ring Set</b> 02.6324 02.6324 02.6324 '18-21  <b>Pin</b> 04.1856 '18-21  <b>Clips</b> 05.1812 '18-21	<b>Crank Bearing &amp; Seal Kit</b> 23.CBS73013 '18-21 23.CBS73022 '22-23  <b>Bearing</b> 23.TMB206 '18-21 2x 23.TMB206 '22-23 1x Right 23.NJ206 '22-23 1x Left  <b>Oilseal Set</b> 42.6320 '18-23	<b>Con. Rod Kit</b> 03.7318 '18-21 03.7322 '22-23  <b>S/E Bearing</b> 21.6320 '18-23  <b>B/E Bearing</b> 22.243117F '18-23  <b>Crankpin</b> 06.2459.1 '18-23	<b>Top-End</b> 35.7313 '18-21 35.7322 '22-23  <b>Head &amp; Base</b> 36.7313 '18-23			
<b>MOPED &amp; SCOOTER</b>										
<b>MISC. TECH. SPECIAL</b>										

Footnotes: \* Bearings Only \*\* Rubbers included

<b>Air Filter</b> 52.63013 '19 52.63020 '20-23  <b>Throttle Cable</b> 53.112080 '19-23	<b>Master Cylinder Rebuild Kit</b> 16.940029 '19-23	<b>Friction Set</b> 16.S63001 '19-23	<b>F/W Bearing</b> 23.S114002 '19-23  <b>R/W Bearing</b> 23.S114004 '19-23	<b>Frontbrake Disc</b> 37.BD16013 '19-23  <b>Rearbrake Disc</b> 37.BD26013 '19-23  <b>Front Pad Set</b> 37.103202 '19-23 37.103202BX '19-23 Box of 10  <b>Rear Pad Set</b> 37.201302 '19-23 37.201302BX '19-23 Box of 10	<b>Front Sprocket</b> 07.FS62093-12 07.FS62093-13 07.FS62093-14 07.FS62093-15 '19-23  <b>7075-T6 Alloy Rear Sprocket</b> 07.RA73013-48 07.RA73013-49 07.RA73013-50 07.RA73013-51 '19-23  <b>Ultralight Steel Rear Sprocket</b> 07.RS73013R-48 07.RS73013R-49 07.RS73013R-50 07.RS73013R-51 '19-23  <b>Sprocket Bolt Set</b> 07.SBSM825 '19-23	<b>Chain</b> 07.RC520120C '19-23 MX 07.RC520120CG '19-23 MX Gold 07.RC520120XC '19-23 X-Ring 07.RC520120XCG '19-23 X-Ring Gold	<b>Swingarm</b> 26.210125 '19-23  <b>Linkage</b> 26.110185 '19-23  <b>Upper</b> 26.350080 '19-22  <b>Lower</b> 26.450076 '19-23
<b>Air Filter</b> 52.63013 '13-19 52.63020 '20-23  <b>Main Jet</b> 45.100-225 '13-23 Keihin  <b>Pilot Jet</b> 46.040-085 '13-23 Keihin  <b>Throttle Cable</b> 53.112080 '13-23	<b>Spring Kit</b> 17.CS73013 '13-17  <b>Master Cylinder Rebuild Kit</b> 16.940029 '13-23	<b>Friction Set</b> 16.S73013 '13-17 16.S73028 '18-23	<b>F/W Bearing</b> 23.S114002 '13-23  <b>R/W Bearing</b> 23.S114004 '13-23  <b>Steering Bearing</b> 24.110026 '13-17	<b>Frontbrake Disc</b> 37.BD16013 '13-23  <b>Rearbrake Disc</b> 37.BD26013 '13-23  <b>Front Pad Set</b> 37.103202 '13-23 37.103202BX '13-23 Box of 10  <b>Rear Pad Set</b> 37.201302 '13-23 37.201302BX '13-23 Box of 10	<b>Front Sprocket</b> 07.FS62093-12 07.FS62093-13 07.FS62093-14 07.FS62093-15 '13-23  <b>7075-T6 Alloy Rear Sprocket</b> 07.RA73013-48 07.RA73013-49 07.RA73013-50 07.RA73013-51 '13-23  <b>Ultralight Steel Rear Sprocket</b> 07.RS73013R-48 07.RS73013R-49 07.RS73013R-50 07.RS73013R-51 '13-23  <b>Sprocket Bolt Set</b> 07.SBSM825 '13-23	<b>Chain</b> 07.RC520120C '13-23 MX 07.RC520120CG '13-23 MX Gold 07.RC520120XC '13-23 X-Ring 07.RC520120XCG '13-23 X-Ring Gold	<b>Swingarm</b> 26.210125 '13-23  <b>Linkage</b> 26.110185 '13-23  <b>Upper</b> 26.350080 '13-22  <b>Lower</b> 26.450076 '13-23
<b>Air Filter</b> 52.63013 '18-22 52.63020 '23	<b>Master Cylinder Rebuild Kit</b> 16.940029 '18-23	<b>Friction Set</b> 16.S73028 '18-23	<b>F/W Bearing</b> 23.S114002 '18-23  <b>R/W Bearing</b> 23.S114004 '18-23	<b>Frontbrake Disc</b> 37.BD16013 '18-23  <b>Rearbrake Disc</b> 37.BD26013 '18-23  <b>Front Pad Set</b> 37.103202 '18-23 37.103202BX '18-23 Box of 10  <b>Rear Pad Set</b> 37.201302 '18-23 37.201302BX '18-23 Box of 10	<b>Front Sprocket</b> 07.FS62093-12 07.FS62093-13 07.FS62093-14 07.FS62093-15 '18-23  <b>7075-T6 Alloy Rear Sprocket</b> 07.RA73013-48 07.RA73013-49 07.RA73013-50 07.RA73013-51 '18-23  <b>Ultralight Steel Rear Sprocket</b> 07.RS73013R-48 07.RS73013R-49 07.RS73013R-50 07.RS73013R-51 '18-23  <b>Sprocket Bolt Set</b> 07.SBSM825 '18-23	<b>Chain</b> 07.RC520120C '18-23 MX 07.RC520120CG '18-23 MX Gold 07.RC520120XC '18-23 X-Ring 07.RC520120XCG '18-23 X-Ring Gold	<b>Swingarm</b> 26.210125 '18-23  <b>Linkage</b> 26.110185 '18-23  <b>Upper</b> 26.350081 '18-23  <b>Lower</b> 26.450076 '18-23

<b>DIRT</b> APRILIA BETA BMW GAS GAS HONDA HUSABERG HUSQVARNA KAWASAKI KTM MOTO TM RIEJU SHERCO SUZUKI YAMAHA										
<b>STREET</b> APRILIA CAGIVA HONDA KAWASAKI KTM SUZUKI YAMAHA										
<b>ATV-UTV</b> CAN-AM GAS GAS HONDA KAWASAKI KTM POLARIS SUZUKI YAMAHA										
<b>PWC</b> KAWASAKI POLARIS SEA DOO YAMAHA										
<b>SNOW</b> ARCTIC CAT KAWASAKI LYNX MOTO-SKI POLARIS SKI DOO YAMAHA										
<b>MOPED &amp; SCOOTER</b>										
<b>MISC. TECH. SPECIAL</b>										





BETA

DIRT  
APRILIA  
BETA  
BMW  
GAS GAS  
HONDA  
HUSABERG  
HUSQVARNA  
KAWASAKI  
KTM  
MOTO TM  
RIEJU  
SHERCO  
SUZUKI  
YAMAHA

RR 250 ENDURO 4-Stroke Please Note: Nikasil Piston Size -Forged Piston  Replating or Cylinder Sleaving Required for Oversizes	<b>Piston Kit</b> - & 01.6301.200 '05-07	<b>Size</b> 75.00	<b>Ring Set</b> - 02.6301.200 '05-07	<b>CrankBearing &amp; Seal Kit</b> 23.CBS64003 '05-07  <b>Bearing</b> 23.NJ206ECP-1 '05-07 2x	<b>Con. Rod Kit</b> 03.6520 '05-07  <b>B/E Bearing</b> 22.354322F '05-07  <b>Crankpin</b> 06.3564.7 '05-07				
---	--	----------------------	---	---	--	--	--	--	--

STREET  
APRILIA  
CAGIVA  
HONDA  
KAWASAKI  
KTM  
SUZUKI  
YAMAHA

RX 300 2-Stroke Please Note: Nikasil Piston Size -Forged Piston	<b>Piston Kit</b> 01.7398.A 01.7398.B 01.7398.C '21-23	<b>Size</b> 71.94 71.95 71.96	<b>Ring Set</b> 02.6396 02.6396 02.6396 '21-23  <b>Clips</b> 05.1812 '21-23	<b>CrankBearing &amp; Seal Kit</b> 23.CBS73013 '21-23  <b>Bearing</b> 23.TMB206 '21-23 2x  <b>Oilseal Set</b> 42.6320 '21-23	<b>Con. Rod Kit</b> 03.7318 '21-23  <b>S/E Bearing</b> 21.6320 '21-23  <b>B/E Bearing</b> 22.243117F '21-23  <b>Crankpin</b> 06.2459.1 '21-23	<b>Top-End</b> 35.7323 '21-23  <b>Head &amp; Base</b> 36.7323 '21-23			
---	--	--	---	--	---	--	--	--	--

PWC  
KAWASAKI  
POLARIS  
SEA DOO  
YAMAHA

RR 300 ENDURO 2T 2-Stroke Please Note: Nikasil Piston Size -Forged Piston  Please Note: Nikasil Piston Size -Forged Piston  Please Note: Nikasil Piston Size -Forged Piston	<b>Piston Kit</b> 01.7393.A 01.7393.B 01.7393.C '13-17  01.7398.A 01.7398.B 01.7398.C '18-21  NEW '22-23	<b>Size</b> 71.94 71.95 71.96  71.94 71.95 71.96  73.00	<b>Ring Set</b> 02.6396 02.6396 02.6396 '13-21  02.6396 02.6396 02.6396 '13-21  NEW '22-23  <b>Pin</b> 04.1857 '13-17  <b>Clips</b> 05.1812 '13-21	<b>CrankBearing &amp; Seal Kit</b> 23.CBS73013 '13-23  <b>Bearing</b> 23.TMB206 '13-23 2x  <b>Oilseal Set</b> 42.6320 '13-23	<b>Con. Rod Kit</b> 03.7313 '13-17 03.7318 '18-21 03.7322 '22-23  <b>S/E Bearing</b> 21.6320 '13-23  <b>B/E Bearing</b> 22.243117F '13-23  <b>Crankpin</b> 06.2459 '13-17 06.2459.1 '18-23	<b>Top-End</b> 35.7323 '13-21 35.7332 '22-23  <b>Head &amp; Base</b> 36.7323 '13-23			
---	--	--	--	--	--	---	--	--	--

MOPED & SCOOTER

MISC. TECH. SPECIAL

Footnotes: \* Bearings Only \*\* Rubbers included

DIRT  
APRILIA  
BETA  
BMW  
GAS GAS  
HONDA  
HUSABERG  
HUSQVARNA  
KAWASAKI  
KTM  
MOTO TM  
RIEJU  
SHERCO  
SUZUKI  
YAMAHA

STREET  
APRILIA  
CAGIVA  
HONDA  
KAWASAKI  
KTM  
SUZUKI  
YAMAHA

ATV-UTV  
CAN-AM  
GAS GAS  
HONDA  
KAWASAKI  
KTM  
POLARIS  
SUZUKI  
YAMAHA

PWC  
KAWASAKI  
POLARIS  
SEA DOO  
YAMAHA

SNOW  
ARCTIC CAT  
KAWASAKI  
LYNX  
MOTO-SKI  
POLARIS  
SKI DOO  
YAMAHA

MOPED & SCOOTER

MISC. TECH. SPECIAL

<b>Air Filter</b> 52.63005 '05-07  <b>Main Jet</b> 45.100-225 '05-07 Keihin  <b>Pilot Jet</b> 46.040-085 '05-07 Keihin  <b>Oil Filter #1</b> 54.63655 '05-07 1-Pce. 54.63655-50 '05-07 50-Pcs.  <b>Oil Filter #2</b> 54.64157 '05-07 1-Pce. 54.64157-50 '05-07 50-Pcs.	<b>Spring Kit</b> 17.CS65041 '05-07  <b>Friction Set</b> 16.S54007 '05-07  <b>Steel Set</b> 16.S54009 '05-07	<b>Complete Plate Set</b> 16.CPS64104 '05-07	<b>F/W Bearing</b> 23.S114002 '05-07	<b>Front Pad Set</b> 37.103202 '05-07 37.103202BX '05-07 Box of 10  <b>Rear Pad Set</b> 37.201302 '05-07 37.201302BX '05-07 Box of 10	<b>Front Sprocket</b> 07.FS62093-12 07.FS62093-13 07.FS62093-14 07.FS62093-15 '05-07  <b>7075-T6 Alloy Rear Sprocket</b> 07.RA62097-46 07.RA62097-47 07.RA62097-48 07.RA62097-49 07.RA62097-50 07.RA62097-51 07.RA62097-52 '05-07  <b>Ultralight Steel Rear Sprocket</b> 07.RS62097R-46 07.RS62097R-47 07.RS62097R-48 07.RS62097R-49 07.RS62097R-50 07.RS62097R-51 07.RS62097R-52 '05-07  <b>Sprocket Bolt Set</b> 07.SBSM825 '05-07	<b>Chain</b> 07.RC520120C '05-07 MX 07.RC520120CG '05-07 MX Gold 07.RC520120XC '05-07 X-Ring 07.RC520120XCG '05-07 X-Ring Gold	<b>Swingarm</b> 26.210125 '05-07  <b>Linkage</b> 26.110185 '05-07  <b>Upper</b> 26.350080 '05-07  <b>Lower</b> 26.450076 '05-07
--	--	--	--	---	---	--	---

<b>Air Filter</b> 52.63020 '21-23  <b>Main Jet</b> 45.100-225 '21-23 Keihin  <b>Pilot Jet</b> 46.040-085 '21-23 Keihin  <b>Throttle Cable</b> 53.112080 '21-23		<b>Friction Set</b> 16.S73028 '21-23	<b>F/W Bearing</b> 23.S114002 '21-23  <b>R/W Bearing</b> 23.S114004 '21-23	<b>Frontbrake Disc</b> 37.BD16013 '21-23  <b>Rearbrake Disc</b> 37.BD26013 '21-23  <b>Front Pad Set</b> 37.103202 '21-23 37.103202BX '21-23 Box of 10  <b>Rear Pad Set</b> 37.201302 '21-23 37.201302BX '21-23 Box of 10	<b>Front Sprocket</b> 07.FS62093-12 07.FS62093-13 07.FS62093-14 07.FS62093-15 '21-23  <b>7075-T6 Alloy Rear Sprocket</b> 07.RA73013-48 07.RA73013-49 07.RA73013-50 07.RA73013-51 '21-23  <b>Ultralight Steel Rear Sprocket</b> 07.RS73013R-48 07.RS73013R-49 07.RS73013R-50 07.RS73013R-51 '21-23  <b>Sprocket Bolt Set</b> 07.SBSM825 '21-23	<b>Chain</b> 07.RC520120C '21-23 MX 07.RC520120CG '21-23 MX Gold 07.RC520120XC '21-23 X-Ring 07.RC520120XCG '21-23 X-Ring Gold	<b>Swingarm</b> 26.210125 '21-23  <b>Linkage</b> 26.110185 '21-23  <b>Upper</b> 26.350080 '21-23  <b>Lower</b> 26.450076 '21-23
--	--	--	--	--	--	--	---

<b>Air Filter</b> 52.63013 '13-19 52.63020 '20-23  <b>Main Jet</b> 45.100-225 '13-23 Keihin  <b>Pilot Jet</b> 46.040-085 '13-23 Keihin  <b>Throttle Cable</b> 53.112080 '13-23	<b>Spring Kit</b> 17.CS73013 '13-17  <b>Master Cylinder Rebuild Kit</b> 16.940029 '13-23	<b>Friction Set</b> 16.S73013 '13-17 16.S73028 '18-23	<b>F/W Bearing</b> 23.S114002 '13-23  <b>R/W Bearing</b> 23.S114004 '13-23  <b>Steering Bearing</b> 24.110026 '13-17	<b>Frontbrake Disc</b> 37.BD16013 '13-23  <b>Rearbrake Disc</b> 37.BD26013 '13-23  <b>Front Pad Set</b> 37.103202 '13-23 37.103202BX '13-23 Box of 10  <b>Rear Pad Set</b> 37.201302 '13-23 37.201302BX '13-23 Box of 10	<b>Front Sprocket</b> 07.FS62093-12 07.FS62093-13 07.FS62093-14 07.FS62093-15 '13-23  <b>7075-T6 Alloy Rear Sprocket</b> 07.RA73013-48 07.RA73013-49 07.RA73013-50 07.RA73013-51 '13-23  <b>Ultralight Steel Rear Sprocket</b> 07.RS73013R-48 07.RS73013R-49 07.RS73013R-50 07.RS73013R-51 '13-23  <b>Sprocket Bolt Set</b> 07.SBSM825 '13-23	<b>Chain</b> 07.RC520120C '13-23 MX 07.RC520120CG '13-23 MX Gold 07.RC520120XC '13-23 X-Ring 07.RC520120XCG '13-23 X-Ring Gold	<b>Swingarm</b> 26.210125 '13-23  <b>Linkage</b> 26.110185 '13-23  <b>Upper</b> 26.350080 '13-22  <b>Lower</b> 26.450076 '13-23
--	--	---	--	--	--	--	---

DIRT  
APRILIA  
BETA  
BMW  
GAS GAS  
HONDA  
HUSABERG  
HUSQVARNA  
KAWASAKI  
KTM  
MOTO TM  
RIEJU  
SHERCO  
SUZUKI  
YAMAHA

STREET  
APRILIA  
CAGIVA  
HONDA  
KAWASAKI  
KTM  
SUZUKI  
YAMAHA

ATV-UTV  
CAN-AM  
GAS GAS  
HONDA  
KAWASAKI  
KTM  
POLARIS  
SUZUKI  
YAMAHA

PWC  
KAWASAKI  
POLARIS  
SEA DOO  
YAMAHA

SNOW  
ARCTIC CAT  
KAWASAKI  
LYNX  
MOTO-SKI  
POLARIS  
SKI DOO  
YAMAHA

MOPED & SCOOTER

MISC. TECH. SPECIAL



**BETA**

**DIRT**  
APRILIA  
**BETA**  
BMW  
GAS GAS  
HONDA  
HUSABERG  
HUSQVARNA  
KAWASAKI  
KTM  
MOTO TM  
RIEJU  
SHERCO  
SUZUKI  
YAMAHA

XTRAINER 300 2-Stroke Please Note: Nikasil Piston Size -Forged Piston	<b>Piston Kit</b> 01.7393.A 01.7393.B 01.7393.C '15-17	<b>Size</b> 71.94 71.95 71.96	<b>Ring Set</b> 02.6396 02.6396 02.6396 '15-21	<b>Crank Bearing &amp; Seal Kit</b> 23.CBS73013 '15-23	<b>Con. Rod Kit</b> 03.7313 '15-17 03.7318 '18-21 03.7322 '22-23	<b>Top-End</b> 35.7323 '15-21 35.7332 '22-23		
Please Note: Nikasil Piston Size -Forged Piston	01.7398.A 01.7398.B 01.7398.C '18-21	71.94 71.95 71.96	02.6396 02.6396 02.6396 '15-21	<b>Bearing</b> 23.TMB206 '15-23 2x	<b>S/E Bearing</b> 21.6320 '15-23	<b>Head &amp; Base</b> 36.7323 '15-23		
Please Note: Nikasil Piston Size -Forged Piston	NEW '22	73.00	NEW '22	<b>Oilseal Set</b> 42.6320 '15-23	<b>B/E Bearing</b> 22.243117F '15-23			
			<b>Pin</b> 04.1857 '15-17		<b>Crankpin</b> 06.2459 '15-17 06.2459.1 '18-23			
			<b>Clips</b> 05.1812 '15-21					

**STREET**  
APRILIA  
CAGIVA  
HONDA  
KAWASAKI  
KTM  
SUZUKI  
YAMAHA

RR 350 ENDURO 4-Stroke Please Note: Nikasil Piston Size -Std. Compression 12.9:1 -Forged Piston	<b>Piston Kit</b> 01.7351.A 01.7351.B 01.7351.C '11-14	<b>Size</b> 87.96 87.97 87.98	<b>Ring Set</b> 02.6351 02.6351 02.6351 '11-14	<b>Crank Bearing &amp; Seal Kit</b> 23.CBS73050 '11-23		<b>Top-End</b> 35.7351 '11-19 35.7360 '20-23	<b>Cam Chain</b> 31.1900 '11-23	
Please Note: Nikasil Piston Size -Std. Compression 13.2:1 -Fuel Injection	01.7355.A 01.7355.B 01.7355.C '15-23	87.96 87.97 87.98	TBA TBA TBA '15-23	<b>Bearing</b> 23.SX07E39 '11-23 2x		<b>Head &amp; Base</b> 36.7351 '11-19 36.7360 '20-23	<b>Valve Shim Assortment</b> 29.VSA1000 '11-23 29.VSA1000-2 '11-23	

**ATV-UTV**  
CAN-AM  
GAS GAS  
HONDA  
KAWASAKI  
KTM  
POLARIS  
SUZUKI  
YAMAHA

			<b>Pin</b> 04.1844.4 '11-14					
			<b>Clips</b> 05.1812 '11-14					

**PWC**  
KAWASAKI  
POLARIS  
SEA DOO  
YAMAHA

--	--	--	--	--	--	--	--	--

**SNOW**  
ARCTIC CAT  
KAWASAKI  
LYNX  
MOTO-SKI  
POLARIS  
SKI DOO  
YAMAHA

--	--	--	--	--	--	--	--	--

**MOPED & SCOOTER**

--	--	--	--	--	--	--	--	--

**MISC. TECH. SPECIAL**

--	--	--	--	--	--	--	--	--

Footnotes: \* Bearings Only \*\* Rubbers included

<b>Air Filter</b> 52.63013 '15-22 52.63020 '23	<b>Spring Kit</b> 17.CS73013 '15-17	<b>Friction Set</b> 16.S24041 '15-17 16.S73028 '18-23	<b>F/W Bearing</b> 23.S114002 '15-23	<b>Frontbrake Disc</b> 37.BD16013 '15-23	<b>Front Sprocket</b> 07.FS62093-12 07.FS62093-13 07.FS62093-14 07.FS62093-15 '15-23	<b>Chain</b> 07.RC520120C '15-23 MX 07.RC520120CG '15-23 MX Gold 07.RC520120XC '15-23 X-Ring 07.RC520120XCG '15-23 X-Ring Gold	<b>Swingarm</b> 26.210125 '15-23
<b>Main Jet</b> 45.100-225 '15-23 Keihin	<b>Master Cylinder Rebuild Kit</b> 16.940029 '15-23		<b>R/W Bearing</b> 23.S114004 '15-23	<b>Rearbrake Disc</b> 37.BD26013 '15-23	<b>7075-T6 Alloy Rear Sprocket</b> 07.RA73013-48 07.RA73013-49 07.RA73013-50 07.RA73013-51 '15-23		<b>Linkage</b> 26.110185 '15-23
<b>Pilot Jet</b> 46.040-085 '15-23 Keihin				<b>Front Pad Set</b> 37.103202 '15-23			<b>Upper</b> 26.350081 '15-23
<b>Throttle Cable</b> 53.112081 '15-23				<b>Rear Pad Set</b> 37.201302 '15-23	<b>Ultralight Steel Rear Sprocket</b> 07.RS73013R-48 07.RS73013R-49 07.RS73013R-50 07.RS73013R-51 '15-23		<b>Lower</b> 26.450076 '15-23
				<b>Rear Pad Set</b> 37.201302 '15-23			
				<b>Sprocket Bolt Set</b> 07.SBSM825 '15-23			

<b>Air Filter</b> 52.63005 '11-12 52.63013 '13-19 52.63020 '20-23	<b>Spring Kit</b> 17.CS73013 '11-17	<b>Friction Set</b> 16.S73013 '11-17 16.S73028 '18-23	<b>F/W Bearing</b> 23.S114002 '11-23	<b>Frontbrake Disc</b> 37.BD16013 '13-23	<b>Front Sprocket</b> 07.FS62093-12 07.FS62093-13 07.FS62093-14 07.FS62093-15 '11-23	<b>Chain</b> 07.RC520120C '11-23 MX 07.RC520120CG '11-23 MX Gold 07.RC520120XC '11-23 X-Ring 07.RC520120XCG '11-23 X-Ring Gold	<b>Swingarm</b> 26.210125 '11-23
<b>Main Jet</b> 45.100-225 '11-14 Keihin	<b>Master Cylinder Rebuild Kit</b> 16.940029 '12-23		<b>R/W Bearing</b> 23.S114004 '11-23	<b>Rearbrake Disc</b> 37.BD26013 '13-23	<b>7075-T6 Alloy Rear Sprocket</b> 07.RA62097-46 07.RA62097-47 07.RA62097-48 07.RA62097-49 07.RA62097-50 07.RA62097-51 07.RA62097-52 '11-12		<b>Linkage</b> 26.110185 '11-23
<b>Pilot Jet</b> 46.040-085 '11-14 Keihin			<b>Steering Bearing</b> 24.110026 '11-17	<b>Front Pad Set</b> 37.103202 '11-23 37.103202BX '11-23 Box of 10			<b>Upper</b> 26.350080 '11-22
<b>Oil Filter</b> 54.64631 '11-23 1-Pce. 54.64631-50 '11-23 50-Pcs.				<b>Rear Pad Set</b> 37.201302 '11-23 37.201302BX '11-23 Box of 10			<b>Lower</b> 26.450076 '11-23
<b>Throttle Cable</b> 53.112082 '11-14 53.112083 '15-19 53.112084 '20-23					<b>Ultralight Steel Rear Sprocket</b> 07.RS62097R-46 07.RS62097R-47 07.RS62097R-48 07.RS62097R-49 07.RS62097R-50 07.RS62097R-51 07.RS62097R-52 '11-12		
					<b>Ultralight Steel Rear Sprocket</b> 07.RS73013R-48 07.RS73013R-49 07.RS73013R-50 07.RS73013R-51 '13-23		
					<b>Sprocket Bolt Set</b> 07.SBSM825 '11-23		

**DIRT**  
APRILIA  
**BETA**  
BMW  
GAS GAS  
HONDA  
HUSABERG  
HUSQVARNA  
KAWASAKI  
KTM  
MOTO TM  
RIEJU  
SHERCO  
SUZUKI  
YAMAHA

**STREET**  
APRILIA  
CAGIVA  
HONDA  
KAWASAKI  
KTM  
SUZUKI  
YAMAHA

**ATV-UTV**  
CAN-AM  
GAS GAS  
HONDA  
KAWASAKI  
KTM  
POLARIS  
SUZUKI  
YAMAHA

**PWC**  
KAWASAKI  
POLARIS  
SEA DOO  
YAMAHA

**SNOW**  
ARCTIC CAT  
KAWASAKI  
LYNX  
MOTO-SKI  
POLARIS  
SKI DOO  
YAMAHA

**MOPED & SCOOTER**

**MISC. TECH. SPECIAL**







BETA

DIRT  
APRILIA  
BETA  
BMW  
GAS GAS  
HONDA  
HUSABERG  
HUSQVARNA  
KAWASAKI  
KTM  
MOTO TM  
RIEJU  
SHERCO  
SUZUKI  
YAMAHA

STREET  
APRILIA  
CAGIVA  
HONDA  
KAWASAKI  
KTM  
SUZUKI  
YAMAHA

ATV-UTV  
CAN-AM  
GAS GAS  
HONDA  
KAWASAKI  
KTM  
POLARIS  
SUZUKI  
YAMAHA

PWC  
KAWASAKI  
POLARIS  
SEA DOO  
YAMAHA

SNOW  
ARCTIC CAT  
KAWASAKI  
LYNX  
MOTO-SKI  
POLARIS  
SKI DOO  
YAMAHA

MOPED & SCOOTER

MISC. TECH. SPECIAL

RR 430 ENDURO 4-Stroke Please Note: Nikasil Piston Size -Std. Compression 11.9:1 -Fuel Injection From 2016 -Forged Piston	<b>Piston Kit</b> 01.7415.A 01.7415.B 01.7415.C '15-23	<b>Size</b> 94.96 94.97 94.98	<b>Ring Set</b> TBA TBA TBA '15-23	<b>CrankBearing &amp; Seal Kit</b> 23.CBS73050 '15-23  <b>Bearing</b> 23.SX07E39 '15-23 2x  <b>Oilseal Set</b> 42.7350 '15-23		<b>Top-End</b> 35.7416 '16-19 35.7420 '20-23  <b>Head &amp; Base</b> 36.7416 '16-19 36.7420 '20-23	<b>Cam Chain</b> 31.1900 '15-23  <b>Valve Shim Assortment</b> 29.VSA1000 '15-23 29.VSA1000-2 '15-23	
RR 450 ENDURO 4-Stroke Please Note: Nikasil Piston Size -Forged Piston	<b>Piston Kit</b> 01.6413.A 01.6413.B 01.6413.C '05-09	<b>Size</b> 88.95 88.96 88.97	<b>Ring Set</b> 02.6413 02.6413 02.6413 '05-09	<b>CrankBearing &amp; Seal Kit</b> 23.CBS64003 '05-09 23.CBS73050 '10-14  <b>Bearing</b> 23.NJ206ECP-1 '05-09 2x 23.SX07E39 '10-14 2x  <b>Oilseal Set</b> 42.7350 '10-14	<b>Con. Rod Kit</b> 03.6520 '05-09  <b>B/E Bearing</b> 22.354322F '05-09  <b>Crankpin</b> 06.3564.7 '05-09	<b>Cam Chain</b> 31.1993 '10-14  <b>Valve Shim Assortment</b> 29.VSA1000 '10-14 29.VSA1000-2 '10-14	<b>Valve</b> 28.6520-1 '05-09 2x Exhaust Steel 28.6520-2 '05-09 2x Intake Steel  <b>Valve Seal</b> 35.VS026 '05-09 4x	
	<b>Pin</b> 04.2045 '10-14  <b>Clips</b> 05.2012 '05-14	<b>Size</b> 94.95 94.96 94.97	<b>Ring Set</b> 02.6429 02.6429 02.6429 '10-14					

Footnotes: \* Bearings Only \*\* Rubbers included

<b>Air Filter</b> 52.63013 '15-19 52.63020 '20-23  <b>Main Jet</b> 45.100-225 '15 Keihin  <b>Pilot Jet</b> 46.040-085 '15 Keihin  <b>Oil Filter</b> 54.64631 '15-23 1-Pce. 54.64631-50 '15-23 50-Pcs.  <b>Throttle Cable</b> 53.112082 '15 53.112083 '16-19 53.112084 '20-23	<b>Spring Kit</b> 17.CS73013 '15-17  <b>Master Cylinder Rebuild Kit</b> 16.940029 '15-23	<b>Friction Set</b> 16.S73013 '15-17 16.S73028 '18-23	<b>F/W Bearing</b> 23.S114002 '15-23  <b>R/W Bearing</b> 23.S114004 '15-23  <b>Steering Bearing</b> 24.110026 '15-17	<b>Frontbrake Disc</b> 37.BD16013 '15-23  <b>Rearbrake Disc</b> 37.BD26013 '15-23  <b>Front Pad Set</b> 37.103202 '15-23 37.103202BX '15-23 Box of 10  <b>Rear Pad Set</b> 37.201302 '15-23 37.201302BX '15-23 Box of 10	<b>Front Sprocket</b> 07.FS62093-12 07.FS62093-13 07.FS62093-14 07.FS62093-15 '15-23  <b>7075-T6 Alloy Rear Sprocket</b> 07.RA73013-48 07.RA73013-49 07.RA73013-50 07.RA73013-51 '15-23  <b>Ultralight Steel Rear Sprocket</b> 07.RS73013R-48 07.RS73013R-49 07.RS73013R-50 07.RS73013R-51 '15-23  <b>Sprocket Bolt Set</b> 07.SBSM825 '15-23	<b>Chain</b> 07.RC520120C '15-23 MX 07.RC520120CG '15-23 MX Gold 07.RC520120XC '15-23 X-Ring 07.RC520120XCG '15-23 X-Ring Gold	<b>Swingarm</b> 26.210125 '15-23  <b>Linkage</b> 26.110185 '15-23  <b>Upper</b> 26.350080 '15-22  <b>Lower</b> 26.450076 '15-23
<b>Air Filter</b> 52.63005 '05-12 52.63013 '13-14  <b>Main Jet</b> 45.100-225 '05-14 Keihin  <b>Pilot Jet</b> 46.040-085 '05-14 Keihin  <b>Oil Filter #1</b> 54.63655 '05-09 1-Pce. 54.63655-50 '05-09 50-Pcs. 54.64631 '10-14 1-Pce. 54.64631-50 '10-14 50-Pcs.  <b>Oil Filter #2</b> 54.64157 '05-09 1-Pce. 54.64157-50 '05-09 50-Pcs.  <b>Throttle Cable</b> 53.112082 '10-14	<b>Spring Kit</b> 17.CS65041 '05-09  <b>Master Cylinder Rebuild Kit</b> 16.940029 '12-14	<b>Friction Set</b> 16.S54007 '05-09 16.S73013 '12-14  <b>Steel Set</b> 16.S54009 '05 16.S54010 '06-09	<b>F/W Bearing</b> 23.S114002 '05-14  <b>R/W Bearing</b> 23.S114004 '11-14  <b>Steering Bearing</b> 24.110026 '05-14	<b>Frontbrake Disc</b> 37.BD16013 '13-14  <b>Rearbrake Disc</b> 37.BD26013 '13-14  <b>Front Pad Set</b> 37.103202 '05-14 37.103202BX '05-14 Box of 10  <b>Rear Pad Set</b> 37.201302 '05-14 37.201302BX '05-14 Box of 10	<b>Front Sprocket</b> 07.FS62093-12 07.FS62093-13 07.FS62093-14 07.FS62093-15 '05-14  <b>7075-T6 Alloy Rear Sprocket</b> 07.RA62097-46 07.RA62097-47 07.RA62097-48 07.RA62097-49 07.RA62097-50 07.RA62097-51 07.RA62097-52 '05-12  07.RA73013-48 07.RA73013-49 07.RA73013-50 07.RA73013-51 '13-14  <b>Ultralight Steel Rear Sprocket</b> 07.RS62097R-46 07.RS62097R-47 07.RS62097R-48 07.RS62097R-49 07.RS62097R-50 07.RS62097R-51 07.RS62097R-52 '05-12  07.RS73013R-48 07.RS73013R-49 07.RS73013R-50 07.RS73013R-51 '13-14  <b>Sprocket Bolt Set</b> 07.SBSM825 '05-14	<b>Chain</b> 07.RC520120C '05-14 MX 07.RC520120CG '05-14 MX Gold 07.RC520120XC '05-14 X-Ring 07.RC520120XCG '05-14 X-Ring Gold	<b>Swingarm</b> 26.210125 '05-14  <b>Linkage</b> 26.110185 '05-14  <b>Upper</b> 26.350080 '05-14  <b>Lower</b> 26.450076 '05-14

DIRT  
APRILIA  
BETA  
BMW  
GAS GAS  
HONDA  
HUSABERG  
HUSQVARNA  
KAWASAKI  
KTM  
MOTO TM  
RIEJU  
SHERCO  
SUZUKI  
YAMAHA

STREET  
APRILIA  
CAGIVA  
HONDA  
KAWASAKI  
KTM  
SUZUKI  
YAMAHA

ATV-UTV  
CAN-AM  
GAS GAS  
HONDA  
KAWASAKI  
KTM  
POLARIS  
SUZUKI  
YAMAHA

PWC  
KAWASAKI  
POLARIS  
SEA DOO  
YAMAHA

SNOW  
ARCTIC CAT  
KAWASAKI  
LYNX  
MOTO-SKI  
POLARIS  
SKI DOO  
YAMAHA

MOPED & SCOOTER

MISC. TECH. SPECIAL





BETA

DIRT  
APRILIA  
BETA  
BMW  
GAS GAS  
HONDA  
HUSABERG  
HUSQVARNA  
KAWASAKI  
KTM  
MOTO TM  
RIEJU  
SHERCO  
SUZUKI  
YAMAHA

RR 480 ENDURO  
4-Stroke  
Please Note:  
Nikasil Piston Size  
-Std. Compression 11.9:1  
-Fuel Injection From 2016  
-Forged Piston

**Piston Kit**  
01.7425.A  
01.7425.B  
01.7425.C  
'15-23

**Size**  
99.96  
99.97  
99.98

**Ring Set**  
TBA  
TBA  
TBA  
'15-23

**CrankBearing & Seal Kit**  
23.CBS73050  
'15-23  
  
**Bearing**  
23.SX07E39  
'15-23 2x  
  
**Oilseal Set**  
42.7350  
'15-23

**Top-End**  
35.7426  
'16-19  
35.7430  
'20-23  
  
**Head & Base**  
36.7426  
'16-19  
36.7430  
'20-23

**Cam Chain**  
31.1900  
'15-23  
  
**Valve Shim Assortment**  
29.VSA1000  
'15-23  
29.VSA1000-2  
'15-23

STREET  
APRILIA  
CAGIVA  
HONDA  
KAWASAKI  
KTM  
SUZUKI  
YAMAHA

RR 498 ENDURO  
4-Stroke  
Please Note:  
Nikasil Piston Size  
-Std. Compression 12.0:1  
-Forged Piston

**Piston Kit**  
01.7512.A  
01.7512.B  
01.7512.C  
'12-14

**Size**  
99.95  
99.96  
99.97

**Ring Set**  
02.6508  
02.6508  
02.6508  
'12-14  
  
**Pin**  
04.2045  
'12-14  
  
**Clips**  
05.2012  
'12-14

**CrankBearing & Seal Kit**  
23.CBS73050  
'12-14  
  
**Bearing**  
23.SX07E39  
'12-14 2x  
  
**Oilseal Set**  
42.7350  
'12-14

**Cam Chain**  
31.1993  
'12-14  
  
**Valve Shim Assortment**  
29.VSA1000  
'12-14  
29.VSA1000-2  
'12-14

ATV-UTV  
CAN-AM  
GAS GAS  
HONDA  
KAWASAKI  
KTM  
POLARIS  
SUZUKI  
YAMAHA

RR 480 ENDURO  
4-Stroke  
Please Note:  
Nikasil Piston Size  
-Std. Compression 12.0:1  
-Forged Piston

**Piston Kit**  
01.7512.A  
01.7512.B  
01.7512.C  
'12-14

**Size**  
99.95  
99.96  
99.97

**Ring Set**  
02.6508  
02.6508  
02.6508  
'12-14  
  
**Pin**  
04.2045  
'12-14  
  
**Clips**  
05.2012  
'12-14

**CrankBearing & Seal Kit**  
23.CBS73050  
'12-14  
  
**Bearing**  
23.SX07E39  
'12-14 2x  
  
**Oilseal Set**  
42.7350  
'12-14

**Cam Chain**  
31.1993  
'12-14  
  
**Valve Shim Assortment**  
29.VSA1000  
'12-14  
29.VSA1000-2  
'12-14

PWC  
KAWASAKI  
POLARIS  
SEA DOO  
YAMAHA

RR 480 ENDURO  
4-Stroke  
Please Note:  
Nikasil Piston Size  
-Std. Compression 12.0:1  
-Forged Piston

**Piston Kit**  
01.7512.A  
01.7512.B  
01.7512.C  
'12-14

**Size**  
99.95  
99.96  
99.97

**Ring Set**  
02.6508  
02.6508  
02.6508  
'12-14  
  
**Pin**  
04.2045  
'12-14  
  
**Clips**  
05.2012  
'12-14

**CrankBearing & Seal Kit**  
23.CBS73050  
'12-14  
  
**Bearing**  
23.SX07E39  
'12-14 2x  
  
**Oilseal Set**  
42.7350  
'12-14

**Cam Chain**  
31.1993  
'12-14  
  
**Valve Shim Assortment**  
29.VSA1000  
'12-14  
29.VSA1000-2  
'12-14

SNOW  
ARCTIC CAT  
KAWASAKI  
LYNX  
MOTO-SKI  
POLARIS  
SKI DOO  
YAMAHA

MOPED & SCOOTER

MISC. TECH. SPECIAL

Footnotes: \* Bearings Only \*\* Rubbers included

DIRT  
APRILIA  
BETA  
BMW  
GAS GAS  
HONDA  
HUSABERG  
HUSQVARNA  
KAWASAKI  
KTM  
MOTO TM  
RIEJU  
SHERCO  
SUZUKI  
YAMAHA

STREET  
APRILIA  
CAGIVA  
HONDA  
KAWASAKI  
KTM  
SUZUKI  
YAMAHA

ATV-UTV  
CAN-AM  
GAS GAS  
HONDA  
KAWASAKI  
KTM  
POLARIS  
SUZUKI  
YAMAHA

PWC  
KAWASAKI  
POLARIS  
SEA DOO  
YAMAHA

SNOW  
ARCTIC CAT  
KAWASAKI  
LYNX  
MOTO-SKI  
POLARIS  
SKI DOO  
YAMAHA

MOPED & SCOOTER

MISC. TECH. SPECIAL

**Air Filter**  
52.63013  
'15-19  
52.63020  
'20-23  
  
**Main Jet**  
45.100-225  
'15 Keihin  
  
**Pilot Jet**  
46.040-085  
'15 Keihin  
  
**Oil Filter**  
54.64631  
'15-23 1-Pce.  
54.64631-50  
'15-23 50-Pcs.  
  
**Throttle Cable**  
53.112082  
'15  
53.112083  
'16-19  
53.112084  
'20-23

**Spring Kit**  
17.CS73013  
'15-17  
  
**Master Cylinder Rebuild Kit**  
16.940029  
'18-23

**Friction Set**  
16.S73013  
'15-17  
16.S73028  
'18-23

**F/W Bearing**  
23.S114002  
'15-23  
  
**R/W Bearing**  
23.S114004  
'15-23  
  
**Steering Bearing**  
24.110026  
'15-17

**Frontbrake Disc**  
37.BD16013  
'15-23  
  
**Rearbrake Disc**  
37.BD26013  
'15-23  
  
**Front Pad Set**  
37.103202  
'15-23  
37.103202BX  
'15-23 Box of 10  
  
**Rear Pad Set**  
37.201302  
'15-23  
37.201302BX  
'15-23 Box of 10

**Front Sprocket**  
07.FS62093-12  
07.FS62093-13  
07.FS62093-14  
07.FS62093-15  
'15-23  
  
**7075-T6 Alloy Rear Sprocket**  
07.RA73013-48  
07.RA73013-49  
07.RA73013-50  
07.RA73013-51  
'15-23  
  
**Ultralight Steel Rear Sprocket**  
07.RS73013R-48  
07.RS73013R-49  
07.RS73013R-50  
07.RS73013R-51  
'15-23  
  
**Sprocket Bolt Set**  
07.SBSM825  
'15-23

**Chain**  
07.RC520120C  
'15-23 MX  
07.RC520120CG  
'15-23 MX Gold  
07.RC520120XC  
'15-23 X-Ring  
07.RC520120XCG  
'15-23 X-Ring Gold

**Swingarm**  
26.210125  
'15-23  
  
**Linkage**  
26.110185  
'15-23  
  
**Upper**  
26.350080  
'15-22  
  
**Lower**  
26.450076  
'15-23

**Air Filter**  
52.63005  
'12  
52.63013  
'13-14  
  
**Main Jet**  
45.100-225  
'12-14 Keihin  
  
**Pilot Jet**  
46.040-085  
'12-14 Keihin  
  
**Oil Filter**  
54.64631  
'12-14 1-Pce.  
54.64631-50  
'12-14 50-Pcs.  
  
**Throttle Cable**  
53.112082  
'12-14

**Master Cylinder Rebuild Kit**  
16.940029  
'12-14

**Friction Set**  
16.S73013  
'12-14

**F/W Bearing**  
23.S114002  
'12-14  
  
**R/W Bearing**  
23.S114004  
'12-14  
  
**Steering Bearing**  
24.110026  
'12-14

**Frontbrake Disc**  
37.BD16013  
'13-14  
  
**Rearbrake Disc**  
37.BD26013  
'13-14  
  
**Front Pad Set**  
37.103202  
'12-14  
37.103202BX  
'12-14 Box of 10  
  
**Rear Pad Set**  
37.201302  
'12-14  
37.201302BX  
'12-14 Box of 10

**Front Sprocket**  
07.FS62093-12  
07.FS62093-13  
07.FS62093-14  
07.FS62093-15  
'12-14  
  
**7075-T6 Alloy Rear Sprocket**  
07.RA62097-46  
07.RA62097-47  
07.RA62097-48  
07.RA62097-49  
07.RA62097-50  
07.RA62097-51  
07.RA62097-52  
'12  
  
07.RA73013-48  
07.RA73013-49  
07.RA73013-50  
07.RA73013-51  
'13-14  
  
**Ultralight Steel Rear Sprocket**  
07.RS62097R-46  
07.RS62097R-47  
07.RS62097R-48  
07.RS62097R-49  
07.RS62097R-50  
07.RS62097R-51  
07.RS62097R-52  
'12  
  
07.RS73013R-48  
07.RS73013R-49  
07.RS73013R-50  
07.RS73013R-51  
'13-14  
  
**Sprocket Bolt Set**  
07.SBSM825  
'12-14

**Chain**  
07.RC520120C  
'12-14 MX  
07.RC520120CG  
'12-14 MX Gold  
07.RC520120XC  
'12-14 X-Ring  
07.RC520120XCG  
'12-14 X-Ring Gold

**Swingarm**  
26.210125  
'12-14  
  
**Linkage**  
26.110185  
'12-14  
  
**Upper**  
26.350080  
'12-14  
  
**Lower**  
26.450076  
'12-14



PISTON KITS



SIZES (mm)



PISTON PARTS



CRANKSHAFT PARTS



CONNECTING ROD PARTS



GASKETS



VALVE TRAIN PARTS I



VALVE TRAIN PARTS II



AIR & FUEL PARTS



CLUTCH PARTS



CLUTCH PLATE SETS



WHEEL & STEERING PARTS



BRAKE PARTS



DRIVE CHAIN PARTS I



DRIVE CHAIN PARTS II



SUSPENSION BEARING KITS



SUSPENSION PARTS



BETA

DIRT	RR 520 ENDURO 4-Stroke Please Note: Nikasil Piston Size -Std. Compression 12.0:1 -Forged Piston	<b>Piston Kit</b> 01.7512.A 01.7512.B 01.7512.C '10-11	<b>Size</b> 99.95 99.96 99.97	<b>Ring Set</b> 02.6508 02.6508 02.6508 '10-11	<b>CrankBearing &amp; Seal Kit</b> 23.CBS73050 '10-11		<b>Cam Chain</b> 31.1993 '10-11		<b>Valve Shim Assortment</b> 29.VSA1000 '10-11 29.VSA1000-2 '10-11
APRILIA BETA BMW GAS GAS HONDA HUSABERG HUSQVARNA KAWASAKI KTM MOTO TM RIEJU SHERCO SUZUKI YAMAHA				<b>Bearing</b> 23.SX07E39 '10-11 2x					
				<b>Pin</b> 04.2045 '10-11					
				<b>Oilseal Set</b> 42.7350 '10-11					
				<b>Clips</b> 05.2012 '10-11					

	<b>Air Filter</b> 52.63005 '10-11		<b>F/W Bearing</b> 23.S114002 '10-11	<b>Front Pad Set</b> 37.103202 '10-11 37.103202BX '10-11 Box of 10	<b>Front Sprocket</b> 07.FS62093-12 07.FS62093-13 07.FS62093-14 07.FS62093-15 '10-11	<b>Chain</b> 07.RC520120C '10-11 MX 07.RC520120CG '10-11 MX Gold 07.RC520120XC '10-11 X-Ring 07.RC520120XCG '10-11 X-Ring Gold	<b>Swingarm</b> 26.210125 '10-11		
	<b>Main Jet</b> 45.100-225 '10-11 Keihin		<b>R/W Bearing</b> 23.S114004 '11	<b>Rear Pad Set</b> 37.201302 '10-11 37.201302BX '10-11 Box of 10	<b>7075-T6 Alloy Rear Sprocket</b> 07.RA62097-46 07.RA62097-47 07.RA62097-48 07.RA62097-49 07.RA62097-50 07.RA62097-51 07.RA62097-52 '10-11		<b>Linkage</b> 26.110185 '10-11		
	<b>Pilot Jet</b> 46.040-085 '10-11 Keihin		<b>Steering Bearing</b> 24.110026 '10-11				<b>Upper</b> 26.350080 '10-11		
	<b>Oil Filter</b> 54.64631 '10-11 1-Pce. 54.64631-50 '10-11 50-Pcs.						<b>Lower</b> 26.450076 '10-11		
	<b>Throttle Cable</b> 53.112082 '11					<b>Ultralight Steel Rear Sprocket</b> 07.RS62097R-46 07.RS62097R-47 07.RS62097R-48 07.RS62097R-49 07.RS62097R-50 07.RS62097R-51 07.RS62097R-52 '10-11			
						<b>Sprocket Bolt Set</b> 07.SBSM825 '10-11			

DIRT	RR 520 ENDURO 4-Stroke Please Note: Nikasil Piston Size -Std. Compression 12.0:1 -Forged Piston	<b>Piston Kit</b> 01.6521.A 01.6521.B 01.6521.C '05-09	<b>Size</b> 94.94 94.95 94.96	<b>Ring Set</b> 02.6424 02.6424 02.6424 '05-09	<b>CrankBearing &amp; Seal Kit</b> 23.CBS64003 '05-09		<b>Cam Chain</b> 31.1993 '10-11		<b>Valve Shim Assortment</b> 29.VSA1000 '10-11 29.VSA1000-2 '10-11
APRILIA BETA BMW GAS GAS HONDA HUSABERG HUSQVARNA KAWASAKI KTM MOTO TM RIEJU SHERCO SUZUKI YAMAHA				<b>Bearing</b> 23.NJ206ECP-1 '05-09 2x					
				<b>Pin</b> 04.2050.5 '05-09					
				<b>Oilseal Set</b> 42.7350 '10-11					
				<b>Clips</b> 05.2012 '10-11					

BMW

	G 450 X 4-Stroke -Std. Compression 12.0:1 -Forged Piston -Fuel Injection	<b>Piston Kit</b> -	<b>Size</b> 98.00	<b>Ring Set</b> -					
APRILIA BETA BMW GAS GAS HONDA HUSABERG HUSQVARNA KAWASAKI KTM MOTO TM RIEJU SHERCO SUZUKI YAMAHA									

				<b>Front Pad Set</b> 37.102202 '08-12 37.102202BX '08-12 Box of 10	<b>Front Sprocket</b> 07.FS64011-13 07.FS64011-14 07.FS64011-15 '08-12	<b>Chain</b> 07.RC520120C '08-12 MX 07.RC520120CG '08-12 MX Gold 07.RC520120XC '08-12 X-Ring 07.RC520120XCG '08-12 X-Ring Gold			
				<b>Rear Pad Set</b> 37.202302 '08-12 37.202302BX '08-12 Box of 10					

Footnotes: \* Bearings Only \*\* Rubbers included



**GAS GAS**

**DIRT**  
APRILIA  
BETA  
BMW  
**GAS GAS**  
HONDA  
HUSABERG  
HUSQVARNA  
KAWASAKI  
KTM  
MOTO TM  
RIEJU  
SHERCO  
SUZUKI  
YAMAHA

**STREET**  
APRILIA  
CAGIVA  
HONDA  
KAWASAKI  
KTM  
SUZUKI  
YAMAHA

**ATV-UTV**  
CAN-AM  
GAS GAS  
HONDA  
KAWASAKI  
KTM  
POLARIS  
SUZUKI  
YAMAHA

**PWC**  
KAWASAKI  
POLARIS  
SEA DOO  
YAMAHA

**SNOW**  
ARCTIC CAT  
KAWASAKI  
LYNX  
MOTO-SKI  
POLARIS  
SKI DOO  
YAMAHA

**MOPED & SCOOTER**

**MISC. TECH. SPECIAL**

MC - E3 Electronic	Piston Kit	Size	Ring Set					
MC - E5 Electronic	Piston Kit	Size	Ring Set					
MC 50 2-Stroke Please Note: Nikasil Piston Size -KTM Engine	Piston Kit 01.6019.A 01.6019.B 01.6019.C '21-23	Size 39.46 39.47 39.48	Ring Set 02.6012 02.6012 02.6012 '21-23  Pin 04.1233 '21-23  Clips 05.1210C '21-23	CrankBearing & Seal Kit 23.CBS60013 '21-23  Bearing 23.6203T9C3 '21-23 2x  Oilseal Set 42.6013 '21-23	Con. Rod Kit 03.6011 '21-23  S/E Bearing 21.6011 '21-23  B/E Bearing 22.162212F '21-23  Crankpin 06.1635.9 '21-23	Complete 34.6012 '21-22  Top-End 35.6012 '21-23		
MC 65 2-Stroke Please Note: Nikasil Piston Size -KTM Engine	Piston Kit 01.6029.A 01.6029.B 01.6029.C 01.6029.D '21-23	Size 44.96 44.97 44.98 44.99	Ring Set 02.6022 02.6022 02.6022 02.6022 '21-23  Clips 05.1210C '21-23	CrankBearing & Seal Kit 23.CBS61009 '21-23  Bearing 23.6304JR2 '21-23  Oilseal Set 42.6029 '21-23	Con. Rod Kit 03.6029 '21-23  S/E Bearing 21.2001 '21-23  B/E Bearing 22.182415F '21-23  Crankpin 06.1854.3 '21-23	Complete 34.6019 '21-22  Top-End 35.6019 '21-23  Head & Base 36.6019 '21-23		

Footnotes: \* Bearings Only \*\* Rubbers included

			F/W Bearing 23.S111035 '23	Frontbrake Disc 37.BD16009 '23			Swingarm 26.210129 '23
			Steering Bearing 24.110047 '23	Rearbrake Disc 37.BD16009 '23			
			F/W Bearing 23.S111035 '21-23	Frontbrake Disc 37.BD16009 '21-23			Swingarm 26.210129 '21-23
			R/W Bearing 23.S117011 '21-23	Rearbrake Disc 37.BD16009 '21-23			Upper 26.450070 '21-23
			Steering Bearing 24.110047 '21-23	Front Pad Set 37.106302 '21-23 37.106302BX '21-23 Box of 10			Lower 26.450070 '21-23
Air Filter 52.60009 '21-23	Cover Gasket 19.G6012 '21-23 Outer		F/W Bearing 23.S111035 '21-23	Frontbrake Disc 37.BD16009 '21-23	Front Sprocket 07.FS60009-10 07.FS60009-11 '21-23		Swingarm 26.210129 '21-23
Throttle Cable 53.112088 '21-23			R/W Bearing 23.S117011 '21-23	Rearbrake Disc 37.BD16009 '21-23			Upper 26.450070 '21-23
Water Pump Rebuild Kit 57.6022 '21-23			Steering Bearing 24.110047 '21-23	Front Pad Set 37.106302 '21-23 37.106302BX '21-23 Box of 10			Lower 26.450070 '21-23
Air Filter 52.61097 '21-23	Basket 17.6020F '21-23	Friction Set 16.S50012 '21-23	F/W Bearing 23.S111035 '21-23	Frontbrake Disc 37.BD16000 '21-23	Front Sprocket 07.FS60004-12 07.FS60004-13 07.FS60004-14 07.FS60004-15 '21-23	Chain 07.RC420130C '21-23 MX	Swingarm 26.210129 '21-23
Main Jet 47.090-580 '21-23 Mikuni	Master Cylinder Rebuild Kit 16.910055 '21	Steel Set 16.S50013 '21-23	R/W Bearing 23.S113045 '21-23	Rearbrake Disc 37.BD26000 '21-23		Countershaft Seal Kit 26.640006 '21-23	Upper 26.450070 '21-23
Pilot Jet 48.015-080 '21-23 Mikuni	Slave Cylinder Rebuild Kit 16.950013 '21		Steering Bearing 24.110047 '21-23	Front Pad Set 37.109202 '21-22 37.202302 '23 37.109202BX '21-22 Box of 10 37.202302BX '23 Box of 10		7075-T6 Alloy Rear Sprocket 07.RA60097-44 07.RA60097-45 07.RA60097-46 07.RA60097-47 07.RA60097-48 07.RA60097-49 07.RA60097-50 '21-23	Lower 26.450070 '21-23
Carburetor Rebuild Kit 55.10519 '21-22				Rear Pad Set 37.109202 '21-22 37.202302 '23 37.109202BX '21-22 Box of 10 37.202302BX '23 Box of 10	Sprocket Bolt Set 07.SBSM825 '21-23		
Throttle Cable 53.112089 '21-23				Front Master Cylinder Rebuild Kit 16.910055 '21-22			
Water Pump Rebuild Kit 57.6029 '21-23							

**DIRT**  
APRILIA  
BETA  
BMW  
**GAS GAS**  
HONDA  
HUSABERG  
HUSQVARNA  
KAWASAKI  
KTM  
MOTO TM  
RIEJU  
SHERCO  
SUZUKI  
YAMAHA

**STREET**  
APRILIA  
CAGIVA  
HONDA  
KAWASAKI  
KTM  
SUZUKI  
YAMAHA

**ATV-UTV**  
CAN-AM  
GAS GAS  
HONDA  
KAWASAKI  
KTM  
POLARIS  
SUZUKI  
YAMAHA

**PWC**  
KAWASAKI  
POLARIS  
SEA DOO  
YAMAHA

**SNOW**  
ARCTIC CAT  
KAWASAKI  
LYNX  
MOTO-SKI  
POLARIS  
SKI DOO  
YAMAHA

**MOPED & SCOOTER**

**MISC. TECH. SPECIAL**





**GAS GAS**

DIRT	MC 85	Piston Kit	Size	Ring Set	CrankBearing & Seal Kit	Con. Rod Kit	Top-End		
APRILIA BETA BMW	2-Stroke Please Note: Nikasil Piston Size -KTM Engine	01.6105.A 01.6105.B 01.6105.C 01.6105.D '21-23	46.95 46.96 46.97 46.98	02.6105 02.6105 02.6105 02.6105 '21-23	23.CBS61003 '21-23	03.6113 '21-23	35.6118 '21-23		
GAS GAS HONDA HUSABERG HUSQVARNA KAWASAKI KTM MOTO TM RIEJU SHERCO SUZUKI YAMAHA				Clips 05.1410C '21-23	Bearing 23.NJ205 '21-23 Left 23.6304/22 '21-23 Right	S/E Bearing 21.1111 '21-23	Head & Base 36.6118 '21-23		
					Oilseal Set 42.6103 '21-23	B/E Bearing 22.202615F '21-23			
						Crankpin 06.2045.9 '21-23			

Air Filter	Master Cylinder Rebuild Kit	Complete Plate Set	F/W Bearing	Frontbrake Disc	Front Sprocket	Chain	Swingarm
52.61018 '21-23	16.910055 '21-23	16.CPS61018 '21-23	23.S114006 '21-23	37.BD16112 '21-23	07.FS61018-12 07.FS61018-13 07.FS61018-14 07.FS61018-15 '21-23	07.RC428130C '21-23 MX	26.210087 '21-23
Main Jet 45.100-225 '21-23 Keihin	Slave Cylinder Rebuild Kit 16.950013 '21-23	Friction Set 16.S51018 '21-23	R/W Bearing 23.S112073 '21-23	Rearbrake Disc 37.BD26190 '21-23		Countershaft Seal Kit 26.640005 '21-23	Upper 26.350059 '21-23
Pilot Jet 46.040-085 '21-23 Keihin		Steel Set 16.S51019 '21-23	F/W Spacer Kit 26.710105 '21-23	Front Pad Set 37.102202 '21-23	7075-T6 Alloy Rear Sprocket 07.RA61003-46 07.RA61003-47 07.RA61003-48 07.RA61003-49 07.RA61003-50 07.RA61003-51 '21-23		Lower 26.350059 '21-23
Carburetor Rebuild Kit 55.10518 '21-22			R/W Spacer Kit 26.710084 '21-23	37.102202BX '21-23 Box of 10			
			Steering Bearing 24.110047 '21-23	Rear Pad Set 37.202302 '21-23			
				37.202302BX '21-23 Box of 10			
				Front Master Cylinder Rebuild Kit 16.910055 '21-23			
					UltraLight Steel Rear Sprocket 07.RS61003R-46 07.RS61003R-47 07.RS61003R-48 07.RS61003R-49 07.RS61003R-50 07.RS61003R-51 '21-23		
					Sprocket Bolt Set 07.SBSM825 '21-23		

DIRT	APRILIA BETA BMW	GAS GAS HONDA HUSABERG HUSQVARNA KAWASAKI KTM MOTO TM RIEJU SHERCO SUZUKI YAMAHA
STREET	APRILIA CAGIVA HONDA KAWASAKI KTM SUZUKI YAMAHA	APRILIA CAGIVA HONDA KAWASAKI KTM SUZUKI YAMAHA
ATV-UTV	CAN-AM GAS GAS HONDA KAWASAKI KTM POLARIS SUZUKI YAMAHA	CAN-AM GAS GAS HONDA KAWASAKI KTM POLARIS SUZUKI YAMAHA
PWC	KAWASAKI POLARIS SEA DOO YAMAHA	KAWASAKI POLARIS SEA DOO YAMAHA
SNOW	ARCTIC CAT KAWASAKI LYNX MOTO-SKI POLARIS SKI DOO YAMAHA	ARCTIC CAT KAWASAKI LYNX MOTO-SKI POLARIS SKI DOO YAMAHA
MOPED & SCOOTER		
MISC. TECH. SPECIAL		

Footnotes: \* Bearings Only \*\* Rubbers included



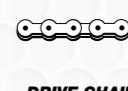

**GAS GAS**

**DIRT**  
APRILIA  
BETA  
BMW  
GAS GAS  
HONDA  
HUSABERG  
HUSQVARNA  
KAWASAKI  
KTM  
MOTO TM  
RIEJU  
SHERCO  
SUZUKI  
YAMAHA

MC 125 2-Stroke Please Note: Nikasil Piston Size -KTM Engine	Piston Kit 01.6226.A 01.6226.B 01.6226.C 01.6226.D 01.6226.E '21-23	Size 53.94 53.95 53.96 53.97 53.98	Ring Set 02.6225 02.6225 02.6225 02.6225 02.6225 '21-23	CrankBearing & Seal Kit 23.CBS62001 '21-23	Con. Rod Kit 03.6226 '21-23	Top-End 35.6216 '21-23			
			Pin 04.1545 '21-23	Bearing 23.NJ206 '21-23 Left 23.6305JR2 '21-23 Right	S/E Bearing 21.3206 '21-23	Head & Base 36.6216 '21-23			
			Clips 05.1510 '21-23	Oilseal Set 42.6218 '21-23	B/E Bearing 22.222816F '21-23				
				Crankpin 06.2255.9 '21-23					

**STREET**  
APRILIA  
CAGIVA  
HONDA  
KAWASAKI  
KTM  
SUZUKI  
YAMAHA

**ATV-UTV**  
CAN-AM  
GAS GAS  
HONDA  
KAWASAKI  
KTM  
POLARIS  
SUZUKI  
YAMAHA

**PWC**  
KAWASAKI  
POLARIS  
SEA DOO  
YAMAHA

**SNOW**  
ARCTIC CAT  
KAWASAKI  
LYNX  
MOTO-SKI  
POLARIS  
SKI DOO  
YAMAHA

**MOPED & SCOOTER**

**MISC. TECH. SPECIAL**

**DIRT**  
APRILIA  
BETA  
BMW  
GAS GAS  
HONDA  
HUSABERG  
HUSQVARNA  
KAWASAKI  
KTM  
MOTO TM  
RIEJU  
SHERCO  
SUZUKI  
YAMAHA

**STREET**  
APRILIA  
CAGIVA  
HONDA  
KAWASAKI  
KTM  
SUZUKI  
YAMAHA

**ATV-UTV**  
CAN-AM  
GAS GAS  
HONDA  
KAWASAKI  
KTM  
POLARIS  
SUZUKI  
YAMAHA

**PWC**  
KAWASAKI  
POLARIS  
SEA DOO  
YAMAHA

**SNOW**  
ARCTIC CAT  
KAWASAKI  
LYNX  
MOTO-SKI  
POLARIS  
SKI DOO  
YAMAHA

**MOPED & SCOOTER**

**MISC. TECH. SPECIAL**

Air Filter 52.62016 '21-23	Cover Gasket 19.G6216 '21-23	Complete Plate Set 16.CPS63029 '21-23	F/W Bearing 23.S114002 '21-23	Frontbrake Disc 37.BD16290 '21-23	Front Sprocket 07.FS62093-12 07.FS62093-13 07.FS62093-14 07.FS62093-15 '21-23	Chain 07.RC520120C '21-23 MX 07.RC520120CG '21-23 MX Gold 07.RC520120XC '21-23 X-Ring 07.RC520120XCG '21-23 X-Ring Gold	Swingarm 26.210125 '21-23
Main Jet 47.090-580 '21-23 Mikuni	Master Cylinder Rebuild Kit 16.940010 '21-23	Friction Set 16.S53009 '21-23	R/W Bearing 23.S112073 '21-23	Rearbrake Disc 37.BD26190 '21-23	7075-T6 Alloy Rear Sprocket 07.RA62090-48 07.RA62090-49 07.RA62090-50 07.RA62090-51 07.RA62090-52 '21-23	Countershaft Seal Kit 26.640045 '21-23	Upper 26.450068 '21-23
Pilot Jet 49.010-045 '21-23 Mikuni	Slave Cylinder Rebuild Kit 16.950014 '21-23	Steel/Alloy 16.S53010 '21-23	F/W Spacer Kit 26.710103 '21-23	Front Pad Set 37.102202 '21-23	7075-T6 Alloy Rear Sprocket 07.RA62090-48 07.RA62090-49 07.RA62090-50 07.RA62090-51 07.RA62090-52 '21-23		
Throttle Cable 53.112087 '21-23			R/W Spacer Kit 26.710102 '21-23	Front Pad Set 37.102202BX '21-23 Box of 10	7075-T6 Alloy Rear Sprocket 07.RA62090-48 07.RA62090-49 07.RA62090-50 07.RA62090-51 07.RA62090-52 '21-23		
			Steering Bearing 24.110026 '21-23	Rear Pad Set 37.202302 '21-23	Ultralight Steel Rear Sprocket 07.RS62090R-48 07.RS62090R-49 07.RS62090R-50 07.RS62090R-51 07.RS62090R-52 '21-23		
				Front Caliper Rebuild Kit 37.63046 '21-23	Sprocket Bolt Set 07.SBSM825 '21-23		
				Rear Caliper Rebuild Kit 37.63048 '21-23			
				Front Master Cylinder Rebuild Kit 37.910035 '21-23			
				Rear Master Cylinder Rebuild Kit 37.910030 '21-23			

Air Filter 52.72092 '92-06 52.73007 '07-17 52.73018 '18-19	Spring Kit 17.CS13005 '97-17	Master Cylinder Rebuild Kit 16.940003 '12-19	F/W Bearing 23.S110070 '96-03 23.S113064 '04-19	Frontbrake Disc 37.BD17095 '95-17	Front Sprocket 07.FS73000-12 07.FS73000-13 '00-19	Chain 07.RC520120C '01-19 MX 07.RC520120CG '01-19 MX Gold 07.RC520120XC '01-19 X-Ring 07.RC520120XCG '01-19 X-Ring Gold	Swingarm 26.210116 '96-13
Main Jet 45.100-225 '00-19 Keihin			R/W Bearing 23.S114057 '96-02 23.S114058 '03-17	Rearbrake Disc 37.BD27095 '95-17	7075-T6 Alloy Rear Sprocket 07.RA62097-46 07.RA62097-47 07.RA62097-48 07.RA62097-49 07.RA62097-50 07.RA62097-51 07.RA62097-52 '01-19	Linkage 26.110118 '96-11	Lower 26.450046 '96-11
Pilot Jet 46.040-085 '00-19 Keihin			Steering Bearing 24.110044 '96-05 24.110056 '06-19	Front Pad Set 37.103202 '01-19 37.103202BX '01-19 Box of 10	7075-T6 Alloy Rear Sprocket 07.RA62097-46 07.RA62097-47 07.RA62097-48 07.RA62097-49 07.RA62097-50 07.RA62097-51 07.RA62097-52 '01-19	Lower Chain Roller 33.0008 '97-12	Upper Chain Roller 33.0001 '97-12
				Rear Pad Set 37.207102 '01-08 37.207102BX '01-08 Box of 10 37.201302 '09-19 37.201302BX '09-19 Box of 10	Sprocket Bolt Set 07.SBSM825 '01-19		

Footnotes: \* Bearings Only \*\* Rubbers included





**GAS GAS**

**DIRT**  
 APRILIA  
 BETA  
 BMW  
 GAS GAS  
 HONDA  
 HUSABERG  
 HUSQVARNA  
 KAWASAKI  
 KTM  
 MOTO TM  
 RIEJU  
 SHERCO  
 SUZUKI  
 YAMAHA

MC 250 2-Stroke Please Note: Nikasil Piston Size -KTM Engine -Molycoated Skirt	<b>Piston Kit</b> 01.6343.A 01.6343.B 01.6343.C 01.6343.D '22-23	<b>Size</b> 66.34 66.35 66.36 66.37	<b>Ring Set</b> 02.6324 02.6324 02.6324 02.6324 '22-23	<b>CrankBearing &amp; Seal Kit</b> 23.CBS63004 '22-23	<b>Con. Rod Kit</b> 03.6323 '22-23	<b>Top-End</b> 34.6317 '22											
			<b>Pin</b> 04.1856 '22-23	<b>Bearing</b> 23.NJ207ECS '22-23 Left 23.6232X2 '22-23 Right	<b>S/E Bearing</b> 21.6320 '22-23	<b>Top-End</b> 35.6320 '22-23											
			<b>Clips</b> 05.1812 '22-23	<b>Oilseal Set</b> 42.6320 '22-23	<b>B/E Bearing</b> 22.243017F '22-23	<b>Head &amp; Base</b> 36.6317 '22-23											
					<b>Crankpin</b> 06.2459.6 '22-23												

**STREET**  
 APRILIA  
 CAGIVA  
 HONDA  
 KAWASAKI  
 KTM  
 SUZUKI  
 YAMAHA

**ATV-UTV**  
 CAN-AM  
 GAS GAS  
 HONDA  
 KAWASAKI  
 KTM  
 POLARIS  
 SUZUKI  
 YAMAHA

**PWC**  
 KAWASAKI  
 POLARIS  
 SEA DOO  
 YAMAHA

**SNOW**  
 ARCTIC CAT  
 KAWASAKI  
 LYNX  
 MOTO-SKI  
 POLARIS  
 SKI DOO  
 YAMAHA

**MOPED & SCOOTER**

**MISC. TECH. SPECIAL**

Footnotes: \* Bearings Only \*\* Rubbers included

**DIRT**  
 APRILIA  
 BETA  
 BMW  
 GAS GAS  
 HONDA  
 HUSABERG  
 HUSQVARNA  
 KAWASAKI  
 KTM  
 MOTO TM  
 RIEJU  
 SHERCO  
 SUZUKI  
 YAMAHA

<b>Air Filter</b> 52.62016 '22-23	<b>Cover Gasket</b> 19.G6317 '22-23	<b>Complete Plate Set</b> 16.CPS64012 '22-23	<b>F/W Bearing</b> 23.S114002 '22-23	<b>Frontbrake Disc</b> 37.BD16290 '22-23	<b>Front Sprocket</b> 07.FS62093-12 07.FS62093-13 07.FS62093-14 07.FS62093-15 '22-23	<b>Chain</b> 07.RC520120C '22-23 MX 07.RC520120CG '22-23 MX Gold 07.RC520120XC '22-23 X-Ring 07.RC520120XCG '22-23 X-Ring Gold	<b>Swingarm</b> 26.210125 '22-23												
<b>Main Jet</b> 47.090-580 '22-23 Mikuni		<b>Friction Set</b> 16.S53011 '22-23	<b>R/W Bearing</b> 23.S112073 '22-23	<b>Rearbrake Disc</b> 37.BD26190 '22-23			<b>Upper</b> 26.450068 '22-23												
<b>Pilot Jet</b> 49.010-045 '22-23 Mikuni		<b>Steel Set</b> 16.S53029 '22-23	<b>F/W Spacer Kit</b> 26.710103 '22-23	<b>Front Pad Set</b> 37.102202 '22-23		<b>7075-T6 Alloy Rear Sprocket</b> 07.RA62090-48 07.RA62090-49 07.RA62090-50 07.RA62090-51 07.RA62090-52 '22-23	<b>Countershaft Seal Kit</b> 26.640001 '22-23												
<b>Throttle Cable</b> 53.112087 '22-23			<b>R/W Spacer Kit</b> 26.710102 '22-23	<b>Front Caliper Rebuild Kit</b> 37.63046 '22-23		<b>UltraLight Steel Rear Sprocket</b> 07.RS62090R-48 07.RS62090R-49 07.RS62090R-50 07.RS62090R-51 07.RS62090R-52 '22-23													
			<b>Steering Bearing</b> 24.110026 '22-23	<b>Rear Caliper Rebuild Kit</b> 37.63048 '22-23		<b>Sprocket Bolt Set</b> 07.SBSM825 '22-23													
				<b>Front Master Cylinder Rebuild Kit</b> 37.910035 '22-23															
				<b>Rear Master Cylinder Rebuild Kit</b> 37.910030 '22-23															

**STREET**  
 APRILIA  
 CAGIVA  
 HONDA  
 KAWASAKI  
 KTM  
 SUZUKI  
 YAMAHA

**ATV-UTV**  
 CAN-AM  
 GAS GAS  
 HONDA  
 KAWASAKI  
 KTM  
 POLARIS  
 SUZUKI  
 YAMAHA

**PWC**  
 KAWASAKI  
 POLARIS  
 SEA DOO  
 YAMAHA

**SNOW**  
 ARCTIC CAT  
 KAWASAKI  
 LYNX  
 MOTO-SKI  
 POLARIS  
 SKI DOO  
 YAMAHA

**MOPED & SCOOTER**

**MISC. TECH. SPECIAL**



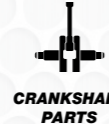

**GAS GAS**

DIRT	EX 250 2-Stroke Please Note: Nikasil Piston Size -KTM Engine -Fuel Injection -Molycoated Skirt	Piston Kit 01.6343.A 01.6343.B 01.6343.C 01.6343.D '22-23	Size 66.34 66.35 66.36 66.37	Ring Set 02.6324 02.6324 02.6324 02.6324 '22-23	CrankBearing & Seal Kit 23.CBS63004 '22-23	Con. Rod Kit 03.6323 '22-23	Complete 34.6317 '22		
	APRILIA BETA BMW GAS GAS HONDA HUSABERG HUSQVARNA KAWASAKI KTM MOTO TM RIEJU SHERCO SUZUKI YAMAHA	Bearing 23.NJ207ECS '22-23 Left 23.6232X2 '22-23 Right	Pin 04.1856 '22-23	Clips 05.1812 '22-23	Oilseal Set 42.6320 '22-23	S/E Bearing 21.6320 '22-23	B/E Bearing 22.243017F '22-23	Top-End 35.6320 '22-23	Head & Base 36.6317 '22-23
STREET									
	APRILIA CAGIVA HONDA KAWASAKI KTM SUZUKI YAMAHA								
ATV-UTV	EC 250 F 4-Stroke Please Note: Nikasil Piston Size -Std. Compression 12.5:1 -Forged Piston -Yamaha Engine	Piston Kit 01.2406.A 01.2406.B 01.2406.C '10-15	Size 76.95 76.96 76.97	Ring Set 02.2402 02.2402 02.2402 '10-15	CrankBearing & Seal Kit 23.CBS24001* '10-15	Con. Rod Kit 03.2403 '10-15	Head & Base 36.2301 '10-15	Cam Chain 31.2402 '10-15	Valve 28.2401-1 '10-15 2x Exhaust Titanium 28.2401-2 '10-15 1x Intake I Titanium 28.2401-3 '10-15 2x Intake II Titanium
	KAWASAKI POLARIS SEA DOO YAMAHA	Bearing 23.830046-1 '10-15 2x	Pin 04.1644.4 '10-15	Clips 05.1610 '10-15	B/E Bearing 22.324018F '10-15	Crackpin 06.3254.8 '10-15	Valve Shim Assortment 29.VSA748 '10-15 29.VSA748-2 '10-15	Ti-Steel Conversion Set 28.SES2402-1 '10-15 Exhaust 28.SIS2402-2 '10-15 Intake	Valve Seal 35.VS011 '10-15 3x Intake 35.VS012 '10-15 2x Exhaust
SNOW									
	ARCTIC CAT KAWASAKI LYNX MOTO-SKI POLARIS SKI DOO YAMAHA								
MOPED & SCOOTER									
MISC. TECH. SPECIAL									

Footnotes: \* Bearings Only \*\* Rubbers included

Air Filter 52.62016 '22-23	Cover Gasket 19.G6317 '22-23	Complete Plate Set 16.CPS64012 '22-23	F/W Bearing 23.S114002 '22-23	Frontbrake Disc 37.BD16290 '22-23	Front Sprocket 07.FS62093-12 07.FS62093-13 07.FS62093-14 07.FS62093-15 '22-23	Chain 07.RC520120C '22-23 MX 07.RC520120CG '22-23 MX Gold 07.RC520120XC '22-23 X-Ring 07.RC520120XCG '22-23 X-Ring Gold	Swingarm 26.210125 '22-23		
Throttle Cable 53.112072 '22 53.112091 '23		Friction Set 16.S53011 '22-23	R/W Bearing 23.S112073 '22-23	Rearbrake Disc 37.BD26190 '22-23	7075-T6 Alloy Rear Sprocket 07.RA62090-48 07.RA62090-49 07.RA62090-50 07.RA62090-51 07.RA62090-52 '22-23	Countershaft Seal Kit 26.640001 '22-23	Linkage 26.110180 '22-23	Lower 26.450066 '22-23	Upper 26.450068 '22-23
		Steel Set 16.S53029 '22-23	F/W Spacer Kit 26.710103 '22-23	Front Pad Set 37.102202 '22-23 37.102202BX '22-23 Box of 10	7075-T6 Alloy Rear Sprocket 07.RS62090R-48 07.RS62090R-49 07.RS62090R-50 07.RS62090R-51 07.RS62090R-52 '22-23	Countershaft Seal Kit 26.640001 '22-23			
			R/W Spacer Kit 26.710084 '22-23	Rear Pad Set 37.202302 '22-23	UltraLight Steel Rear Sprocket 07.RS62090R-48 07.RS62090R-49 07.RS62090R-50 07.RS62090R-51 07.RS62090R-52 '22-23	Sprocket Bolt Set 07.SBSM825 '22-23			
			Steering Bearing 24.110026 '22-23	Front Caliper Rebuild Kit 37.63046 '22-23	UltraLight Steel Rear Sprocket 07.RS62090R-48 07.RS62090R-49 07.RS62090R-50 07.RS62090R-51 07.RS62090R-52 '22-23	Sprocket Bolt Set 07.SBSM825 '22-23			
				Rear Caliper Rebuild Kit 37.63048 '22-23	Front Master Cylinder Rebuild Kit 37.910035 '22-23				
				Front Master Cylinder Rebuild Kit 37.910030 '22-23	Rear Master Cylinder Rebuild Kit 37.910030 '22-23				
PWC									
	KAWASAKI POLARIS SEA DOO YAMAHA								
SNOW									
	ARCTIC CAT KAWASAKI LYNX MOTO-SKI POLARIS SKI DOO YAMAHA								
MOPED & SCOOTER									
MISC. TECH. SPECIAL									

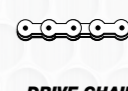

**GAS GAS**

**DIRT**  
APRILIA  
BETA  
BMW  
**GAS GAS**  
HONDA  
HUSABERG  
HUSQVARNA  
KAWASAKI  
KTM  
MOTO TM  
RIEJU  
SHERCO  
SUZUKI  
YAMAHA

MC 250 F 4-Stroke Please Note: Nikasil Piston Size -KTM Engine -Fuel Injection -Forged Piston -Std. Compression 14.4:1	<b>Piston Kit</b> 01.6347.A 01.6347.B 01.6347.C '21-23	<b>Size</b> 77.96 77.97 77.98	<b>Ring Set</b> 02.6347 02.6347 02.6347 '21-23	<b>CrankBearing &amp; Seal Kit</b> 23.CBS63017 '21-23	<b>Con. Rod Kit</b> 03.6337 '21-23	<b>Complete</b> 34.6316 '21-22	<b>Cam Chain</b> 31.6356 '21-23	<b>Valve</b> 28.6333-1 '21-23 Exhaust Titanium 28.6333-2 '21-23 Intake Titanium
			<b>Pin</b> 04.1639.9 '21-23	<b>Bearing</b> 23.NJ206ECP-3 '21-23 2x	<b>Crankpin</b> 06.3056-2 '21-23	<b>Top-End</b> 35.6316 '21-23	<b>Valve Shim Assortment</b> 29.VSA890 '21-23	<b>Valve Seal</b> 35.VS028 '21-23 4x
			<b>Clips</b> 05.1612C '21-23	<b>Oilseal</b> 41.6-405561 '21-23		<b>Head &amp; Base</b> 36.6316 '21-23		
						<b>Ignition Cover Gasket</b> 19.G96316 '21-23		

**STREET**  
APRILIA  
CAGIVA  
HONDA  
KAWASAKI  
KTM  
SUZUKI  
YAMAHA

**ATV-UTV**  
CAN-AM  
GAS GAS  
HONDA  
KAWASAKI  
KTM  
POLARIS  
SUZUKI  
YAMAHA

**PWC**  
KAWASAKI  
POLARIS  
SEA DOO  
YAMAHA

**SNOW**  
ARCTIC CAT  
KAWASAKI  
LYNX  
MOTO-SKI  
POLARIS  
SKI DOO  
YAMAHA

**MOPED & SCOOTER**

**MISC. TECH. SPECIAL**

Footnotes: \* Bearings Only \*\* Rubbers included

<b>Air Filter</b> 52.62016 '21-23	<b>Cover Gasket</b> 19.G6316 '21-23	<b>Complete Plate Set</b> 16.CPS63019 '21-23	<b>F/W Bearing</b> 23.S114002 '21-23	<b>Frontbrake Disc</b> 37.BD16290 '21-23	<b>Front Sprocket</b> 07.FS62093-12 07.FS62093-13 07.FS62093-14 07.FS62093-15 '21-23	<b>Chain</b> 07.RC520120C '21-23 MX 07.RC520120CG '21-23 MX Gold 07.RC520120XC '21-23 X-Ring 07.RC520120XCG '21-23 X-Ring Gold	<b>Swingarm</b> 26.210125 '21-23
<b>Throttle Cable</b> 53.112073 '21-23	<b>Master Cylinder Rebuild Kit</b> 16.940010 '21	<b>Friction Set</b> 16.S53016 '21-23	<b>R/W Bearing</b> 23.S112073 '21-23	<b>Rearbrake Disc</b> 37.BD26190 '21-23		<b>Upper</b> 26.450068 '21-23	
<b>Oil Filter</b> 54.63652 '21-23 1-Pce. 54.63652-50 '21-23 50-Pcs.	<b>Slave Cylinder Rebuild Kit</b> 16.950014 '21	<b>Steel Set</b> 16.S53027 '21-23	<b>F/W Spacer Kit</b> 26.710103 '21-23	<b>Front Pad Set</b> 37.102202 '21-23	<b>7075-T6 Alloy Rear Sprocket</b> 07.RA62090-48 07.RA62090-49 07.RA62090-50 07.RA62090-51 07.RA62090-52 '21-23	<b>Countershaft Seal Kit</b> 26.640001 '21-23	
			<b>R/W Spacer Kit</b> 26.710102 '21-23	<b>Rear Pad Set</b> 37.202302 '21-23	<b>Ultralight Steel Rear Sprocket</b> 07.RS62090R-48 07.RS62090R-49 07.RS62090R-50 07.RS62090R-51 07.RS62090R-52 '21-23		
			<b>Steering Bearing</b> 24.110026 '21-23	<b>Front Caliper Rebuild Kit</b> 37.63046 '21-23	<b>Sprocket Bolt Set</b> 07.SBSM825 '21-23		
				<b>Rear Caliper Rebuild Kit</b> 37.63048 '21-23			
				<b>Front Master Cylinder Rebuild Kit</b> 37.910035 '21-23			
				<b>Rear Master Cylinder Rebuild Kit</b> 37.910030 '21-23			

**DIRT**  
APRILIA  
BETA  
BMW  
**GAS GAS**  
HONDA  
HUSABERG  
HUSQVARNA  
KAWASAKI  
KTM  
MOTO TM  
RIEJU  
SHERCO  
SUZUKI  
YAMAHA

**STREET**  
APRILIA  
CAGIVA  
HONDA  
KAWASAKI  
KTM  
SUZUKI  
YAMAHA

**ATV-UTV**  
CAN-AM  
GAS GAS  
HONDA  
KAWASAKI  
KTM  
POLARIS  
SUZUKI  
YAMAHA

**PWC**  
KAWASAKI  
POLARIS  
SEA DOO  
YAMAHA

**SNOW**  
ARCTIC CAT  
KAWASAKI  
LYNX  
MOTO-SKI  
POLARIS  
SKI DOO  
YAMAHA

**MOPED & SCOOTER**

**MISC. TECH. SPECIAL**

Footnotes: \* Bearings Only \*\* Rubbers included



**GAS GAS**

**DIRT**  
APRILIA  
BETA  
BMW  
GAS GAS  
HONDA  
HUSABERG  
HUSQVARNA  
KAWASAKI  
KTM  
MOTO TM  
RIEJU  
SHERCO  
SUZUKI  
YAMAHA

EX 250 F  
4-Stroke  
Please Note:  
Nikasil Piston Size  
-KTM Engine  
-Fuel Injection  
-Std. Compression 14.4:1

<b>Piston Kit</b> 01.6347.A 01.6347.B 01.6347.C '21-23	<b>Size</b> 77.96 77.97 77.98	<b>Ring Set</b> 02.6347 02.6347 02.6347 '21-23	<b>CrankBearing &amp; Seal Kit</b> 23.CBS63017 '21-23	<b>Con. Rod Kit</b> 03.6337 '21-23	<b>Complete</b> 34.6316 '21-22	<b>Cam Chain</b> 31.6356 '21-23	<b>Valve</b> 28.6333-1 '21-23 Exhaust Titanium 28.6333-2 '21-23 Intake Titanium
		<b>Pin</b> 04.1639.9 '21-23	<b>Bearing</b> 23.NJ206EPC-3 '21-23 2x	<b>Crankpin</b> 06.3056-2 '21-23	<b>Top-End</b> 35.6316 '21-23	<b>Valve Shim Assortment</b> 29.VSA890 '21-23	<b>Valve Seal</b> 35.VS028 '21-23 4x
		<b>Clips</b> 05.1612C '21-23	<b>Oilseal</b> 41.6-405561 '21-23		<b>Head &amp; Base</b> 36.6316 '21-23		
					<b>Ignition Cover Gasket</b> 19.G96316 '21-23		

**STREET**  
APRILIA  
CAGIVA  
HONDA  
KAWASAKI  
KTM  
SUZUKI  
YAMAHA

EC / XC 300  
2-Stroke  
Please Note:  
Nikasil Piston Size  
-Forged Piston  
-GasGas Engine

<b>Piston Kit</b> 01.7300.A 01.7300.B 01.7300.C '00-19	<b>Size</b> 71.94 71.95 71.96	<b>Ring Set</b> 02.6396 02.6396 02.6396 '00-19		<b>Con. Rod Kit</b> 03.1315 '00-19			
		<b>Pin</b> 04.1853.4 '00-19		<b>S/E Bearing</b> 21.1303 '00-19			
		<b>Clips</b> 05.1812 '00-19					

**ATV-UTV**  
CAN-AM  
GAS GAS  
HONDA  
KAWASAKI  
KTM  
POLARIS  
SUZUKI  
YAMAHA

EC / XC 300  
2-Stroke  
Please Note:  
Nikasil Piston Size  
-Forged Piston  
-GasGas Engine

<b>Piston Kit</b> 01.7300.A 01.7300.B 01.7300.C '00-19	<b>Size</b> 71.94 71.95 71.96	<b>Ring Set</b> 02.6396 02.6396 02.6396 '00-19		<b>Con. Rod Kit</b> 03.1315 '00-19			
		<b>Pin</b> 04.1853.4 '00-19		<b>S/E Bearing</b> 21.1303 '00-19			
		<b>Clips</b> 05.1812 '00-19					

**PWC**  
KAWASAKI  
POLARIS  
SEA DOO  
YAMAHA

EC / XC 300  
2-Stroke  
Please Note:  
Nikasil Piston Size  
-Forged Piston  
-GasGas Engine

<b>Piston Kit</b> 01.7300.A 01.7300.B 01.7300.C '00-19	<b>Size</b> 71.94 71.95 71.96	<b>Ring Set</b> 02.6396 02.6396 02.6396 '00-19		<b>Con. Rod Kit</b> 03.1315 '00-19			
		<b>Pin</b> 04.1853.4 '00-19		<b>S/E Bearing</b> 21.1303 '00-19			
		<b>Clips</b> 05.1812 '00-19					

**SNOW**  
ARCTIC CAT  
KAWASAKI  
LYNX  
MOTO-SKI  
POLARIS  
SKI DOO  
YAMAHA

EC / XC 300  
2-Stroke  
Please Note:  
Nikasil Piston Size  
-Forged Piston  
-GasGas Engine

<b>Piston Kit</b> 01.7300.A 01.7300.B 01.7300.C '00-19	<b>Size</b> 71.94 71.95 71.96	<b>Ring Set</b> 02.6396 02.6396 02.6396 '00-19		<b>Con. Rod Kit</b> 03.1315 '00-19			
		<b>Pin</b> 04.1853.4 '00-19		<b>S/E Bearing</b> 21.1303 '00-19			
		<b>Clips</b> 05.1812 '00-19					

**MOPED & SCOOTER**

EC / XC 300  
2-Stroke  
Please Note:  
Nikasil Piston Size  
-Forged Piston  
-GasGas Engine

<b>Piston Kit</b> 01.7300.A 01.7300.B 01.7300.C '00-19	<b>Size</b> 71.94 71.95 71.96	<b>Ring Set</b> 02.6396 02.6396 02.6396 '00-19		<b>Con. Rod Kit</b> 03.1315 '00-19			
		<b>Pin</b> 04.1853.4 '00-19		<b>S/E Bearing</b> 21.1303 '00-19			
		<b>Clips</b> 05.1812 '00-19					

**MISC. TECH. SPECIAL**

EC / XC 300  
2-Stroke  
Please Note:  
Nikasil Piston Size  
-Forged Piston  
-GasGas Engine

<b>Piston Kit</b> 01.7300.A 01.7300.B 01.7300.C '00-19	<b>Size</b> 71.94 71.95 71.96	<b>Ring Set</b> 02.6396 02.6396 02.6396 '00-19		<b>Con. Rod Kit</b> 03.1315 '00-19			
		<b>Pin</b> 04.1853.4 '00-19		<b>S/E Bearing</b> 21.1303 '00-19			
		<b>Clips</b> 05.1812 '00-19					

Footnotes: \* Bearings Only \*\* Rubbers included

<b>Air Filter</b> 52.62016 '21-23	<b>Cover Gasket</b> 19.G6316 '21-23	<b>Complete Plate Set</b> 16.CPS63019 '21-23	<b>F/W Bearing</b> 23.S114002 '21-23	<b>Frontbrake Disc</b> 37.BD16290 '21-23	<b>Front Sprocket</b> 07.FS62093-12 07.FS62093-13 07.FS62093-14 07.FS62093-15 '21-23	<b>Chain</b> 07.RC520120C '21-23 MX 07.RC520120CG '21-23 MX Gold 07.RC520120XC '21-23 X-Ring 07.RC520120XCG '21-23 X-Ring Gold	<b>Swingarm</b> 26.210125 '21-23
<b>Throttle Cable</b> 53.112073 '21-23	<b>Master Cylinder Rebuild Kit</b> 16.940010 '21	<b>Friction Set</b> 16.S53016 '21-23	<b>R/W Bearing</b> 23.S112073 '21-23	<b>Rearbrake Disc</b> 37.BD26190 '21-23		<b>Upper</b> 26.450068 '21-23	
<b>Oil Filter</b> 54.63652 '21-23 1-Pce. 54.63652-50 '21-23 50-Pcs.	<b>Slave Cylinder Rebuild Kit</b> 16.950014 '21	<b>Steel Set</b> 16.S53027 '21-23	<b>F/W Spacer Kit</b> 26.710103 '21-23	<b>Front Pad Set</b> 37.102202 '21-23	<b>7075-T6 Alloy Rear Sprocket</b> 07.RA62090-48 07.RA62090-49 07.RA62090-50 07.RA62090-51 07.RA62090-52 '21-23	<b>Countershaft Seal Kit</b> 26.640001 '21-23	
			<b>R/W Spacer Kit</b> 26.710084 '21-23	<b>Front Pad Set</b> 37.102202BX '21-23 Box of 10			
			<b>Steering Bearing</b> 24.110026 '21-23	<b>Rear Pad Set</b> 37.202302 '21-23	<b>Ultralight Steel Rear Sprocket</b> 07.RS62090R-48 07.RS62090R-49 07.RS62090R-50 07.RS62090R-51 07.RS62090R-52 '21-23		
				<b>Front Caliper Rebuild Kit</b> 37.63046 '21-23	<b>Sprocket Bolt Set</b> 07.SBSM825 '21-23		
				<b>Rear Caliper Rebuild Kit</b> 37.63048 '21-23			
				<b>Front Master Cylinder Rebuild Kit</b> 37.910035 '21-23			
				<b>Rear Master Cylinder Rebuild Kit</b> 37.910030 '21-23			

**DIRT**  
APRILIA  
BETA  
BMW  
GAS GAS  
HONDA  
HUSABERG  
HUSQVARNA  
KAWASAKI  
KTM  
MOTO TM  
RIEJU  
SHERCO  
SUZUKI  
YAMAHA

**STREET**  
APRILIA  
CAGIVA  
HONDA  
KAWASAKI  
KTM  
SUZUKI  
YAMAHA

**ATV-UTV**  
CAN-AM  
GAS GAS  
HONDA  
KAWASAKI  
KTM  
POLARIS  
SUZUKI  
YAMAHA

**PWC**  
KAWASAKI  
POLARIS  
SEA DOO  
YAMAHA

**SNOW**  
ARCTIC CAT  
KAWASAKI  
LYNX  
MOTO-SKI  
POLARIS  
SKI DOO  
YAMAHA

**MOPED & SCOOTER**

**MISC. TECH. SPECIAL**



### GAS GAS

DIRT	Piston Kit	Size	Ring Set	Crank Bearing & Seal Kit	Con. Rod Kit	Complete		
EC 300 2-Stroke Please Note: Nikasil Piston Size -KTM Engine -Fuel Injection	01.6388.A 01.6388.B 01.6388.C '21-23	71.94 71.95 71.96	02.6396 02.6396 02.6396 '21-23	23.CBS63004 '21-23  <b>Bearing</b> 23.NJ207ECS '21-23 Left 23.6232X2 '21-23 Right  <b>Oilseal Set</b> 42.6320 '21-23	03.6323 '21-23  <b>S/E Bearing</b> 21.6320 '21-23  <b>B/E Bearing</b> 22.243017F '21-23  <b>Crankpin</b> 06.2459.6 '21-23	34.6317 '21-22  <b>Top-End</b> 35.6350 '21-22 35.6353 '23  <b>Head &amp; Base</b> 36.6327 '21-22 36.6333 '23  <b>Ignition Cover Gasket</b> 19.G96317 '21-23		
<b>STREET</b> APRILIA CAGIVA HONDA KAWASAKI KTM SUZUKI YAMAHA								
<b>ATV-UTV</b> CAN-AM GAS GAS HONDA KAWASAKI KTM POLARIS SUZUKI YAMAHA								
<b>PWC</b> KAWASAKI POLARIS SEA DOO YAMAHA								
<b>SNOW</b> ARCTIC CAT KAWASAKI LYNX MOTO-SKI POLARIS SKI DOO YAMAHA								
<b>MOPED &amp; SCOOTER</b>								
<b>MISC. TECH. SPECIAL</b>								

Footnotes: \* Bearings Only \*\* Rubbers included

Air Filter	Cover Gasket	Complete Plate Set	F/W Bearing	Frontbrake Disc	Front Sprocket	Chain	Swingarm
52.62016 '21-23  <b>Throttle Cable</b> 53.112072 '21-22 53.112091 '23	19.G6317 '21-23  <b>Master Cylinder Rebuild Kit</b> 16.940000 '21  <b>Slave Cylinder Rebuild Kit</b> 16.950015 '21	16.CPS64012 '21-23  <b>Friction Set</b> 16.S53011 '21-23  <b>Steel Set</b> 16.S53029 '21-23	23.S114002 '21-23  <b>R/W Bearing</b> 23.S112073 '21-23  <b>F/W Spacer Kit</b> 26.710103 '21-23  <b>R/W Spacer Kit</b> 26.710084 '21-23  <b>Steering Bearing</b> 24.110026 '21-23	37.BD16290 '21-23  <b>Rearbrake Disc</b> 37.BD26190 '21-23  <b>Front Pad Set</b> 37.102202 '21-23 37.102202BX '21-23 Box of 10  <b>Rear Pad Set</b> 37.202302 '21-23 37.202302BX '21-23 Box of 10  <b>Front Caliper Rebuild Kit</b> 37.63046 '21-23  <b>Rear Caliper Rebuild Kit</b> 37.63048 '21-23  <b>Front Master Cylinder Rebuild Kit</b> 37.910035 '21-23  <b>Rear Master Cylinder Rebuild Kit</b> 37.910030 '21-23	07.FS62093-12 07.FS62093-13 07.FS62093-14 07.FS62093-15 '21-23  <b>7075-T6 Alloy Rear Sprocket</b> 07.RA62090-48 07.RA62090-49 07.RA62090-50 07.RA62090-51 07.RA62090-52 '21-23  <b>Ultralight Steel Rear Sprocket</b> 07.RS62090R-48 07.RS62090R-49 07.RS62090R-50 07.RS62090R-51 07.RS62090R-52 '21-23  <b>Sprocket Bolt Set</b> 07.SBSM825 '21-23	07.RC520120C '21-23 MX 07.RC520120CG '21-23 MX Gold 07.RC520120XC '21-23 X-Ring 07.RC520120XCG '21-23 X-Ring Gold  <b>Countershaft Seal Kit</b> 26.640001 '21-23	26.210125 '21-23  <b>Linkage</b> 26.110180 '21-23  <b>Lower</b> 26.450066 '21-23  <b>Upper</b> 26.450068 '21-23

DIRT	GAS GAS	HONDA	HUSABERG	HUSQVARNA	KAWASAKI	KTM	MOTO TM	RIEJU	SHERCO	SUZUKI	YAMAHA
APRILIA											
BETA											
BMW											
<b>GAS GAS</b>											
HONDA											
HUSABERG											
HUSQVARNA											
KAWASAKI											
KTM											
MOTO TM											
RIEJU											
SHERCO											
SUZUKI											
YAMAHA											
<b>STREET</b>											
APRILIA											
CAGIVA											
HONDA											
KAWASAKI											
KTM											
SUZUKI											
YAMAHA											
<b>ATV-UTV</b>											
CAN-AM											
GAS GAS											
HONDA											
KAWASAKI											
KTM											
POLARIS											
SUZUKI											
YAMAHA											
<b>PWC</b>											
KAWASAKI											
POLARIS											
SEA DOO											
YAMAHA											
<b>SNOW</b>											
ARCTIC CAT											
KAWASAKI											
LYNX											
MOTO-SKI											
POLARIS											
SKI DOO											
YAMAHA											
<b>MOPED &amp; SCOOTER</b>											
<b>MISC. TECH. SPECIAL</b>											

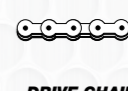

**GAS GAS**

**DIRT**  
APRILIA  
BETA  
BMW  
**GAS GAS**  
HONDA  
HUSABERG  
HUSQVARNA  
KAWASAKI  
KTM  
MOTO TM  
RIEJU  
SHERCO  
SUZUKI  
YAMAHA

EC 300 F 4-Stroke Please Note: Nikasil Piston Size -Std. Compression 12.5:1 -Forged Piston -Yamaha Engine	Piston Kit -	Size 83.00	Ring Set -	CrankBearing & Seal Kit 23.CBS24001* '13-15  Bearing 23.830046-1 '13-15 2x	Con. Rod Kit 03.2403 '13-15  B/E Bearing 22.324018F '13-15  Crankpin 06.3254.8 '13-15		Cam Chain 31.2402 '13-15  Valve Shim Assortment 29.VSA748 '13-15 29.VSA748-2 '13-15	Valve 28.2401-1 '13-15 2x Exhaust Titanium 28.2401-2 '13-15 1x Intake I Titanium 28.2401-3 '13-15 2x Intake II Titanium  TI-Steel Conversion Set 28.SES2402-1 '13-15 Exhaust 28.SIS2402-2 '13-15 Intake  Valve Seal 35.VS011 '13-15 3x Intake 35.VS012 '13-15 2x Exhaust
---	-----------------	---------------	---------------	--	---	--	---	---

**STREET**  
APRILIA  
CAGIVA  
HONDA  
KAWASAKI  
KTM  
SUZUKI  
YAMAHA

MC 350 F 4-Stroke Please Note: Nikasil Piston Size -KTM Engine -Fuel Injection -Std. Compression 14.2:1	Piston Kit 01.6351.A 01.6351.B 01.6351.C '23	Size 87.96 87.97 87.98	Ring Set 02.6351 02.6351 02.6351 '23  Pin 04.1844.4 '23  Clips 05.1812 '23	CrankBearing & Seal Kit 23.CBS63017 '23  Bearing 23.NJ206EPC-3 '23 2x  Oilseal 41.6-405561 '23	Con. Rod Kit 03.6366 '23  Crankpin 06.3259.9-1 '23	Top-End 35.6319 '23  Head & Base 36.6319 '23  Ignition Cover Gasket 19.G96316 '23	Cam Chain 31.6356 '23  Valve Shim Assortment 29.VSA890 '23 29.VSA890-2 '23  Valve Seal 35.VS029 '23 4x	Valve 28.6351-1 '23 2x Exhaust Titanium 28.6351-2 '23 2x Intake
---	--	---------------------------------	--	--	--	---	--	--

**PWC**  
KAWASAKI  
POLARIS  
SEA DOO  
YAMAHA

**SNOW**  
ARCTIC CAT  
KAWASAKI  
LYNX  
MOTO-SKI  
POLARIS  
SKI DOO  
YAMAHA

**MOPED & SCOOTER**

**MISC. TECH. SPECIAL**

Footnotes: \* Bearings Only \*\* Rubbers included

**DIRT**  
APRILIA  
BETA  
BMW  
**GAS GAS**  
HONDA  
HUSABERG  
HUSQVARNA  
KAWASAKI  
KTM  
MOTO TM  
RIEJU  
SHERCO  
SUZUKI  
YAMAHA

**STREET**  
APRILIA  
CAGIVA  
HONDA  
KAWASAKI  
KTM  
SUZUKI  
YAMAHA

Air Filter 52.73007 '13-15  Main Jet 45.100-225 '13-15 Keihin  Pilot Jet 46.040-085 '13-15 Keihin  Oil Filter 54.23140 '13-15 1-Pce. 54.23140-50 '13-15 50-Pcs.	Basket 17.2401F '13-15  Spring Kit 17.CS23034 '13-15  Clutch Cover 19.2401 '13-15  Cover Gasket 19.G2301 '13-15	Complete Plate Set 16.CPS23001 '13  Friction Set 16.S23017 '13  S24062 '14-15  Steel Set 16.S23018 '13-15	F/W Bearing 23.S113064 '13-15  R/W Bearing 23.S114058 '13-14  Steering Bearing 24.110056 '13-15	Frontbrake Disc 37.BD17095 '13-15  Rearbrake Disc 37.BD27095 '13-15  Front Pad Set 37.103202 '13-15 37.103202BX '13-15 Box of 10  Rear Pad Set 37.201302 '13-15 37.201302BX '13-15 Box of 10	Front Sprocket 07.FS22005-12 07.FS22005-13 07.FS22005-14 07.FS22005-15 '13-15  7075-T6 Alloy Rear Sprocket 07.RA62097-46 07.RA62097-47 07.RA62097-48 07.RA62097-49 07.RA62097-50 07.RA62097-51 07.RA62097-52 '13-15  Ultralight Steel Rear Sprocket 07.RS62097R-46 07.RS62097R-47 07.RS62097R-48 07.RS62097R-49 07.RS62097R-50 07.RS62097R-51 07.RS62097R-52 '13-15  Sprocket Bolt Set 07.SBSM825 '13-15	Chain 07.RC520120C '13-15 MX 07.RC520120CG '13-15 MX Gold 07.RC520120XC '13-15 X-Ring 07.RC520120XCG '13-15 X-Ring Gold  Countershaft Seal Kit 26.640020 '13-15		
---	---	--	---	--	---	---	--	--

**ATV-UTV**  
CAN-AM  
GAS GAS  
HONDA  
KAWASAKI  
KTM  
POLARIS  
SUZUKI  
YAMAHA

Air Filter 52.62016 '23  Throttle Cable 53.112073 '23  Oil Filter 54.63652 '23 1-Pce. 54.63652-50 '23 50-Pcs.	Cover Gasket 19.G6316 '23	Complete Plate Set 16.CPS63019 '23  Friction Set 16.S53016 '23  Steel Set 16.S53027 '23	F/W Bearing 23.S114002 '23  R/W Bearing 23.S112073 '23  F/W Spacer Kit 26.710103 '23  R/W Spacer Kit 26.710102 '23  Steering Bearing 24.110026 '23	Frontbrake Disc 37.BD16290 '23  Rearbrake Disc 37.BD26190 '23  Front Pad Set 37.102202 '23 37.102202BX '23 Box of 10  Rear Pad Set 37.202302 '23 37.202302BX '23 Box of 10  Front Caliper Rebuild Kit 37.63046 '23  Rear Caliper Rebuild Kit 37.63048 '23  Front Master Cylinder Rebuild Kit 37.910035 '23  Rear Master Cylinder Rebuild Kit 37.910030 '23	Front Sprocket 07.FS62093-12 07.FS62093-13 07.FS62093-14 07.FS62093-15 '23  7075-T6 Alloy Rear Sprocket 07.RA62090-48 07.RA62090-49 07.RA62090-50 07.RA62090-51 07.RA62090-52 '23  Ultralight Steel Rear Sprocket 07.RS62090R-48 07.RS62090R-49 07.RS62090R-50 07.RS62090R-51 07.RS62090R-52 '23  Sprocket Bolt Set 07.SBSM825 '23	Chain 07.RC520120C '23 MX 07.RC520120CG '23 MX Gold 07.RC520120XC '23 X-Ring 07.RC520120XCG '23 X-Ring Gold  Countershaft Seal Kit 26.640001 '23	Swingarm 26.210125 '23  Upper 26.450068 '23	
---	---------------------------------	---	--	--	---	--	---	--

**PWC**  
KAWASAKI  
POLARIS  
SEA DOO  
YAMAHA

**SNOW**  
ARCTIC CAT  
KAWASAKI  
LYNX  
MOTO-SKI  
POLARIS  
SKI DOO  
YAMAHA

**MOPED & SCOOTER**

**MISC. TECH. SPECIAL**



**GAS GAS**

	EC 350 F	Piston Kit	Size	Ring Set	CrankBearing & Seal Kit	Con. Rod Kit	Top-End	Cam Chain	Valve
<b>DIRT</b>	4-Stroke Please Note: Nikasil Piston Size -KTM Engine -Fuel Injection -Std. Compression 13.5:1	01.6351.A 01.6351.B 01.6351.C '21-23	87.96 87.97 87.98	02.6351 02.6351 02.6351 '21-23	23.CBS63017 '21-23	03.6366 '21-23	35.6319 '21-23	31.6356 '21-23	28.6362-1 '21-23 2x Exhaust Steel 28.6362-2 '21-23 2x Intake Steel
<b>GAS GAS</b>					<b>Bearing</b> 23.NJ206EPC-3 '21-23 2x	<b>Crankpin</b> 06.3259.9-1 '21-23	<b>Head &amp; Base</b> 36.6319 '21-23	<b>Valve Shim Assortment</b> 29.VSA890 '21-23	
<b>HONDA</b>				<b>Pin</b> 04.1844.4 '21-23				<b>Valve Seal</b> 35.VS029 '21-23 4x	
<b>HUSABERG</b>				<b>Clips</b> 05.1812 '21-23					
<b>HUSQVARNA</b>					<b>Oilseal</b> 41.6-405561 '21-23 Left		<b>Ignition Cover Gasket</b> 19.G96316 '21-23		
<b>KAWASAKI</b>									
<b>KTM</b>									
<b>MOTO TM</b>									
<b>RIEJU</b>									
<b>SHERCO</b>									
<b>SUZUKI</b>									
<b>YAMAHA</b>									
<b>STREET</b>									
<b>ATV-UTV</b>	EX 350 F 4-Stroke Please Note: Nikasil Piston Size -KTM Engine -Fuel Injection -Std. Compression 14.2:1	01.6351.A 01.6351.B 01.6351.C '21-23	87.96 87.97 87.98	02.6351 02.6351 02.6351 '21-23	23.CBS63017 '21-23	03.6366 '21-23	35.6319 '21-23	31.6356 '21-23	28.6351-1 '21-23 2x Exhaust Titanium 28.6351-2 '21-23 2x Intake
<b>CAN-AM</b>					<b>Bearing</b> 23.NJ206EPC-3 '21-23 2x	<b>Crankpin</b> 06.3259.9-1 '21-23	<b>Head &amp; Base</b> 36.6319 '21-23	<b>Valve Shim Assortment</b> 29.VSA890 '21-23	
<b>GAS GAS</b>				<b>Pin</b> 04.1844.4 '21-23				<b>Valve Seal</b> 35.VS029 '21-23 4x	
<b>HONDA</b>				<b>Clips</b> 05.1812 '21-23					
<b>KAWASAKI</b>					<b>Oilseal</b> 41.6-405561 '21-23		<b>Ignition Cover Gasket</b> 19.G96316 '21-23		
<b>KTM</b>									
<b>POLARIS</b>									
<b>SUZUKI</b>									
<b>YAMAHA</b>									
<b>PWC</b>									
<b>SNOW</b>									
<b>MOPED &amp; SCOOTER</b>									
<b>MISC. TECH. SPECIAL</b>									

Footnotes: \* Bearings Only \*\* Rubbers included

	Air Filter	Cover Gasket	Complete Plate Set	F/W Bearing	Frontbrake Disc	Front Sprocket	Chain	Swingarm
	52.62016 '21-23	19.G6316 '21-23	16.CPS64012 '21-23	23.S114002 '21-23	37.BD16290 '21-23	07.FS62093-12 07.FS62093-13 07.FS62093-14 07.FS62093-15 '21-23	07.RC520120C '21-23 MX 07.RC520120CG '21-23 MX Gold 07.RC520120XC '21-23 X-Ring 07.RC520120XCG '21-23 X-Ring Gold	26.210125 '21-23
<b>Throttle Cable</b>	53.112072 '21-23		<b>Friction Set</b> 16.S53011 '21-23	<b>R/W Bearing</b> 23.S112073 '21-23	<b>Rearbrake Disc</b> 37.BD26190 '21-23			<b>Linkage</b> 26.110180 '21-23
<b>Oil Filter</b>	54.63652 '21-23 1-Pce. 54.63652-50 '21-23 50-Pcs.		<b>Steel Set</b> 16.S53029 '21-23	<b>F/W Spacer Kit</b> 26.710103 '21-23	<b>Front Pad Set</b> 37.102202 '21-23 37.102202BX '21-23 Box of 10	<b>7075-T6 Alloy Rear Sprocket</b> 07.RA62090-48 07.RA62090-49 07.RA62090-50 07.RA62090-51 07.RA62090-52 '21-23	<b>Countershaft Seal Kit</b> 26.640001 '21-23	<b>Lower</b> 26.450066 '21-23
				<b>R/W Spacer Kit</b> 26.710084 '21-23	<b>Rear Pad Set</b> 37.202302 '21-23 37.202302BX '21-23 Box of 10	<b>Ultralight Steel Rear Sprocket</b> 07.RS62090R-48 07.RS62090R-49 07.RS62090R-50 07.RS62090R-51 07.RS62090R-52 '21-23		<b>Upper</b> 26.450068 '21-23
				<b>Steering Bearing</b> 24.110026 '21-23	<b>Front Caliper Rebuild Kit</b> 37.63046 '21-23		<b>Sprocket Bolt Set</b> 07.SBSM825 '21-23	
					<b>Rear Caliper Rebuild Kit</b> 37.63048 '21-23			
					<b>Front Master Cylinder Rebuild Kit</b> 37.910035 '21-23			
					<b>Rear Master Cylinder Rebuild Kit</b> 37.910030 '21-23			

	Air Filter	Cover Gasket	Complete Plate Set	F/W Bearing	Frontbrake Disc	Front Sprocket	Chain	Swingarm
<b>DIRT</b>	52.62016 '21-23	19.G6316 '21-23	16.CPS64012 '21-23	23.S114002 '21-23	37.BD16290 '21-23	07.FS62093-12 07.FS62093-13 07.FS62093-14 07.FS62093-15 '21-23	07.RC520120C '21-23 MX 07.RC520120CG '21-23 MX Gold 07.RC520120XC '21-23 X-Ring 07.RC520120XCG '21-23 X-Ring Gold	26.210125 '21-23
<b>STREET</b>								
<b>ATV-UTV</b>								
<b>PWC</b>								
<b>SNOW</b>								
<b>MOPED &amp; SCOOTER</b>								
<b>MISC. TECH. SPECIAL</b>								





**GAS GAS**

<b>DIRT</b> APRILIA BETA BMW GAS GAS HONDA HUSABERG HUSQVARNA KAWASAKI KTM MOTO TM RIEJU SHERCO SUZUKI YAMAHA	EC 450 4-Stroke Please Note: Nikasil Piston Size -GasGas Engine	Piston Kit -	Size 97.00	Ring Set -				Cam Chain 31.3403 '03-09	
<b>STREET</b> APRILIA CAGIVA HONDA KAWASAKI KTM SUZUKI YAMAHA									
<b>ATV-UTV</b> CAN-AM GAS GAS HONDA KAWASAKI KTM POLARIS SUZUKI YAMAHA	EC 450 F 4-Stroke Please Note: Nikasil Piston Size -Std. Compression 12.5:1 -Forged Piston -Yamaha Engine  Replating or Cylinder Sleaving Required for Oversizes	Piston Kit 01.2429.A 01.2429.B 01.2429.C & 01.2424.200 '13-15	Size 94.95 94.96 94.97 97.00	Ring Set 02.2421 02.2421 02.2421 - '13-15  Clips 05.1814 '13-15	CrankBearing & Seal Kit 23.CBS24098* '13-15  Bearing 23.83CO72C '13-15 2x	Con. Rod Kit 03.2432 '13-15  B/E Bearing 22.344220F '13-15  Washers 03W.34540.5 '13-15 2x  Crankpin 06.3460.8 '13-15	Head & Base 36.2406 '13-15	Cam Chain 31.2423 '13-15  Valve Shim Assortment 29.VSA948 '13-15 29.VSA948-2 '13-15	Valve 28.2423-1 '13-15 2x Exhaust Titanium 28.2423-2 '13-15 1x Intake I Titanium 28.2423-3 '13-15 2x Intake II Titanium  Ti-Steel Conversion Set 28.SES2424-1 '13-15 Exhaust 28.SIS2424-2 '13-15 Intake  Valve Seal 35.VS012 '13-15 3x Intake 35.VS013 '13-15 2x Exhaust
<b>PWC</b> KAWASAKI POLARIS SEA DOO YAMAHA									
<b>SNOW</b> ARCTIC CAT KAWASAKI LYNX MOTO-SKI POLARIS SKI DOO YAMAHA									
<b>MOPED &amp; SCOOTER</b>									
<b>MISC. TECH. SPECIAL</b>									

Footnotes: \* Bearings Only \*\* Rubbers included

Air Filter 52.72092 '03-06  Oil Filter 54.44113 '09 1-Pce. 54.44113-50 '09 50-Pcs.			F/W Bearing 23.S113064 '05-09  R/W Bearing 23.S114058 '05-09  Steering Bearing 24.110044 '05 24.110056 '06-09	Frontbrake Disc 37.BD17095 '03-09  Rearbrake Disc 37.BD27095 '03-09  Front Pad Set 37.103202 '05-09 37.103202BX '05-09 Box of 10  Rear Pad Set 37.207102 '05-09 37.207102BX '05-09 Box of 10  UltraLight Steel Rear Sprocket 07.RS62097R-46 07.RS62097R-47 07.RS62097R-48 07.RS62097R-49 07.RS62097R-50 07.RS62097R-51 07.RS62097R-52 '03-09  Sprocket Bolt Set 07.SBSM825 '03-09	7075-T6 Alloy Rear Sprocket 07.RA62097-46 07.RA62097-47 07.RA62097-48 07.RA62097-49 07.RA62097-50 07.RA62097-51 07.RA62097-52 '03-09  UltraLight Steel Rear Sprocket 07.RS62097R-46 07.RS62097R-47 07.RS62097R-48 07.RS62097R-49 07.RS62097R-50 07.RS62097R-51 07.RS62097R-52 '03-09  Sprocket Bolt Set 07.SBSM825 '03-09	Chain 07.RC520120C '03-09 MX 07.RC520120CG '03-09 MX Gold 07.RC520120XC '03-09 X-Ring 07.RC520120XCG '03-09 X-Ring Gold  Sprocket Bolt Set 07.SBSM825 '03-09	Swingarm 26.210116 '05-09  Linkage 26.110118 '05-09  Lower 26.450046 '05-09		
Air Filter 52.73007 '13-15  Main Jet 45.100-225 '13-15 Keihin  Pilot Jet 46.040-085 '13-15 Keihin  Oil Filter 54.23140 '13-15 1-Pce. 54.23140-50 '13-15 50-Pcs.	Basket 17.2424F * '13-15  Clutch Rubber Set 17.CRS2424-8 '13-15  Spring Kit 17.CS23033 '13-15  Cover Gasket 19.G2423 '13-15	Complete Plate Set 16.CPS24015 '13-15  Friction Set 16.S24041 '13-15  Steel Set 16.S24025 '13-15	F/W Bearing 23.S113064 '13-15  R/W Bearing 23.S114058 '13-15  Steering Bearing 24.110056 '13-15	Frontbrake Disc 37.BD17095 '03-15  Rearbrake Disc 37.BD27095 '03-15  Front Pad Set 37.103202 '13-15 37.103202BX '13-15 Box of 10  Rear Pad Set 37.201302 '13-15 37.201302BX '13-15 Box of 10  UltraLight Steel Rear Sprocket 07.RS62097R-46 07.RS62097R-47 07.RS62097R-48 07.RS62097R-49 07.RS62097R-50 07.RS62097R-51 07.RS62097R-52 '13-15  Sprocket Bolt Set 07.SBSM825 '13-15	Chain 07.RC520120C '13-15 MX 07.RC520120CG '13-15 MX Gold 07.RC520120XC '13-15 X-Ring 07.RC520120XCG '13-15 X-Ring Gold  Countershaft Seal Kit 26.640019 '13-15				

<b>DIRT</b> APRILIA BETA BMW GAS GAS HONDA HUSABERG HUSQVARNA KAWASAKI KTM MOTO TM RIEJU SHERCO SUZUKI YAMAHA	
<b>STREET</b> APRILIA CAGIVA HONDA KAWASAKI KTM SUZUKI YAMAHA	
<b>ATV-UTV</b> CAN-AM GAS GAS HONDA KAWASAKI KTM POLARIS SUZUKI YAMAHA	
<b>PWC</b> KAWASAKI POLARIS SEA DOO YAMAHA	
<b>SNOW</b> ARCTIC CAT KAWASAKI LYNX MOTO-SKI POLARIS SKI DOO YAMAHA	
<b>MOPED &amp; SCOOTER</b>	
<b>MISC. TECH. SPECIAL</b>	





**GAS GAS**

**DIRT**  
APRILIA  
BETA  
BMW  
GAS GAS  
HONDA  
HUSABERG  
HUSQVARNA  
KAWASAKI  
KTM  
MOTO TM  
RIEJU  
SHERCO  
SUZUKI  
YAMAHA

MC 450 F 4-Stroke Please Note: Nikasil Piston Size -KTM Engine -Fuel Injection -Std. Comp 12.75:1	<b>Piston Kit</b> 01.6433.A 01.6433.B 01.6433.C '21-23	<b>Size</b> 94.95 94.96 94.97	<b>Ring Set</b> 02.6429 02.6429 02.6429 '21-23	<b>CrankBearing &amp; Seal Kit</b> 23.CBS64016 '21-23	<b>Con. Rod Kit</b> 03.6436 '21-23	<b>Top-End</b> 35.6419 '21-23	<b>Cam Chain</b> 31.1335 '21-23	<b>Valve</b> 28.6419-1 '21-23 2x Exhaust Titanium 28.6419-2 '21-23 2x Intake Titanium
			<b>Clips</b> 05.1912 '21-23	<b>Bearing</b> 23.NJ207ECP-1 21-23 2x	<b>Crankpin</b> 06.3562 '21-23	<b>Head &amp; Base</b> 36.6416 '21-23	<b>Valve Shim Assortment</b> 29.VSA890 '21-23	<b>Valve Seal</b> 35.VS026 '21-23 4x
						<b>Ignition Cover Gasket</b> 19.G96416 '21-23		

**STREET**  
APRILIA  
CAGIVA  
HONDA  
KAWASAKI  
KTM  
SUZUKI  
YAMAHA

**ATV-UTV**  
CAN-AM  
GAS GAS  
HONDA  
KAWASAKI  
KTM  
POLARIS  
SUZUKI  
YAMAHA

**PWC**  
KAWASAKI  
POLARIS  
SEA DOO  
YAMAHA

**SNOW**  
ARCTIC CAT  
KAWASAKI  
LYNX  
MOTO-SKI  
POLARIS  
SKI DOO  
YAMAHA

**MOPED & SCOOTER**

**MISC. TECH. SPECIAL**

Footnotes: \* Bearings Only \*\* Rubbers included

**DIRT**  
APRILIA  
BETA  
BMW  
GAS GAS  
HONDA  
HUSABERG  
HUSQVARNA  
KAWASAKI  
KTM  
MOTO TM  
RIEJU  
SHERCO  
SUZUKI  
YAMAHA

**STREET**  
APRILIA  
CAGIVA  
HONDA  
KAWASAKI  
KTM  
SUZUKI  
YAMAHA

**ATV-UTV**  
CAN-AM  
GAS GAS  
HONDA  
KAWASAKI  
KTM  
POLARIS  
SUZUKI  
YAMAHA

**PWC**  
KAWASAKI  
POLARIS  
SEA DOO  
YAMAHA

**SNOW**  
ARCTIC CAT  
KAWASAKI  
LYNX  
MOTO-SKI  
POLARIS  
SKI DOO  
YAMAHA

**MOPED & SCOOTER**

**MISC. TECH. SPECIAL**

<b>Air Filter</b> 52.62016 '21-23	<b>Cover Gasket</b> 19.G6414 '21-23	<b>Complete Plate Set</b> 16.CPS64012 '21-23	<b>F/W Bearing</b> 23.S114002 '21-23	<b>Frontbrake Disc</b> 37.BD16290 '21-23	<b>Front Sprocket</b> 07.FS62093-12 07.FS62093-13 07.FS62093-14 07.FS62093-15 '21-23	<b>Chain</b> 07.RC520120C '21-23 MX 07.RC520120CG '21-23 MX Gold 07.RC520120XC '21-23 X-Ring 07.RC520120XCG '21-23 X-Ring Gold	<b>Swingarm</b> 26.210125 '21-23
<b>Throttle Cable</b> 53.112073 '21-23	<b>Master Cylinder Rebuild Kit</b> 16.940000 '21	<b>Friction Set</b> 16.S53011 '21-23	<b>R/W Bearing</b> 23.S112073 '21-23	<b>Rearbrake Disc</b> 37.BD26190 '21-23			<b>Upper</b> 26.450068 '21-23
<b>Oil Filter</b> 54.63652 '21-23 1-Pce. 54.63652-50 '21-23 50-Pcs.	<b>Slave Cylinder Rebuild Kit</b> 16.950003 '21	<b>Steel Set</b> 16.S53029 '21-23	<b>F/W Spacer Kit</b> 26.710103 '21-23	<b>Front Pad Set</b> 37.102202 '21-23	<b>7075-T6 Alloy Rear Sprocket</b> 07.RA62090-48 07.RA62090-49 07.RA62090-50 07.RA62090-51 07.RA62090-52 '21-23	<b>Countershaft Seal Kit</b> 26.640001 '21-23	
			<b>R/W Spacer Kit</b> 26.710102 '21-23	<b>Rear Pad Set</b> 37.202302 '21-23	<b>Ultralight Steel Rear Sprocket</b> 07.RS62090R-48 07.RS62090R-49 07.RS62090R-50 07.RS62090R-51 07.RS62090R-52 '21-23		
			<b>Steering Bearing</b> 24.110026 '21-23	<b>Front Caliper Rebuild Kit</b> 37.63046 '21-23	<b>Sprocket Bolt Set</b> 07.SBSM825 '21-23		
				<b>Rear Caliper Rebuild Kit</b> 37.63048 '21-23			
				<b>Front Master Cylinder Rebuild Kit</b> 37.910035 '21-23			
				<b>Rear Master Cylinder Rebuild Kit</b> 37.910030 '21-23			



**GAS GAS**

<b>DIRT</b> APRILIA BETA BMW GAS GAS HONDA HUSABERG HUSQVARNA KAWASAKI KTM MOTO TM RIEJU SHERCO SUZUKI YAMAHA	SM 450 4-Stroke Please Note: Nikasil Piston Size -GasGas Engine	Piston Kit -	Size 97.00	Ring Set -				Cam Chain 31.3403 '07-09
---	---	-----------------	---------------	---------------	--	--	--	--------------------------------

**HONDA**

<b>STREET</b> APRILIA CAGIVA HONDA KAWASAKI KTM SUZUKI YAMAHA	Z-50 R 4-Stroke	Piston Kit -	Size -	Ring Set -				Valve Seal 35.VS003 '88-99 1x Intake 35.VS003 '88-99 1x Exhaust
--	--------------------	-----------------	-----------	---------------	--	--	--	---

<b>PWC</b> KAWASAKI POLARIS SEA DOO YAMAHA	XR 50 R 4-Stroke	Piston Kit -	Size 39.00	Ring Set -	Bearing 23.6304C3 '00-03 2x	Con. Rod Kit 03.1090 '00-03	Top-End 35.1040 '00-03	Valve Seal 35.VS003 '00-03 1x Intake 35.VS003 '00-03 1x Exhaust
--	---------------------	-----------------	---------------	---------------	-----------------------------------	-----------------------------------	------------------------------	---

<b>SNOW</b> ARCTIC CAT KAWASAKI LYNX MOTO-SKI POLARIS SKI DOO YAMAHA	CRF 50 F 4-Stroke	Piston Kit -	Size 39.00	Ring Set -	Bearing 23.6304C3 '04-12 2x	Con. Rod Kit 03.1090 '04-12	Top-End 35.1040 '04-20	Valve Seal 35.VS003 '04-23 1x Intake 35.VS003 '04-23 1x Exhaust
---	----------------------	-----------------	---------------	---------------	-----------------------------------	-----------------------------------	------------------------------	---

<b>MOPED &amp; SCOOTER</b>								
<b>MISC. TECH. SPECIAL</b>								

Footnotes: \* Bearings Only \*\* Rubbers included

<b>DIRT</b> APRILIA BETA BMW GAS GAS HONDA HUSABERG HUSQVARNA KAWASAKI KTM MOTO TM RIEJU SHERCO SUZUKI YAMAHA	Oil Filter 54.44113 '03-09 1-Pce. 54.44113-50 '03-09 50-Pcs.			F/W Bearing 23.S113064 '07-09  R/W Bearing 23.S114058 '07-09  Steering Bearing 24.110056 '07-09		Front Sprocket 07.FS73000-12 07.FS73000-13 '07-09  7075-T6 Alloy Rear Sprocket 07.RA62097-46 07.RA62097-47 07.RA62097-48 07.RA62097-49 07.RA62097-50 07.RA62097-51 07.RA62097-52 '07-09  Ultralight Steel Rear Sprocket 07.RS62097R-46 07.RS62097R-47 07.RS62097R-48 07.RS62097R-49 07.RS62097R-50 07.RS62097R-51 07.RS62097R-52 '07-09  Sprocket Bolt Set 07.SBSM825 '07-09	Chain 07.RC520120C '07-09 MX 07.RC520120CG '07-09 MX Gold 07.RC520120XC '07-09 X-Ring 07.RC520120XCG '07-09 X-Ring Gold	Swingarm 26.210116 '07-09  Linkage 26.110118 '07-09  Lower 26.450046 '07-09
---	--	--	--	---	--	---	---	---

<b>STREET</b> APRILIA CAGIVA HONDA KAWASAKI KTM SUZUKI YAMAHA	Throttle Cable 53.111070 '86-99			F/W Bearing 23.S111072 '69-99  R/W Bearing 23.S111072 '94-99  Steering Bearing 24.110002 '72-99			Chain 07.RC420130C '91-99 MX	Swingarm 26.210163 '73-99
--	---------------------------------------	--	--	---	--	--	------------------------------------	---------------------------------

<b>PWC</b> KAWASAKI POLARIS SEA DOO YAMAHA	Throttle Cable 53.111070 '00-03			F/W Bearing 23.S111070 '00-03  R/W Bearing 23.S111067 '00-03  Steering Bearing 24.110002 '00-03		Front Sprocket 07.FS11086-13 07.FS11086-14 07.FS11086-15 07.FS11086-16 '00-03	Chain 07.RC420130C '00-03 MX	Swingarm 26.210163 '00-03
--	---------------------------------------	--	--	---	--	--	------------------------------------	---------------------------------

<b>SNOW</b> ARCTIC CAT KAWASAKI LYNX MOTO-SKI POLARIS SKI DOO YAMAHA	Throttle Cable 53.111070 '04-12			F/W Bearing 23.S111070 '04-23  R/W Bearing 23.S111067 '04-23  Steering Bearing 24.110002 '04-23		Front Sprocket 07.FS11086-13 07.FS11086-14 07.FS11086-15 07.FS11086-16 '04-23	Chain 07.RC420130C '04-23 MX	Swingarm 26.210163 '04-23
---	---------------------------------------	--	--	---	--	--	------------------------------------	---------------------------------

<b>MOPED &amp; SCOOTER</b>								
<b>MISC. TECH. SPECIAL</b>								





**HONDA**

**DIRT**  
APRILIA  
BETA  
BMW  
GAS GAS  
HONDA  
HUSABERG  
HUSQVARNA  
KAWASAKI  
KTM  
MOTO TM  
RIEJU  
SHERCO  
SUZUKI  
YAMAHA

XR 70 R 4-Stroke	<b>Piston Kit</b> 01.1075.000 01.1075.050 01.1075.100 '97-03	<b>Size</b> 47.00 47.50 48.00	<b>Ring Set</b> - - -	<b>Bearing</b> 23.6304C3 '97-03 2x	<b>Con. Rod Kit</b> 03.1075 '97-03	<b>Top-End</b> 35.1070 '97-03	<b>Valve</b> 28.1070-1 '97-03 1x Exhaust Steel 28.1070-2 '97-03 1x Intake Steel <b>Valve Seal</b> 35.VS003 '97-03 1x Intake 35.VS003 '97-03 1x Exhaust
CRF 70 F 4-Stroke	<b>Piston Kit</b> 01.1075.000 01.1075.050 01.1075.100 '04-12	<b>Size</b> 47.00 47.50 48.00	<b>Ring Set</b> - - -	<b>Bearing</b> 23.6304C3 '04-12 2x	<b>Con. Rod Kit</b> 03.1075 '04-12	<b>Top-End</b> 35.1070 '04-12	<b>Valve</b> 28.1070-1 '04-12 1x Exhaust Steel 28.1070-2 '04-12 1x Intake Steel <b>Valve Seal</b> 35.VS003 '04-12 1x Intake 35.VS003 '04-12 1x Exhaust

**STREET**  
APRILIA  
CAGIVA  
HONDA  
KAWASAKI  
KTM  
SUZUKI  
YAMAHA

MT 80 2-Stroke	<b>Piston Kit</b> -	<b>Size</b> -	<b>Ring Set</b> -		<b>Con. Rod Kit</b> 03.1103 <b>S/E Bearing</b> 21.1103 <b>B/E Bearing</b> 22.202614F		
MTX 80 2-Stroke	<b>Piston Kit</b> -	<b>Size</b> -	<b>Ring Set</b> -		<b>Con. Rod Kit</b> 03.1102 <b>S/E Bearing</b> 21.1003 <b>B/E Bearing</b> 22.182414		

**ATV-UTV**  
CAN-AM  
GAS GAS  
HONDA  
KAWASAKI  
KTM  
POLARIS  
SUZUKI  
YAMAHA

XR 80 R 4-Stroke	<b>Piston Kit</b> -	<b>Size</b> 47.50	<b>Ring Set</b> -			<b>Ignition Cover Gasket</b> 19.G91104 '85-03	
---------------------	------------------------	----------------------	----------------------	--	--	---	--

**PWC**  
KAWASAKI  
POLARIS  
SEA DOO  
YAMAHA

CRF 80 F 4-Stroke	<b>Piston Kit</b> -	<b>Size</b> 47.50	<b>Ring Set</b> -				<b>Valve Seal</b> 35.VS001 '04-13 1x Intake 35.VS001 '04-13 1x Exhaust
----------------------	------------------------	----------------------	----------------------	--	--	--	--

**SNOW**  
ARCTIC CAT  
KAWASAKI  
LYNX  
MOTO-SKI  
POLARIS  
SKI DOO  
YAMAHA

--	--	--	--	--	--	--	--

Footnotes: \* Bearings Only \*\* Rubbers included

<b>Throttle Cable</b> 53.111035 '97-03			<b>F/W Bearing</b> 23.S110027 '97-03 <b>R/W Bearing</b> 23.S111091 '97-03 <b>Steering Bearing</b> 24.110002 '97-03	<b>Front Sprocket</b> 07.FS11086-13 07.FS11086-14 07.FS11086-15 07.FS11086-16 '97-03	<b>Chain</b> 07.RC420130C '97-03 MX	<b>Swingarm</b> 26.210163 '97-03
--	--	--	--	---	---	--

<b>Throttle Cable</b> 53.111035 '04-12			<b>F/W Bearing</b> 23.S110027 '04-12 <b>R/W Bearing</b> 23.S111091 '04-12 <b>Steering Bearing</b> 24.110002 '04-12	<b>Front Sprocket</b> 07.FS11086-13 07.FS11086-14 07.FS11086-15 07.FS11086-16 '04-12	<b>Chain</b> 07.RC420130C '04-12 MX	<b>Swingarm</b> 26.210163 '04-12
--	--	--	--	---	---	--

--	--	--	--	--	--	--

<b>Air Filter</b> 52.11088 '88-03 <b>Main Jet</b> 45.116070-120 '00-03 Keihin <b>Throttle Cable</b> 53.110001 '83-85 53.110003 '86-03	<b>Clutch Cable</b> 53.120005 '79-03	<b>Friction Set</b> 16.S10029 '79-03	<b>F/W Bearing</b> 23.S110027 '85-03 <b>R/W Bearing</b> 23.S111091 '85-03 <b>Steering Bearing</b> 24.110002 '85-03		<b>Chain</b> 07.RC420130C '79-03 MX	<b>Swingarm</b> 26.210090 '85-03 <b>Linkage</b> 26.110091 '85-03 <b>Lower</b> 26.450017 '85-03
---	--	--	--	--	---	--

<b>Air Filter</b> 52.11088 '04-13 <b>Main Jet</b> 45.116070-120 '04-13 Keihin <b>Throttle Cable</b> 53.110003 '04-13	<b>Clutch Cable</b> 53.120005 '04-13	<b>Friction Set</b> 16.S10029 '04-13	<b>F/W Bearing</b> 23.S110027 '04-13 <b>R/W Bearing</b> 23.S111091 '04-13 <b>Steering Bearing</b> 24.110002 '04-13		<b>Chain</b> 07.RC420130C '04-13 MX	<b>Swingarm</b> 26.210090 '04-13 <b>Linkage</b> 26.110091 '04-13 <b>Lower</b> 26.450017 '04-13
--	--	--	--	--	---	--

**DIRT**  
APRILIA  
BETA  
BMW  
GAS GAS  
HONDA  
HUSABERG  
HUSQVARNA  
KAWASAKI  
KTM  
MOTO TM  
RIEJU  
SHERCO  
SUZUKI  
YAMAHA

**STREET**  
APRILIA  
CAGIVA  
HONDA  
KAWASAKI  
KTM  
SUZUKI  
YAMAHA

**ATV-UTV**  
CAN-AM  
GAS GAS  
HONDA  
KAWASAKI  
KTM  
POLARIS  
SUZUKI  
YAMAHA

**PWC**  
KAWASAKI  
POLARIS  
SEA DOO  
YAMAHA

**SNOW**  
ARCTIC CAT  
KAWASAKI  
LYNX  
MOTO-SKI  
POLARIS  
SKI DOO  
YAMAHA

**MOPED & SCOOTER**

**MISC. TECH. SPECIAL**

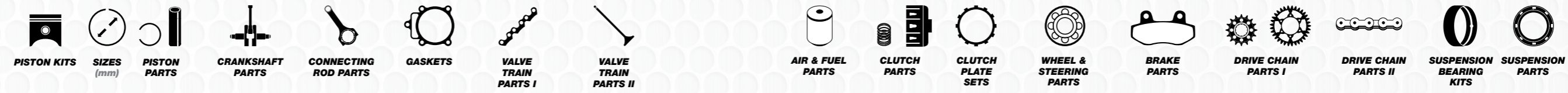

**HONDA**

**DIRT**  
 APRILIA  
 BETA  
 BMW  
 GAS GAS  
**HONDA**  
 HUSABERG  
 HUSQVARNA  
 KAWASAKI  
 KTM  
 MOTO TM  
 RIEJU  
 SHERCO  
 SUZUKI  
 YAMAHA

**STREET**  
 APRILIA  
 CAGIVA  
 HONDA  
 KAWASAKI  
 KTM  
 SUZUKI  
 YAMAHA

**ATV-UTV**  
 CAN-AM  
 GAS GAS  
 HONDA  
 KAWASAKI  
 KTM  
 POLARIS  
 SUZUKI  
 YAMAHA

**PWC**  
 KAWASAKI  
 POLARIS  
 SEA DOO  
 YAMAHA

**SNOW**  
 ARCTIC CAT  
 KAWASAKI  
 LYNX  
 MOTO-SKI  
 POLARIS  
 SKI DOO  
 YAMAHA

**MOPED & SCOOTER**

**MISC. TECH. SPECIAL**

CR 80 International Bore 79cc 2-Stroke Please Note: Nikasil Piston Size	<b>Piston Kit</b> 01.1110.B 01.1110.C '86-02	<b>Size</b> 45.95 45.96	<b>Ring Set</b> 02.1110 02.1110 '86-02	<b>Crankshaft</b> 10.1186 '86-02	<b>Con. Rod Kit</b> 03.1105 '86-02	<b>Complete</b> 34.1106 '86-91 34.1112 '92-02	<b>Crank Bearing &amp; Seal Kit</b> 21.1111 '86-02	<b>S/E Bearing</b> '86-02	<b>Top-End</b> 35.1110 '86-91 35.1112 '92-02	<b>Head &amp; Base</b> 36.1103 '92-02	<b>Ignition Cover Gasket</b> 19.G91185 '85-02
USA Bore 82cc 2-Stroke Please Note: Nikasil Piston Size	<b>Piston Kit</b> 01.1111.B 01.1111.C '86-02	<b>Size</b> 46.95 46.96	<b>Ring Set</b> 02.1111 02.1111 '86-02	<b>Crankshaft</b> 23.CBS11085 '85-02	<b>Con. Rod Kit</b> 06.2045 '86-02	<b>Complete</b> 35.1110 '86-91 35.1112 '92-02	<b>Crank Bearing &amp; Seal Kit</b> 23.6322C4 '85-02 2x	<b>S/E Bearing</b> 22.202614F '86-02	<b>Top-End</b> 35.1110 '86-91 35.1112 '92-02	<b>Head &amp; Base</b> 36.1103 '92-02	<b>Ignition Cover Gasket</b> 19.G91185 '85-02
			<b>Pin</b> 04.1439 '86-02								
			<b>Clips</b> 05.1410C '86-02								

Footnotes: \* Bearings Only \*\* Rubbers included

<b>Air Filter</b> 52.11086 '86-02	<b>Basket</b> 17.1186F '86-02	<b>Complete Plate Set</b> 16.CPS11087 '87-02	<b>F/W Bearing</b> 23.S110027 '86-02	<b>Frontbrake Disc</b> 37.BD11196 '96-02	<b>Front Sprocket</b> 07.FS11086-13 07.FS11086-14 07.FS11086-15 07.FS11086-16 '86-02	<b>Chain</b> 07.RC420130C '86-02 MX	<b>Swingarm</b> 26.210017 '86-95 26.210016 '96-97 26.210018 '98-99 26.210019 '00-02	<b>Seal &amp; Wiper</b> 40.S354811 '87-91 40.S36488P '92-95 40.S375011 '96-02
<b>Main Jet</b> 45.100-225 '95-02 Keihin	<b>Pressure Plate</b> 18.P1110 '90-02	<b>Friction Set</b> 16.S11001 '87-02	<b>R/W Bearing</b> 23.S111060 '86-02	<b>Rearbrake Disc</b> 37.BD21192 '92-02	<b>7075-T6 Alloy Rear Sprocket</b> 07.RA11086-50 07.RA11086-52 07.RA11086-53 07.RA11086-55 07.RA11086-56 '86-02	<b>Lower Chain Roller</b> 33.0011 '96-02		
<b>Pilot Jet</b> 46.040-085 '95-02 Keihin	<b>Spring Kit</b> 17.CS11001 '84-02	<b>Steel Set</b> 16.S11002 '87-02	<b>F/W Spacer Kit</b> 26.710001 '86-02	<b>Front Pad Set</b> 37.200802 '86-02				
<b>Carburetor Rebuild Kit</b> 55.10247 '96-02	<b>Cover Gasket</b> 19.G1185 '85-02		<b>R/W Spacer Kit</b> 26.710012 '96-02	<b>37.200802BX</b> '86-02 Box of 10				
<b>Throttle Cable</b> 53.110001 '84-95 53.110002 '96-02	<b>Clutch Cable</b> 53.120006 '80-02		<b>Steering Bearing</b> 24.110021 '87-02	<b>Rear Pad Set</b> 37.207102 '92-02				
<b>Water Pump Rebuild Kit</b> 57.1015 '85-02				<b>37.207102BX</b> '92-02 Box of 10				
				<b>Front Caliper Rebuild Kit</b> 37.63002 '86-92 37.63003 '93-02				
				<b>Rear Caliper Rebuild Kit</b> 37.63028 '92-02				
				<b>Front Master Cylinder Rebuild Kit</b> 37.910001 '86-99 37.910002 '00-02				
				<b>Rear Master Cylinder Rebuild Kit</b> 37.910007 '92-02				

**DIRT**  
 APRILIA  
 BETA  
 BMW  
 GAS GAS  
**HONDA**  
 HUSABERG  
 HUSQVARNA  
 KAWASAKI  
 KTM  
 MOTO TM  
 RIEJU  
 SHERCO  
 SUZUKI  
 YAMAHA

**STREET**  
 APRILIA  
 CAGIVA  
 HONDA  
 KAWASAKI  
 KTM  
 SUZUKI  
 YAMAHA

**ATV-UTV**  
 CAN-AM  
 GAS GAS  
 HONDA  
 KAWASAKI  
 KTM  
 POLARIS  
 SUZUKI  
 YAMAHA

**PWC**  
 KAWASAKI  
 POLARIS  
 SEA DOO  
 YAMAHA

**SNOW**  
 ARCTIC CAT  
 KAWASAKI  
 LYNX  
 MOTO-SKI  
 POLARIS  
 SKI DOO  
 YAMAHA

**MOPED & SCOOTER**

**MISC. TECH. SPECIAL**



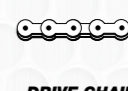

**HONDA**

**DIRT**  
APRILIA  
BETA  
BMW  
GAS GAS  
HONDA  
HUSABERG  
HUSQVARNA  
KAWASAKI  
KTM  
MOTO TM  
RIEJU  
SHERCO  
SUZUKI  
YAMAHA

XR 100 R 4-Stroke	Piston Kit -	Size 53.00	Ring Set -			Ignition Cover Gasket 19.G91104 '85-03	Valve Seal 35.VS001 '81-03 1x Intake 35.VS001 '81-03 1x Exhaust
----------------------	-----------------	---------------	---------------	--	--	---	---

**STREET**  
APRILIA  
CAGIVA  
HONDA  
KAWASAKI  
KTM  
SUZUKI  
YAMAHA

CRF 100 F 4-Stroke	Piston Kit -	Size 53.00	Ring Set -			Ignition Cover Gasket 19.G91104 '04-13	Valve Seal 35.VS001 '04-13 1x Intake 35.VS001 '04-13 1x Exhaust
-----------------------	-----------------	---------------	---------------	--	--	---	---

**ATV-UTV**  
CAN-AM  
GAS GAS  
HONDA  
KAWASAKI  
KTM  
POLARIS  
SUZUKI  
YAMAHA

CRF 110 F 4-Stroke	Piston Kit -	Size 50.00	Ring Set -				Valve Seal 35.VS004 '13-23 1x Intake 35.VS004 '13-23 1x Exhaust
-----------------------	-----------------	---------------	---------------	--	--	--	---

**PWC**  
KAWASAKI  
POLARIS  
SEA DOO  
YAMAHA

**SNOW**  
ARCTIC CAT  
KAWASAKI  
LYNX  
MOTO-SKI  
POLARIS  
SKI DOO  
YAMAHA

**MOPED & SCOOTER**

**MISC. TECH. SPECIAL**

Footnotes: \* Bearings Only \*\* Rubbers included

**DIRT**  
APRILIA  
BETA  
BMW  
GAS GAS  
HONDA  
HUSABERG  
HUSQVARNA  
KAWASAKI  
KTM  
MOTO TM  
RIEJU  
SHERCO  
SUZUKI  
YAMAHA

**STREET**  
APRILIA  
CAGIVA  
HONDA  
KAWASAKI  
KTM  
SUZUKI  
YAMAHA

**ATV-UTV**  
CAN-AM  
GAS GAS  
HONDA  
KAWASAKI  
KTM  
POLARIS  
SUZUKI  
YAMAHA

**PWC**  
KAWASAKI  
POLARIS  
SEA DOO  
YAMAHA

**SNOW**  
ARCTIC CAT  
KAWASAKI  
LYNX  
MOTO-SKI  
POLARIS  
SKI DOO  
YAMAHA

**MOPED & SCOOTER**

**MISC. TECH. SPECIAL**

Air Filter 52.11088 '88-03  Main Jet 45.393095-190 '95-03 Keihin  Pilot Jet 46.040-085 '95-03 Keihin  Throttle Cable 53.110004 '86-03	Clutch Cable 53.120005 '85-03	Friction Set 16.S11030 '81-86 16.S11031 '87-03	F/W Bearing 23.S110027 '85-03  R/W Bearing 23.S111091 '85-03  Steering Bearing 24.110002 '85-03			Chain 07.RC428130C '81-03 MX	Swingarm 26.210090 '85-03  Linkage 26.110091 '85-00 26.110090 '01-03  Lower 26.450017 '85-03
---	-------------------------------------	--	---	--	--	------------------------------------	--

Air Filter 52.11088 '04-13  Main Jet 45.393095-190 '04-13 Keihin  Pilot Jet 46.040-085 '04-13 Keihin  Throttle Cable 53.110004 '04-13	Clutch Cable 53.120005 '04-13	Friction Set 16.S11031 '04-13	F/W Bearing 23.S110027 '04-13  R/W Bearing 23.S111091 '04-13  Steering Bearing 24.110002 '04-13			Chain 07.RC428130C '04-13 MX	Swingarm 26.210090 '04-13  Linkage 26.110090 '04-13  Lower 26.450017 '04-13
---	-------------------------------------	-------------------------------------	---	--	--	------------------------------------	---

			F/W Bearing 23.S110027 '13-23  R/W Bearing 23.S111091 '13-23  Steering Bearing 24.110029 '13-18 24.110021 '19-23			Chain 07.RC420130C '13-23 MX	
--	--	--	--	--	--	------------------------------------	--

**DIRT**  
APRILIA  
BETA  
BMW  
GAS GAS  
HONDA  
HUSABERG  
HUSQVARNA  
KAWASAKI  
KTM  
MOTO TM  
RIEJU  
SHERCO  
SUZUKI  
YAMAHA

**STREET**  
APRILIA  
CAGIVA  
HONDA  
KAWASAKI  
KTM  
SUZUKI  
YAMAHA

**ATV-UTV**  
CAN-AM  
GAS GAS  
HONDA  
KAWASAKI  
KTM  
POLARIS  
SUZUKI  
YAMAHA

**PWC**  
KAWASAKI  
POLARIS  
SEA DOO  
YAMAHA

**SNOW**  
ARCTIC CAT  
KAWASAKI  
LYNX  
MOTO-SKI  
POLARIS  
SKI DOO  
YAMAHA

**MOPED & SCOOTER**

**MISC. TECH. SPECIAL**



**HONDA**

**DIRT**  
 APRILIA  
 BETA  
 BMW  
 GAS GAS  
 HONDA  
 HUSABERG  
 HUSQVARNA  
 KAWASAKI  
 KTM  
 MOTO TM  
 RIEJU  
 SHERCO  
 SUZUKI  
 YAMAHA

**STREET**  
 APRILIA  
 CAGIVA  
 HONDA  
 KAWASAKI  
 KTM  
 SUZUKI  
 YAMAHA

**ATV-UTV**  
 CAN-AM  
 GAS GAS  
 HONDA  
 KAWASAKI  
 KTM  
 POLARIS  
 SUZUKI  
 YAMAHA

**PWC**  
 KAWASAKI  
 POLARIS  
 SEA DOO  
 YAMAHA

**SNOW**  
 ARCTIC CAT  
 KAWASAKI  
 LYNX  
 MOTO-SKI  
 POLARIS  
 SKI DOO  
 YAMAHA

**MOPED & SCOOTER**

**MISC. TECH. SPECIAL**

CR 125 2-Stroke	Piston Kit	Size (mm)	Ring Set	CrankBearing & Seal Kit	Con. Rod Kit	Complete
	01.1204.025 '85-86	54.00 54.25	02.1208 -	23.CBS12080 '80-85	03.1212 '88-07	34.1212 '90-97
	01.1205.175 '87	55.75	- '87	23.CBS12086 '86-07	S/E Bearing 21.1205 '79-87	34.1218 '98-99
	01.1208.A 01.1208.A1 01.1208.A2 01.1208.A3 '88-91	53.93 53.94 53.95 53.96	02.1208 02.1208 02.1208 02.1208 '88-91	Bearing 23.6322C4 '80-07 2x	21.1211 '89-07	34.1220 '00-02 34.1223 '03
	01.1218.A1 01.1218.A2 01.1218.A3 01.1218.A4 '92-03	53.94 53.95 53.96 53.97	02.1213 02.1213 02.1213 02.1213 '92-03	Oilseal Set 42.1202 '80-85 42.1206 '86-07	B/E Bearing 22.222816 '83-87 22.222916F '88-07	34.1224 '04 34.1225 '05-07
	01.1222.A 01.1222.B 01.1222.C 01.1222.D '04	53.94 53.95 53.96 53.97	02.1222 02.1222 02.1222 02.1222 '04	Crankpin 06.2254 '85-07		Top-End 35.1207 '88-89 35.1210 '90-97 35.1218 '98-99 35.1220 '00-02 35.1223 '03 35.1224 '04
	01.1225.A 01.1225.B 01.1225.C 01.1225.D '05-07	53.94 53.95 53.96 53.97	02.1225 02.1225 02.1225 02.1225 '05-07			Head & Base 36.1200 '00-02 36.1203 '03 36.1204 '04 36.1205 '05-07
						Ignition Cover Gasket 19.G91287 '87-00 19.G91201 '01-04 19.G91205 '05-07

Footnotes: \* Bearings Only \*\* Rubbers included

Air Filter	Basket	Complete Plate Set	F/W Bearing	Frontbrake Disc	Front Sprocket	Chain	Swingarm	Seal & Wiper
52.12089 '89-01 52.12002 '02-07	17.1287F * '87-99 17.1220F * '00-07	16.CPS12086 '86-89 16.CPS12090 '90-99 16.CPS12000 '00-07	23.S110075 '85-94 23.S110081 '95-07	37.BD11295 '95-07	07.FS12087-12 07.FS12087-13 07.FS12087-14 '87-03	07.RC520120C '79-07 MX 07.RC520120CG '79-07 MX Gold 07.RC520120XC '79-07 X-Ring 07.RC520120XCG '79-07 X-Ring Gold	26.210141 '79-80 26.210142 '82-84 26.210013 '85 26.210014 '86 26.210013 '87-88	40.S435411 '86-89 40.S455711 '90-91 40.S43559 '92-96 40.S46589 '97-07
Main Jet 45.100-225 '79-99 Keihin 47.090-580 '00-07 Mikuni	Clutch Rubber Set 17.CRS1287-8 '87-07	Friction Set 16.S13033 '83-84 16.S12085 '85-89 16.S12004 '90-99 16.S12006 '00-07	R/W Bearing 23.S111013 '82 23.S111015 '83-86 23.S112041 '87-88 23.S112004 '89 23.S112002 '90-99 23.S112050 '00-07	Rearbrake Disc 37.BD21289 '89-01 37.BD21202 '02-07	7075-T6 Alloy Rear Sprocket 07.RA12087-48 07.RA12087-49 07.RA12087-50 07.RA12087-51 07.RA12087-52 '87-07	Countershaft Seal Kit 26.640010 '86-03 26.640009 '04-07	26.210029 '90 26.210030 '91-92 26.210041 '93-01 26.210040 '02-07	Oil Seal Set 40.F455711P '90-91 40.F43559 '92-96 40.F46589 '97-07
Pilot Jet 46.040-085 '95-99 Keihin 49.010-045 '00-07 Mikuni	Inner Hub 18.1290 '86-99 18.1337 '00-07	Steel Set 16.S12185 '83-84 16.S12090 '86-97 16.S12000 '00-07	F/W Spacer Kit 26.710013 '88-94 26.710004 '96-01 26.710005 '02-07	Front Pad Set 37.208002 '84-86 37.208002BX '84-86 Box of 10 37.105302 '87-94 37.105302BX '87-94 Box of 10 37.103202 '95-07	7075-T6 Alloy Rear Sprocket 07.RS12087R-48 07.RS12087R-49 07.RS12087R-50 07.RS12087R-51 07.RS12087R-52 '87-07	Lower Chain Roller 33.0002 '81 33.0008 '82 33.0006 '83-84 33.0008 '85-96 33.0011 '87 33.0007 '99 33.0008 '00-04 33.0007 '05-07	Dust Seal Set 40.F4354DP '86-89 40.F4557DP '90-91 40.F4355DP '92-96 40.F4658D '97-07	
Carburetor Rebuild Kit 55.10544 '90-95 55.10543 '96-97 55.10188 '98 55.10186 '99 55.10185 '00 55.10184 '01 55.10183 '02 55.10182 '03 55.10181 '04 55.10180 '05-07	Pressure Plate 18.P1286 '86-99 18.P1308 '00-07	Spring Kit 17.CS12002 '86-99 17.CS12003 '00-07	R/W Spacer Kit 26.710013 '88-94 26.710014 '95-99 26.710015 '00-07	Rear Pad Set 37.207102 '87-01 37.207102BX '87-01 Box of 10 37.208202 '02-07 37.208202BX '02-07 Box of 10	Ultralight Steel Rear Sprocket 07.RS12087R-48 07.RS12087R-49 07.RS12087R-50 07.RS12087R-51 07.RS12087R-52 '87-07	Upper Chain Roller 33.0002 '81 33.0006 '82-92 33.0008 '93-99 33.0007 '00-07	Bushing Set 39.160085 '87 39.160005 '88-89 39.160006 '90-91 39.160009 '94-96 39.160010 '97-07	
Throttle Cable 53.110005 '84 53.112001 '85-89 53.112000 '90-92 53.110005 '93-99 53.110006 '00-03 53.110007 '04-07	Cover Gasket 19.G1287 '87-07	Clutch Cable 53.120008 '87-97 53.120009 '98-99 53.120008 '00-03 53.120007 '04-07	Steering Bearing 24.110021 '82-89 24.110018 '90-92 24.110010 '93-94 24.110030 '95-97 24.110010 '98-07	Front Caliper Rebuild Kit 37.63004 '84-86 37.63005 '87-07	Sprocket Bolt Set 07.SBSM825 '87-07	Rear Sprocket Seal Head Kit 33.0007 '99 33.0008 '00-04 33.0007 '05-07	Rear Shock 26.810007 '81 26.810010 '84-86 26.810007 '87-92 26.810004 '93-07	
Water Pump Rebuild Kit 57.1214 '84-86 57.1217 '87-89 57.1219 '90-04 57.1225 '05-07				Rear Master Cylinder Rebuild Kit 37.910001 '84-98 37.910002 '99-07		Front Master Cylinder Rebuild Kit 37.910007 '87-01 37.910008 '02-07	Lower 26.310017 '85-88 26.450029 '89-90 26.450006 '91-93 26.450004 '94-95 26.450005 '96 26.450008 '97-07	

**DIRT**  
 APRILIA  
 BETA  
 BMW  
 GAS GAS  
 HONDA  
 HUSABERG  
 HUSQVARNA  
 KAWASAKI  
 KTM  
 MOTO TM  
 RIEJU  
 SHERCO  
 SUZUKI  
 YAMAHA

**STREET**  
 APRILIA  
 CAGIVA  
 HONDA  
 KAWASAKI  
 KTM  
 SUZUKI  
 YAMAHA

**ATV-UTV**  
 CAN-AM  
 GAS GAS  
 HONDA  
 KAWASAKI  
 KTM  
 POLARIS  
 SUZUKI  
 YAMAHA

**PWC**  
 KAWASAKI  
 POLARIS  
 SEA DOO  
 YAMAHA

**SNOW**  
 ARCTIC CAT  
 KAWASAKI  
 LYNX  
 MOTO-SKI  
 POLARIS  
 SKI DOO  
 YAMAHA

**MOPED & SCOOTER**

**MISC. TECH. SPECIAL**

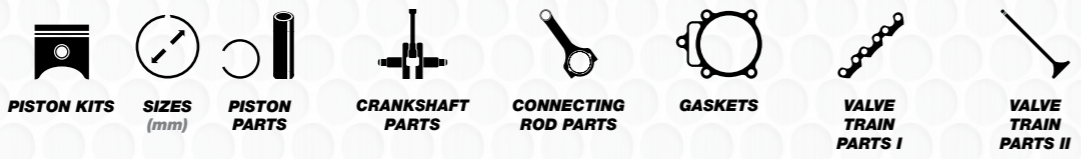

**HONDA**

<b>DIRT</b> APRILIA BETA BMW GAS GAS HONDA HUSABERG HUSQVARNA KAWASAKI KTM MOTO TM RIEJU SHERCO SUZUKI YAMAHA	XL 125 4-Stroke	<b>Piston Kit</b> 01.1175.000 01.1175.025 01.1175.050 01.1175.075 01.1175.100 '77-83	<b>Size (mm)</b> 56.50 56.75 57.00 57.25 57.50	<b>Ring Set</b> - - - 02.1175.100 '77-83  <b>Clips</b> 05.1510	<b>Con. Rod Kit</b> 03.1255					
	XL 125 S 4-Stroke	<b>Piston Kit</b> 01.1176.000	<b>Size</b> 56.50	<b>Ring Set</b> -  <b>Clips</b> 05.1510	<b>Con. Rod Kit</b> 03.1253  <b>B/E Bearing</b> 22.303816					
<b>STREET</b> APRILIA CAGIVA HONDA KAWASAKI KTM SUZUKI YAMAHA	MTX 125 2-Stroke Please Note: Nikasil Piston Size	<b>Piston Kit</b> 01.1200.D	<b>Size</b> 55.99	<b>Ring Set</b> -  <b>Pin</b> 04.1647  <b>Clips</b> 05.1612C	<b>S/E Bearing</b> 21.2250  <b>B/E Bearing</b> 22.222816					
	CRF 125 F 4-Stroke -Std. Compression 9.0:1	<b>Piston Kit</b> -	<b>Size</b> 52.40	<b>Ring Set</b> -			<b>Valve Seal</b> 35.VS003 '14-23 1x Intake 35.VS003 '14-23 1x Exhaust			
<b>ATV-UTV</b> CAN-AM GAS GAS HONDA KAWASAKI KTM POLARIS SUZUKI YAMAHA	CRF 150 F 4-Stroke -Std. Compression 9.5:1	<b>Piston Kit</b> -	<b>Size</b> 57.30	<b>Ring Set</b> -		<b>Top-End</b> 35.1233 '03-05 35.1236 '06-17  <b>Ignition Cover Gasket</b> 19.G91333 '03-05 19.G91236 '06-17	<b>Cam Chain</b> 31.1223 '03-05	<b>Valve</b> 28.1323-1 '03-05 1x Exhaust Steel 28.1226-1 '06-17 1x Exhaust Steel 28.1323-2 '03-05 1x Intake Steel 28.1226-2 '06-17 1x Intake Steel	<b>Valve Seal</b> 35.VS001 '03-05 1x Intake 35.VS001 '03-05 1x Exhaust 35.VS003 '06-17 1x Intake 35.VS003 '06-17 1x Exhaust	

Footnotes: \* Bearings Only \*\* Rubbers included

	<b>Clutch Cable</b> 53.120010 '79-84		<b>Steering Bearing</b> 24.110002 '74-85						<b>Swingarm</b> 26.210146 '79-85	

<b>DIRT</b> APRILIA BETA BMW GAS GAS HONDA HUSABERG HUSQVARNA KAWASAKI KTM MOTO TM RIEJU SHERCO SUZUKI YAMAHA										
<b>STREET</b> APRILIA CAGIVA HONDA KAWASAKI KTM SUZUKI YAMAHA										
<b>ATV-UTV</b> CAN-AM GAS GAS HONDA KAWASAKI KTM POLARIS SUZUKI YAMAHA										
<b>PWC</b> KAWASAKI POLARIS SEA DOO YAMAHA										
<b>SNOW</b> ARCTIC CAT KAWASAKI LYNX MOTO-SKI POLARIS SKI DOO YAMAHA										
<b>MOPED &amp; SCOOTER</b>										
<b>MISC. TECH. SPECIAL</b>										



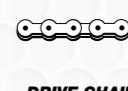

### HONDA

**DIRT**  
APRILIA  
BETA  
BMW  
GAS GAS  
HONDA  
HUSABERG  
HUSQVARNA  
KAWASAKI  
KTM  
MOTO TM  
RIEJU  
SHERCO  
SUZUKI  
YAMAHA

CRF 150 R 4-Stroke Please Note: Nikasil Piston Size -Std. Compression 11.7:1 -Forged Piston	<b>Piston Kit</b> 01.1227.A 01.1227.B 01.1227.C '07-09	<b>Size</b> 65.97 65.98 65.99	<b>Ring Set</b> 02.1227 02.1227 02.1227 '07-22	<b>Crank Bearing &amp; Seal Kit</b> 23.CBS12007 '07-23	<b>Con. Rod Kit</b> 03.1227 '07-23	<b>Complete</b> 34.1227 '07-23	<b>Cam Chain</b> 31.1227 '07-23	<b>Valve</b> 28.1227-1 '07-23 2x Exh. Steel 28.1227-2 '07-23 2x Int. Steel
Please Note: Nikasil Piston Size -Std. Compression 11.7:1 -Forged Piston	01.1232.A 01.1232.B 01.1232.C '12-23	65.97 65.98 65.99	02.1227 02.1227 02.1227 '12-23	<b>Bearing</b> 23.8ENK/60 '07-23 Left 23.SX04B10 '07-23 Right	<b>B/E Bearing</b> 22.253216F '07-23	<b>Top-End</b> 35.1227 '07-23	<b>Valve Shim Assortment</b> 29.VSA748 '07-23	<b>Valve Seal</b> 35.VS002 '07-23 4x
Please Note: Nikasil Piston Size -High Compression 12.2:1 -Forged Piston	<b>High Compression</b> 01.1228.A 01.1228.B '07-09	65.97 65.98	<b>Ring Set</b> 02.1227 02.1227 '07-09	<b>Oil Seal Set</b> 42.1207 '07-23	<b>Crankpin</b> 06.2550 '07-23	<b>Head &amp; Base</b> 36.1207 '07-23	<b>Valve Shim Assortment</b> 29.VSA748-2 '07-23	
				<b>Ignition Cover Gasket</b> 19.G91227 '07-21				
			<b>Pin</b> 04.1436.5 '07-23					
			<b>Clips</b> 05.1410C '07-23					

**STREET**  
APRILIA  
CAGIVA  
HONDA  
KAWASAKI  
KTM  
SUZUKI  
YAMAHA

XR 200 4-Stroke -Std. Compression 10.0:1 -Forged Piston	<b>Piston Kit</b> 01.1281.000 01.1281.050 01.1281.100 01.1281.150 '80-84	<b>Size</b> 65.50 66.00 66.50 67.00	<b>Ring Set</b> 02.1281.000 02.1281.050 02.1281.100 02.1281.150 '80-84		<b>Con. Rod Kit</b> 03.1253 '80-82 03.1255 '83-84			<b>Valve</b> 28.1381-1 '80-84 1x Exhaust Steel 28.1381-2 '80-84 1x Intake Steel
					<b>B/E Bearing</b> 22.303816 '80-82 22.303818C '83-84			<b>Valve Seal</b> 35.VS001 '80-84 2x

**PWC**  
KAWASAKI  
POLARIS  
SEA DOO  
YAMAHA

XR 200 R 4-Stroke -Std. Compression 10.0:1 -Forged Piston	<b>Piston Kit</b> 01.1281.000 01.1281.050 01.1281.100 01.1281.150 '81-83+'86-02	<b>Size</b> 65.50 66.00 66.50 67.00	<b>Ring Set</b> 02.1281.000 02.1281.050 02.1281.100 02.1281.150 '81-83+'86-02	<b>Bearing</b> 23.6228C3 '81-02 Right	<b>Con. Rod Kit</b> 03.1255 '81-83 + '86-02			<b>Valve</b> 28.1381-1 '81-83 + '86-02 2x Steel 28.1381-2 '81-83 + '86-02 2x Steel
					<b>B/E Bearing</b> 22.303818C '81-83 + '86-02			<b>Valve Seal</b> 35.VS001 '81-83 + '86-02 2x
			<b>Clips</b> 05.1510 '81-83+'86-02					

**SNOW**  
ARCTIC CAT  
KAWASAKI  
LYNX  
MOTO-SKI  
POLARIS  
SKI DOO  
YAMAHA

**MOPED & SCOOTER**

**MISC. TECH. SPECIAL**

Footnotes: \* Bearings Only \*\* Rubbers included

**DIRT**  
APRILIA  
BETA  
BMW  
GAS GAS  
HONDA  
HUSABERG  
HUSQVARNA  
KAWASAKI  
KTM  
MOTO TM  
RIEJU  
SHERCO  
SUZUKI  
YAMAHA

**STREET**  
APRILIA  
CAGIVA  
HONDA  
KAWASAKI  
KTM  
SUZUKI  
YAMAHA

**ATV-UTV**  
CAN-AM  
GAS GAS  
HONDA  
KAWASAKI  
KTM  
POLARIS  
SUZUKI  
YAMAHA

**PWC**  
KAWASAKI  
POLARIS  
SEA DOO  
YAMAHA

**SNOW**  
ARCTIC CAT  
KAWASAKI  
LYNX  
MOTO-SKI  
POLARIS  
SKI DOO  
YAMAHA

**MOPED & SCOOTER**

**MISC. TECH. SPECIAL**

<b>Air Filter</b> 52.12007 '07-23	<b>Basket</b> 17.1227F '07-09	<b>Complete Plate Set</b> 16.CPS12007 '07-23	<b>F/W Bearing</b> 23.S115039 '07-23	<b>Frontbrake Disc</b> 37.BD11196 '07-23	<b>Front Sprocket</b> 07.FS12007-14 07.FS12007-15 07.FS12007-16 '07-23	<b>Chain</b> 07.RC420130C '07-23 MX	<b>Swingarm</b> 26.210019 '07-23	<b>Seal &amp; Wiper</b> 40.S375011 '07-23
<b>Main Jet</b> 45.100-225 '07-23 Keihin	<b>Inner Hub</b> 18.1227 '07-23	<b>Friction Set</b> 16.S12023 '07-23	<b>R/W Bearing</b> 23.S115040 '07-23	<b>Rearbrake Disc</b> 37.BD21192 '07-23	<b>Lower Chain Roller</b> 33.0011 '07-23	<b>7075-T6 Alloy Rear Sprocket</b> 07.RA11086-50 07.RA11086-52 07.RA11086-53 07.RA11086-55 07.RA11086-56 '07-23	<b>Linkage</b> 26.110153 '07-23	<b>Oil Seal Set</b> 40.F375011 '07-23
<b>Pilot Jet</b> 46.040-085 '07-23 Keihin	<b>Pressure Plate</b> 18.P1227 '07-23	<b>Steel Set</b> 16.S12024 '07-23	<b>Steering Bearing</b> 24.110021 '07-23	<b>Front Pad Set</b> 37.200802 '07-23 37.200802BX '07-23 Box of 10	<b>Upper</b> 26.350055 '07-23		<b>Dust Seal Set</b> 40.F375011 '07-23	<b>Lower</b> 26.410023 '07-23
<b>Carburetor Rebuild Kit</b> 55.10474 '07 55.10001 '08-09 55.10500 '12-23	<b>Spring Kit</b> 17.CS12010 '07-23			<b>Rear Pad Set</b> 37.208202 '07-23 37.208202BX '07-23 Box of 10	<b>Sprocket Bolt Set</b> 07.SBSM825 '07-23		<b>Bushing Set</b> 39.160112 '07-22	<b>Rear Shock Seal Head Kit</b> 26.810006 '07-20
<b>Throttle Cable</b> 53.110009 '07-23	<b>Cover Gasket</b> 19.G1227 '07-21	<b>Clutch Cable</b> 53.120011 '07-23		<b>Front Caliper Rebuild Kit</b> 37.63002 '07-23				
<b>Oil Filter</b> 54.13116 '07-23 1-Pce. 54.13116-50 '07-23 50-Pcs.				<b>Rear Caliper Rebuild Kit</b> 37.63029 '07-23				
<b>Water Pump Rebuild Kit</b> 57.1227 '07-23				<b>Front Master Cylinder Rebuild Kit</b> 37.910002 '07-23				
				<b>Rear Master Cylinder Rebuild Kit</b> 37.910009 '07-23				

	<b>Clutch Cable</b> 53.120010 '80-84	<b>Friction Set</b> 16.S12032 '80-84	<b>Steering Bearing</b> 24.110002 '80-84		<b>Chain</b> 07.RC520120C '80-84 MX 07.RC520120CG '80-84 MX Gold 07.RC520120XC '80-84 X-Ring 07.RC520120XCG '80-84 X-Ring Gold			
--	--	--	--	--	--	--	--	--

<b>Air Filter</b> 52.12084 '84-02	<b>Clutch Cable</b> 53.120010 '81-83+'86-02	<b>Friction Set</b> 16.S12032 '81-02	<b>R/W Bearing</b> 23.S112014 '81-02		<b>7075-T6 Alloy Rear Sprocket</b> 07.RA22099-47 07.RA22099-48 07.RA22099-49 07.RA22099-50 07.RA22099-51 07.RA22099-52 '84-02	<b>Chain</b> 07.RC520120C '81-02 MX 07.RC520120CG '81-02 MX Gold 07.RC520120XC '81-02 X-Ring 07.RC520120XCG '81-02 X-Ring Gold	<b>Swingarm</b> 26.210021 '88-02	<b>Bushing Set</b> 39.160011 '85-02
<b>Throttle Cable</b> 53.112001 '81-83			<b>Steering Bearing</b> 24.110021 '81-02		<b>UltraLight Steel Rear Sprocket</b> 07.RS22099R-47 07.RS22099R-48 07.RS22099R-49 07.RS22099R-50 07.RS22099R-51 07.RS22099R-52 '84-02		<b>Linkage</b> 26.110028 '90-02	<b>Rear Shock Seal Head Kit</b> 26.810010 '84-02
					<b>Sprocket Bolt Set</b> 07.SBSM825 '84-02		<b>Upper</b> 26.310017 '81-91	

**DIRT**  
APRILIA  
BETA  
BMW  
GAS GAS  
HONDA  
HUSABERG  
HUSQVARNA  
KAWASAKI  
KTM  
MOTO TM  
RIEJU  
SHERCO  
SUZUKI  
YAMAHA

**STREET**  
APRILIA  
CAGIVA  
HONDA  
KAWASAKI  
KTM  
SUZUKI  
YAMAHA

**ATV-UTV**  
CAN-AM  
GAS GAS  
HONDA  
KAWASAKI  
KTM  
POLARIS  
SUZUKI  
YAMAHA

**PWC**  
KAWASAKI  
POLARIS  
SEA DOO  
YAMAHA

**SNOW**  
ARCTIC CAT  
KAWASAKI  
LYNX  
MOTO-SKI  
POLARIS  
SKI DOO  
YAMAHA

**MOPED & SCOOTER**

**MISC. TECH. SPECIAL**

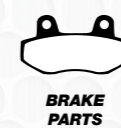

### HONDA

DIRT	CRF 230 F 4-Stroke -Std. Compression 9.0:1	Piston Kit 01.1363.000 01.1363.050 01.1363.100 01.1363.200 '03-19	Size 65.50 66.00 66.50 67.50	Ring Set 02.1363.000 02.1363.050 02.1363.100 02.1363.200 '03-19	Con. Rod Kit 03.1363 '03-19	Complete 34.1333 '03-19	Cam Chain 31.1323 '03-19	Valve 28.1323-1 '03-19 1x Exhaust Steel 28.1323-2 '03-19 1x Intake Steel
APRILIA BETA BMW GAS GAS HONDA HUSABERG HUSQVARNA KAWASAKI KTM MOTO TM RIEJU SHERCO SUZUKI YAMAHA								
STREET								
APRILIA CAGIVA HONDA KAWASAKI KTM SUZUKI YAMAHA								
ATV-UTV	CRF 230 L 4-Stroke -Std. Compression 9.0:1	Piston Kit 01.1363.000 01.1363.050 01.1363.100 01.1363.200 '08-09	Size 65.50 66.00 66.50 67.50	Ring Set 02.1363.000 02.1363.050 02.1363.100 02.1363.200 '08-09		Top-End 35.1333 '08-09	Cam Chain 31.1323 '08-09	Valve 28.1323-1 '08-09 1x Exhaust Steel 28.1323-2 '08-09 1x Intake Steel
CAN-AM GAS GAS HONDA KAWASAKI KTM POLARIS SUZUKI YAMAHA								
PWC								
KAWASAKI POLARIS SEA DOO YAMAHA								
SNOW								
ARCTIC CAT KAWASAKI LYNX MOTO-SKI POLARIS SKI DOO YAMAHA								
MOPED & SCOOTER								
MISC. TECH. SPECIAL								

Footnotes: \* Bearings Only \*\* Rubbers included

Air Filter 52.13003 '03-19	Clutch Cable 53.120013 '03-19	F/W Bearing 23.S114021 '03-19	Front Pad Set 37.103202 '03-19 37.103202BX '03-19 Box of 10	Front Sprocket 07.FS13003-12 07.FS13003-13 07.FS13003-14 '03-19	Chain 07.RC520120C '03-19 MX 07.RC520120CG '03-19 MX Gold 07.RC520120XC '03-19 X-Ring 07.RC520120XCG '03-19 X-Ring Gold	Swingarm 26.210099 '03-19	Seal & Wiper 40.S375011 '03-19
Main Jet 45.100-225 '03-19 Keihin		R/W Bearing 23.S114022 '03-19	Front Caliper Rebuild Kit 37.63005 '03-19	7075-T6 Alloy Rear Sprocket 07.RA12087-48 07.RA12087-49 07.RA12087-50 07.RA12087-51 07.RA12087-52 '03-19	Upper Chain Roller 33.0013 '03-19	Linkage 26.110098 '03-19	Oil Seal Set 40.F375011 '03-19
Pilot Jet 46.F025-F060 '08-19 Keihin		Steering Bearing 24.110021 '03-19	Front Master Cylinder Rebuild Kit 37.910004 '03-19	UltraLight Steel Rear Sprocket 07.RS12087R-48 07.RS12087R-49 07.RS12087R-50 07.RS12087R-51 07.RS12087R-52 '03-19		Lower 26.450019 '03-19	Dust Seal Set 40.F3750D '03-19
Carburetor Rebuild Kit 55.10173 '03-19				Sprocket Bolt Set 07.SBSM825 '03-19			
Throttle Cable 53.110012 '03-19							
		F/W Bearing 23.S110069 '08-09	Front Pad Set 37.103202 '08-09 37.103202BX '08-09 Box of 10	7075-T6 Alloy Rear Sprocket 07.RA12087-48 07.RA12087-49 07.RA12087-50 07.RA12087-51 07.RA12087-52 '08-09	Chain 07.RC520120C '08-09 MX 07.RC520120CG '08-09 MX Gold 07.RC520120XC '08-09 X-Ring 07.RC520120XCG '08-09 X-Ring Gold	Swingarm 26.210193 '08-09	Seal & Wiper 40.S375011 '08-09
		R/W Bearing 23.S112006 '08-09	Rear Pad Set 37.261002 '08-09	UltraLight Steel Rear Sprocket 07.RS12087R-48 07.RS12087R-49 07.RS12087R-50 07.RS12087R-51 07.RS12087R-52 '08-09		Linkage 26.110168 '08-09	Oil Seal Set 40.F375011 '08-09
		Steering Bearing 24.110021 '08-09	Front Caliper Rebuild Kit 37.63007 '08-09	Sprocket Bolt Set 07.SBSM825 '08-09		Lower 26.450019 '08-09	Dust Seal Set 40.F3750D '08-09
			Rear Caliper Rebuild Kit 37.63028 '08-09				
			Front Master Cylinder Rebuild Kit 37.910004 '08-09				

DIRT	APRILIA BETA BMW GAS GAS HONDA HUSABERG HUSQVARNA KAWASAKI KTM MOTO TM RIEJU SHERCO SUZUKI YAMAHA
STREET	APRILIA CAGIVA HONDA KAWASAKI KTM SUZUKI YAMAHA
ATV-UTV	CAN-AM GAS GAS HONDA KAWASAKI KTM POLARIS SUZUKI YAMAHA
PWC	KAWASAKI POLARIS SEA DOO YAMAHA
SNOW	ARCTIC CAT KAWASAKI LYNX MOTO-SKI POLARIS SKI DOO YAMAHA
MOPED & SCOOTER	
MISC. TECH. SPECIAL	



### HONDA

**DIRT**  
APRILIA  
BETA  
BMW  
GAS GAS  
HONDA  
HUSABERG  
HUSQVARNA  
KAWASAKI  
KTM  
MOTO TM  
RIEJU  
SHERCO  
SUZUKI  
YAMAHA

**STREET**  
APRILIA  
CAGIVA  
HONDA  
KAWASAKI  
KTM  
SUZUKI  
YAMAHA

**ATV-UTV**  
CAN-AM  
GAS GAS  
HONDA  
KAWASAKI  
KTM  
POLARIS  
SUZUKI  
YAMAHA

**PWC**  
KAWASAKI  
POLARIS  
SEA DOO  
YAMAHA

**SNOW**  
ARCTIC CAT  
KAWASAKI  
LYNX  
MOTO-SKI  
POLARIS  
SKI DOO  
YAMAHA

**MOPED & SCOOTER**

**MISC. TECH. SPECIAL**

CR 250 2-Stroke	Piston Kit	Size (mm)	Ring Set	Crank Bearing & Seal Kit	Con. Rod Kit	Complete			
	01.1309.000 01.1309.050 01.1309.100 01.1309.150 01.1309.200 '84-85	66.00 66.50 67.00 67.50 68.00	- - 02.1309.150 -	23.CBS13084 '84-91 23.CBS13092 '92-07	03.1315 '84-01 03.1322 '02-07 34.1325 '05-07	34.1312 '92-01 34.1322 '02-04 34.1325 '05-07			
Please Note: Nikasil Piston Size -Molycoated Skirt	01.1315.A 01.1315.A1 01.1315.A2 01.1315.A3 01.1315.A4 '86-96	66.34 66.35 66.36 66.37 66.38	02.1315 02.1315 02.1315 02.1315 02.1315 '86-96	23.6328C3 '78-07 2x	<b>S/E Bearing</b> 21.1303 '85 21.1316 '86-07	<b>Top-End</b> 35.1306 '86-87 35.1308 '88 35.1309 '89-91 42.1312 '92-07			
Please Note: Nikasil Piston Size -Molycoated Skirt	01.1320.A 01.1320.A1 01.1320.A2 01.1320.A3 '97-01	66.34 66.35 66.36 66.37	02.1315 02.1315 02.1315 02.1315 '97-01	<b>Oilseal Set</b> 42.1304 '84-91 42.1312 '92-07	<b>B/E Bearing</b> 22.243117F '84-01 22.253216.5F '02-07	35.1312 '92-01 35.1322 '02-04 35.1325 '05-07			
Please Note: Nikasil Piston Size -Molycoated Skirt	01.1323.A 01.1323.B 01.1323.C 01.1323.D '02-04	66.34 66.35 66.36 66.37	02.1315 02.1315 02.1315 02.1315 '02-04	<b>Crankpin</b> 06.2459.6 '84-01 06.2559.6 '02-07		<b>Head &amp; Base</b> 36.1392 '92-01 36.1305 '05-07			
Please Note: Nikasil Piston Size	01.1325.A 01.1325.A1 01.1325.A2 01.1325.A3 '05-07	66.34 66.35 66.36 66.37	02.1325 02.1325 02.1325 02.1325 '05-07			<b>Ignition Cover Gasket</b> 19.G91302 '02-07			
			<b>Pin</b> 04.1856 '84-07						
			<b>Clips</b> 05.1812 '84-07						

Footnotes: \* Bearings Only \*\* Rubbers included

Air Filter	Basket	Complete Plate Set	F/W Bearing	Frontbrake Disc	Front Sprocket	Chain	Swingarm	Seal & Wiper
52.12089 '88-01 52.12002 '02-07	17.1387 * '87-89 17.1386 * '90-91 17.1403F * '92-07	16.CPS13090 '90-93 16.CPS13086 '94-96 16.CPS13097 '97-07	23.S110075 '85-94 23.S110081 '95-07	37.BD11295 '95-07	07.FS13088-12 07.FS13088-13 07.FS13088-14 07.FS13088-15 '88-07	07.RC520120C '73-07 MX 07.RC520120CG '73-07 MX Gold 07.RC520120XC '73-07 X-Ring 07.RC520120XCG '73-07 X-Ring Gold	26.210013 '85 26.210014 '86 26.210013 '87 26.210030 '88-91 26.210039 '92-01 26.210037 '02-07	40.S435411 '85-88 40.S455711 '89-91 40.S43549 '92-94 40.S43559 '95 40.S46589 '96 40.S475810 '97-07
<b>Main Jet</b> 45.100-225 '78-00 Keihin 47.090-580 '01-07 Mikuni	<b>Clutch Rubber Set</b> 17.CRS1386-8 '97-07	<b>Friction Set</b> 16.S13008 '84-89 16.S13010 '90-07	<b>R/W Bearing</b> 23.S111015 '83-86 23.S112041 '87-88 23.S112003 '89 23.S112002 '90-99 23.S112050 '00-07	<b>Front Pad Set</b> 37.105302 '87-94 37.105302BX '87-94 Box of 10 37.103202 '95-07 37.103202BX '95-07 Box of 10	<b>7075-T6 Alloy Rear Sprocket</b> 07.RA12087-48 07.RA12087-49 07.RA12087-50 07.RA12087-51 07.RA12087-52 '88-07	<b>Countershaft Seal Kit</b> 26.640008 '88-07	<b>Linkage</b> 26.110016 '85-87 26.110026 '89-90 26.110019 '91 26.110054 '92-93 26.110029 '94-95 26.110033 '96	40.S435411 '85-88 40.F43549 '92-94 40.F43559 '95 40.F46589 '96 40.F475810 '97-07
<b>Pilot Jet</b> 46.040-085 '95-00 Keihin 49.010-045 '01-07 Mikuni	<b>Inner Hub</b> 18.1490 '90-91 18.1397 '92-07	<b>Alloy Set</b> 16.S13009 '84-89 16.S13011 '90-93 16.S13012 '94-07	<b>F/W Spacer Kit</b> 26.710004 '96-01 26.710005 '02-07	<b>Rear Pad Set</b> 37.207102 '87-01 37.207102BX '87-01 Box of 10 37.208202 '02-07 37.208202BX '02-07 Box of 10	<b>UltraLight Steel Rear Sprocket</b> 07.RS12087R-48 07.RS12087R-49 07.RS12087R-50 07.RS12087R-51 07.RS12087R-52 '88-07	<b>Lower Chain Roller</b> 33.0006 '83-84 33.0008 '85-01 33.0007 '02-04 33.0015 '05-07	26.110007 '97 26.110008 '98-99 26.110003 '00-01 26.110125 '02-07	40.F435411 '85-88 40.F43549 '92-94 40.F43559 '95 40.F46589 '96 40.F475810 '97-07
<b>Carburetor Rebuild Kit</b> 55.10170 '90-95 55.10547 '96 55.10546 '97-98 55.10167 '99 55.10166 '00 55.10413 '01 55.10165 '02 55.10164 '03 55.10163 '04 55.10162 '05-07	<b>Pressure Plate</b> 18.P1392 '92-07	<b>Spring Kit</b> 17.CS13005 '90-96 17.CS13006 '97-07	<b>R/W Spacer Kit</b> 26.710013 '88-94 26.710014 '95-99 26.710015 '00-07	<b>Steering Bearing</b> 24.110021 '82-89 24.110018 '90-91 24.110010 '92-94 24.110030 '95-96 24.110010 '97-07	<b>Sprocket Bolt Set</b> 07.SBSM825 '88-07	<b>Upper Chain Roller</b> 33.0006 '83-91 33.0008 '92-97 33.0006 '98 33.0007 '99-01 33.0008 '02-03 33.0010 '04-07	26.110007 '97 26.110008 '98-99 26.110003 '00-01 26.110125 '02-07	40.F4354DP '85-88 40.F4557DP '89-91 40.F4354DP '92-94 40.F4355DP '95 40.F4658D '96 40.F4758D '97-07
<b>Throttle Cable</b> 53.110005 '84 + '90-04 53.112001 '85 53.110017 '86-89 53.110005 '90-04 53.110006 '05-07	<b>Cover Gasket</b> 19.G1384 '84-01 19.G1302 '02-07	<b>Clutch Cable</b> 53.120052 '84-97 53.120015 '95-96 '98-07			<b>Front Caliper Rebuild Kit</b> 37.63004 '84-86 37.63004 '87-89 37.63005 '90-01 37.63005 '02-07	<b>Upper Chain Roller</b> 33.0006 '83-91 33.0008 '92-97 33.0006 '98 33.0007 '99-01 33.0008 '02-03 33.0010 '04-07	26.110007 '97 26.110008 '98-99 26.110003 '00-01 26.110125 '02-07	40.F4354DP '92-94 40.F4355DP '95 40.F4658D '96 40.F4758D '97-07
<b>Water Pump Rebuild Kit</b> 57.1319 '92-01 57.1322 '02-07					<b>Rear Caliper Rebuild Kit</b> 37.63028 '87-01 37.63029 '02-07	<b>Upper Chain Roller</b> 33.0006 '83-91 33.0008 '92-97 33.0006 '98 33.0007 '99-01 33.0008 '02-03 33.0010 '04-07	26.110007 '97 26.110008 '98-99 26.110003 '00-01 26.110125 '02-07	40.F4354DP '92-94 40.F4355DP '95 40.F4658D '96 40.F4758D '97-07
					<b>Front Master Cylinder Rebuild Kit</b> 37.910001 '84-98 37.910002 '90-01 '99-07	<b>Upper Chain Roller</b> 33.0006 '83-91 33.0008 '92-97 33.0006 '98 33.0007 '99-01 33.0008 '02-03 33.0010 '04-07	26.110007 '97 26.110008 '98-99 26.110003 '00-01 26.110125 '02-07	40.F4354DP '92-94 40.F4355DP '95 40.F4658D '96 40.F4758D '97-07
					<b>Rear Master Cylinder Rebuild Kit</b> 37.910007 '87-01 37.910008 '02-07	<b>Upper Chain Roller</b> 33.0006 '83-91 33.0008 '92-97 33.0006 '98 33.0007 '99-01 33.0008 '02-03 33.0010 '04-07	26.110007 '97 26.110008 '98-99 26.110003 '00-01 26.110125 '02-07	40.F4354DP '92-94 40.F4355DP '95 40.F4658D '96 40.F4758D '97-07

**DIRT**  
APRILIA  
BETA  
BMW  
GAS GAS  
HONDA  
HUSABERG  
HUSQVARNA  
KAWASAKI  
KTM  
MOTO TM  
RIEJU  
SHERCO  
SUZUKI  
YAMAHA

**STREET**  
APRILIA  
CAGIVA  
HONDA  
KAWASAKI  
KTM  
SUZUKI  
YAMAHA

**ATV-UTV**  
CAN-AM  
GAS GAS  
HONDA  
KAWASAKI  
KTM  
POLARIS  
SUZUKI  
YAMAHA

**PWC**  
KAWASAKI  
POLARIS  
SEA DOO  
YAMAHA

**SNOW**  
ARCTIC CAT  
KAWASAKI  
LYNX  
MOTO-SKI  
POLARIS  
SKI DOO  
YAMAHA

**MOPED & SCOOTER**

**MISC. TECH. SPECIAL**



### HONDA

**DIRT**  
APRILIA  
BETA  
BMW  
GAS GAS  
HONDA  
HUSABERG  
HUSQVARNA  
KAWASAKI  
KTM  
MOTO TM  
RIEJU  
SHERCO  
SUZUKI  
YAMAHA

CRF 250 R 4-Stroke Please Note: Nikasil Piston Size -Std. Compression 12.9:1	<b>Piston Kit</b> 01.1338.A 01.1338.B 01.1338.C '04-07	<b>Size</b> 77.97 77.98 77.99	<b>Ring Set</b> 02.1335 02.1335 02.1335 '04-07	<b>Crank Bearing &amp; Seal Kit</b> 23.CBS13004 '04-05 23.CBS13006 '06-17	<b>Con. Rod Kit</b> 03.1334 '04-17 03.1348 '18-23 34.1340 '10-17	<b>Complete</b> 34.1334 '04-07 34.1338 '08-09 34.1340 '10-17	<b>Cam Chain</b> 31.1335 '04-09 31.1340 '10-17 31.1348 '18-23	<b>Valve</b> 28.1334-1 '04-07 2x Exhaust Steel 28.1334-2 '04-09 2x Intake Titanium 28.1338-1 '08-09 2x Exhaust Steel 28.1340-1 '10-15 2x Exhaust Steel 28.1340-2 '10-17 2x Intake Titanium 28.1346-1 '16-17 2x Exhaust Titanium 28.1348-2 '18-23 2x Intake Titanium 28.1348-1 '18-23 2x Exhaust Titanium
--	--	--	--	---	--	--	---	--

**STREET**  
APRILIA  
CAGIVA  
HONDA  
KAWASAKI  
KTM  
SUZUKI  
YAMAHA

Please Note: Nikasil Piston Size -Std. Compression 13.5:1 -Forged Piston -Fuel Injection	01.1339.A 01.1339.B 01.1339.C '08-09	77.97 77.98 77.99	02.1335 02.1335 02.1335 '08-09	<b>Bearing</b> 23.SX06C62 '04-17 Right 23.SX06C62V1 '18-23 Right 23.8ENK/16 '04-17 Left	<b>B/E Bearing</b> 22.303818F '04-17 22.303820F '18-23	<b>Top-End</b> 35.1334 '04-07 35.1338 '08-09 35.1340 '10-17 35.1348 '18-21 35.1352 '22-23	<b>Valve Shim Assortment</b> 29.VSA748 '04-17 29.VSA748-2 '04-17 29.VSA948 '18-23 29.VSA948-2 '18-23	
--	---	-------------------------	---	---	--	---	--	--

**ATV-UTV**  
CAN-AM  
GAS GAS  
HONDA  
KAWASAKI  
KTM  
POLARIS  
SUZUKI  
YAMAHA

Please Note: Nikasil Piston Size -Std. Compression 13.9:1 -Forged Piston -Fuel Injection	01.1342.A 01.1342.B 01.1342.C '10-13	76.77 76.78 76.79	02.1342 02.1342 02.1342 '10-13	<b>Oilseal Set</b> 42.1402 '04-05 42.1405 '06-17 42.1348 '18	<b>Washers</b> 03W.30501.0 '04-23 2x	<b>Head &amp; Base</b> 36.1304 '04-09 36.1310 '10-17 36.1348 '18-21 36.1352 '22-23	<b>TI-Steel Conversion Set</b> 28.SIS1336-2 '04-07 Intake 28.SIS1337-2 '08-09 Intake 28.SIS1340-2 '10-17 Intake	<b>Valve Seal</b> 35.VS003 '04-07 4x 35.VS003 '08-15 2x Intake 35.VS002 '08-15 2x Exhaust 35.VS003 '16-21 4x 35.VS004 '22-23 4x
--	---	-------------------------	---	--	--	--	---	---

**PWC**  
KAWASAKI  
POLARIS  
SEA DOO  
YAMAHA

Please Note: Nikasil Piston Size -High Compression 13.5:1 -Forged Piston	01.1343.A 01.1343.B 01.1343.C '14-15	76.77 76.78 76.79	02.1342 02.1342 02.1342 '14-15					
---	---	-------------------------	---	--	--	--	--	--

**SNOW**  
ARCTIC CAT  
KAWASAKI  
LYNX  
MOTO-SKI  
POLARIS  
SKI DOO  
YAMAHA

Please Note: Nikasil Piston Size -High Compression 14.2:1 -Forged Piston -Fuel Injection	01.1344.A 01.1341.B '10-13	76.77 76.78	02.1340 02.1340 '10-13	<b>Pin</b> 04.1641.5 '04-09	<b>Clips</b> 05.1612C '04-17 05.1610 '18-23			
--	----------------------------------	----------------	------------------------------	-----------------------------------	---	--	--	--

**MOPED & SCOOTER**

Please Note: Nikasil Piston Size -Std. Compression 13.2:1 -Forged Piston -Fuel Injection	01.1342.A 01.1342.B 01.1342.C '10-13	76.77 76.78 76.79	02.1342 02.1342 02.1342 '10-13					
--	---	-------------------------	---	--	--	--	--	--

**MISC. TECH. SPECIAL**

Please Note: Nikasil Piston Size -Std. Compression 13.5:1 -Forged Piston -Fuel Injection	01.1343.A 01.1343.B 01.1343.C '16-17	76.77 76.78 76.79	02.1340 02.1340 02.1340 '16-17					
--	---	-------------------------	---	--	--	--	--	--

Footnotes: \* Bearings Only \*\* Rubbers included

<b>Air Filter</b> 52.14004 '04-09 52.13010 '10-13 52.14013 '14-17 52.14017 '18-19 52.13020 '20-21 52.14021 '22-23	<b>Basket</b> 17.1220F * '04-09 17.1340F '10-17	<b>Complete Plate Set</b> 16.CPS13004 '04-07 16.CPS13008 '08-09 16.CPS13010 '10 16.CPS13011 '11-13 16.CPS13014 '14-17 16.CPS13018 '18-19 16.CPS13022 '22-23	<b>F/W Bearing</b> 23.S110081 '04-23	<b>Frontbrake Disc</b> 37.BD11295 '04-14 37.BD11315 '15-23	<b>Front Sprocket</b> 07.FS12004-12 07.FS12004-13 07.FS12004-14 '04-17 07.FS13018-12 07.FS13018-13 07.FS13018-14 '18-21 07.FS13088-12 07.FS13088-13 07.FS13088-14 07.FS13088-15 '22-23	<b>Chain</b> 07.RC520120C '04-23 MX 07.RC520120CG '04-23 MX Gold 07.RC520120XC '04-23 X-Ring 07.RC520120XCG '04-23 X-Ring Gold	<b>Swingarm</b> 26.210127 '04-09 26.210128 '10-13 26.210206 '14-17 26.210218 '18-19 26.210222 '20-23	<b>Seal &amp; Wiper</b> 40.S475810 '04-09 40.S485810 '10-14 40.S496011 '15-23
---	---	---	--	--	---	--	--	---

<b>Main Jet</b> 45.100-225 '04-09 Keihin	<b>Clutch Rubber Set</b> 17.CRS1287-8 '04-17	<b>Inner Hub</b> 18.1337 '04-09 18.1340 '10-17 18.1348 '18-21	<b>F/W Spacer Kit</b> 26.710005 '04-23	<b>Front Pad Set</b> 37.103202 '04-23 37.103202BX '04-23 Box of 10	<b>Rear Pad Set</b> 37.208202 '04-23 37.208202BX '04-23 Box of 10	<b>Countershaft Seal Kit</b> 26.640009 '04-17 26.640008 '18-23	<b>7075-T6 Alloy Rear Sprocket</b> 07.RA12087-48 07.RA12087-49 07.RA12087-50 07.RA12087-51 07.RA12087-52 '04-23	<b>Lower Chain Roller</b> 33.0007 '04 33.0015 '05-09 33.0014 '10-11 33.0015 '12-13 33.0014 '14-15 33.0015 '18-23	<b>Linkage</b> 26.110125 '04-09 26.110172 '10-17 26.110186 '18-23	<b>Dust Seal Set</b> 40.F4758D '04-09 40.F4858D '10-14 40.F4960D '15-23
--	--	---	--	--	---	--	---	--	---	---

<b>Pilot Jet</b> 46.400-085 '04-09 Keihin	<b>Pressure Plate</b> 18.P1308 '04-09 18.P1340 '10-17 18.P1308 '22-23	<b>Spring Kit</b> 17.CS13004 '04-09 17.CS13050 '10-13 17.CS33052 '14-19 17.CS33052 '22-23	<b>Steering Bearing</b> 24.110010 '04-09 24.110059 '10-13 24.110065 '14-17 24.110010 '18-23	<b>Rear Caliper Rebuild Kit</b> 37.63005 '04-23	<b>Rear Caliper Rebuild Kit</b> 37.63029 '04-23	<b>Upper Chain Roller</b> 33.0007 '04-09 33.0014 '10-13 33.0014 '15-17 33.0015 '18-23	<b>Bushing Set</b> 39.160020 '04-08 39.160080 '09 39.160081 '10-14 39.160119 '15-17
---	---	---	---	---	---	---	---

<b>Carburetor Rebuild Kit</b> 55.10328 '04 55.10006 '05 55.10087 '06 55.10141 '07 55.10442 '08 55.10235 '09	<b>Cover Gasket</b> 19.G1334 '04-09 19.G1340 '10-17	<b>Clutch Cable</b> 53.120017 '04-07 53.120016 '08-09 53.121000 '10-13 53.120134 '14-17 53.121043 '18-21 53.121054 '22-23	<b>Oil Filter</b> 54.13116 '04-23 1-Pce. 54.13116-50 '04-23 50-Pcs.	<b>Water Pump Rebuild Kit</b> 57.1324 '04-09 57.1321 '10-17	<b>Oil Filter</b> 54.13116 '04-23 1-Pce. 54.13116-50 '04-23 50-Pcs.	<b>Water Pump Rebuild Kit</b> 57.1324 '04-09 57.1321 '10-17
---	---	---	---	---	---	---

<b>Throttle Cable</b> 53.110018 '04-09 53.110019 '10-13 53.110249 '14-15 53.112063 '16-17 53.112064 '18-21 53.112085 '22-23	<b>Cover Gasket</b> 19.G1334 '04-09 19.G1340 '10-17	<b>Clutch Cable</b> 53.120017 '04-07 53.120016 '08-09 53.121000 '10-13 53.120134 '14-17 53.121043 '18-21 53.121054 '22-23	<b>Oil Filter</b> 54.13116 '04-23 1-Pce. 54.13116-50 '04-23 50-Pcs.	<b>Water Pump Rebuild Kit</b> 57.1324 '04-09 57.1321 '10-17	<b>Oil Filter</b> 54.13116 '04-23 1-Pce. 54.13116-50 '04-23 50-Pcs.	<b>Water Pump Rebuild Kit</b> 57.1324 '04-09 57.1321 '10-17
---	---	---	---	---	---	---

**DIRT**  
APRILIA  
BETA  
BMW  
GAS GAS  
HONDA  
HUSABERG  
HUSQVARNA  
KAWASAKI  
KTM  
MOTO TM  
RIEJU  
SHERCO  
SUZUKI  
YAMAHA

**STREET**  
APRILIA  
CAGIVA  
HONDA  
KAWASAKI  
KTM  
SUZUKI  
YAMAHA

**ATV-UTV**  
CAN-AM  
GAS GAS  
HONDA  
KAWASAKI  
KTM  
POLARIS  
SUZUKI  
YAMAHA

**PWC**  
KAWASAKI  
POLARIS  
SEA DOO  
YAMAHA

**SNOW**  
ARCTIC CAT  
KAWASAKI  
LYNX  
MOTO-SKI  
POLARIS  
SKI DOO  
YAMAHA

**MOPED & SCOOTER**

**MISC. TECH. SPECIAL**



### HONDA

**DIRT**  
APRILIA  
BETA  
BMW  
GAS GAS  
HONDA  
HUSABERG  
HUSQVARNA  
KAWASAKI  
KTM  
MOTO TM  
RIEJU  
SHERCO  
SUZUKI  
YAMAHA

CRF 250 RX 4-Stroke Please Note: Nikasil Piston Size -Std. Compression 13.9:1	<b>Piston Kit</b> 01.1348.A 01.1348.B 01.1348.C '19	<b>Size</b> 78.97 78.98 78.99	<b>Ring Set</b> 02.1348 02.1348 02.1348 '19-23	<b>CrankBearing</b> 23.SX06C62V1 '19-23 Right	<b>Con. Rod Kit</b> 03.1348 '19-23	<b>Top-End</b> 35.1348 '19-21 35.1352 '22-23	<b>Cam Chain</b> 31.1348 '19-23	<b>Valve</b> 28.1348-2 '19-23 2x Intake Titanium 28.1348-1 '19-23 2x Exhaust Titanium
Please Note: Nikasil Piston Size -Std. Compression 13.9:1 -Forged Piston -Fuel Injection	01.1350.A 01.1350.B 01.1350.C '20-23	78.97 78.98 78.99	02.1348 02.1348 02.1348 '19-23		<b>B/E Bearing</b> 22.303820F '19-23	<b>Head &amp; Base</b> 36.1348 '19-21 36.1352 '22-23	<b>Valve Shim Assortment</b> 29.VSA948 '19-23 29.VSA948-2 '19-23	<b>Valve Seal</b> 35.VS003 '19-21 4x 35.VS004 '22-23 4x
			<b>Clips</b> 05.1610 '19-23		<b>Washers</b> 03W.30501.0 '19-23 2x			

**STREET**  
APRILIA  
CAGIVA  
HONDA  
KAWASAKI  
KTM  
SUZUKI  
YAMAHA

CRF 250 X 4-Stroke Please Note: Nikasil Piston Size -Std. Compression 12.9:1 -Forged Piston	<b>Piston Kit</b> 01.1338.A 01.1338.B 01.1338.C '04-17	<b>Size</b> 77.97 77.98 77.99	<b>Ring Set</b> 02.1335 02.1335 02.1335 '04-17	<b>CrankBearing &amp; Seal Kit</b> 23.CBS13004 '04-06 23.CBS13006 '07-17	<b>Con. Rod Kit</b> 03.1334 '04-17	<b>Complete</b> 34.1334 '04-17	<b>Cam Chain</b> 31.1335 '04-17	<b>Valve</b> 28.1334-1 '04-17 2x Exhaust Steel 28.1334-2 '04-17 2x Intake Titanium
Please Note: Nikasil Piston Size -High Compression 13.5:1 -Forged Piston	<b>High Comp.</b> 01.1339.A 01.1339.B 01.1339.C '04-17	77.97 77.98 77.99	02.1335 02.1335 02.1335 '04-17	<b>Bearing</b> 23.SX06C62 '04-17 Right 23.8ENK/16 '04-17 Left	<b>B/E Bearing</b> 22.303818F '04-17	<b>Top-End</b> 35.1334 '04-17	<b>Valve Shim Assortment</b> 29.VSA748 '04-17 29.VSA748-2 '04-17	<b>TI-Steel Conversion Set</b> 28.SIS1336-2 '04-17 Intake
			<b>Pin</b> 04.1641.5 '04-17	<b>Oilseal Set</b> 42.1402 '04-06 42.1405 '07-17		<b>Head &amp; Base</b> 36.1304 '04-17		<b>Valve Seal</b> 35.VS003 '04-17 2x Intake 35.VS003 '04-17 2x Exhaust

**PWC**  
KAWASAKI  
POLARIS  
SEA DOO  
YAMAHA

**SNOW**  
ARCTIC CAT  
KAWASAKI  
LYNX  
MOTO-SKI  
POLARIS  
SKI DOO  
YAMAHA

**MOPED & SCOOTER**

**MISC. TECH. SPECIAL**

Footnotes: \* Bearings Only \*\* Rubbers included

**DIRT**  
APRILIA  
BETA  
BMW  
GAS GAS  
HONDA  
HUSABERG  
HUSQVARNA  
KAWASAKI  
KTM  
MOTO TM  
RIEJU  
SHERCO  
SUZUKI  
YAMAHA

**STREET**  
APRILIA  
CAGIVA  
HONDA  
KAWASAKI  
KTM  
SUZUKI  
YAMAHA

**ATV-UTV**  
CAN-AM  
GAS GAS  
HONDA  
KAWASAKI  
KTM  
POLARIS  
SUZUKI  
YAMAHA

**PWC**  
KAWASAKI  
POLARIS  
SEA DOO  
YAMAHA

**SNOW**  
ARCTIC CAT  
KAWASAKI  
LYNX  
MOTO-SKI  
POLARIS  
SKI DOO  
YAMAHA

**MOPED & SCOOTER**

**MISC. TECH. SPECIAL**

<b>Air Filter</b> 52.14017 '19 52.13020 '20-21 52.14021 '22-23	<b>Inner Hub</b> 18.1348 '19-21	<b>Complete Plate Set</b> 16.CPS13018 '19 16.CPS13022 '22-23	<b>F/W Bearing</b> 23.S110081 '19-23	<b>Frontbrake Disc</b> 37.BD11315 '19-23	<b>Front Sprocket</b> 07.FS13018-12 07.FS13018-13 07.FS13018-14 '19-21 07.FS13088-12 07.FS13088-13 07.FS13088-14 07.FS13088-15 '22-23	<b>Chain</b> 07.RC520120C '19-23 MX 07.RC520120CG '19-23 MX Gold 07.RC520120XC '19-23 X-Ring 07.RC520120XCG '19-23 X-Ring Gold	<b>Swingarm</b> 26.210218 '19 26.210222 '20-23	<b>Seal &amp; Wiper</b> 40.S496011 '19-23
<b>Oil Filter</b> 54.13116 '19-23 1-Pce. 54.13116-50 '19-23 50-Pcs.	<b>Spring Kit</b> 17.CS33052 '19 17.CS33052 '22-23	<b>Friction Set</b> 16.S13093 '19-21 16.S13094 '22-23	<b>R/W Bearing</b> 23.S112050 '19-23	<b>Rearbrake Disc</b> 37.BD21202 '19-23	<b>Rear Pad Set</b> 37.103202 '19-23 37.103202BX '19-23 Box of 10	<b>Countershaft Seal Kit</b> 26.640008 '19-23	<b>Upper</b> 26.310013 '19-23	<b>Oil Seal Set</b> 40.F496011 '19-23
<b>Throttle Cable</b> 53.112064 '19-21 53.112085 '22-23	<b>Clutch Cable</b> 53.121043 '19-21 53.121054 '22-23	<b>Steel Set</b> 16.S13014 '19-21 16.S13095 '22-23	<b>F/W Spacer Kit</b> 26.710005 '19-23	<b>Front Pad Set</b> 37.103202 '19-23 37.103202BX '19-23 Box of 10	<b>Rear Pad Set</b> 37.208202 '19-23 37.208202BX '19-23 Box of 10	<b>7075-T6 Alloy Rear Sprocket</b> 07.RA12087-48 07.RA12087-49 07.RA12087-50 07.RA12087-51 07.RA12087-52 '19-23	<b>Lower Chain Roller</b> 33.0015 '19-23	<b>Dust Seal Set</b> 40.F4960D '19-23
			<b>R/W Spacer Kit</b> 26.710015 '19-23	<b>Rear Caliper Rebuild Kit</b> 37.63005 '19-23	<b>Steering Bearing</b> 24.110010 '19-23	<b>UltraLight Steel Rear Sprocket</b> 07.RS12087R-48 07.RS12087R-49 07.RS12087R-50 07.RS12087R-51 07.RS12087R-52 '19-23	<b>Upper Chain Roller</b> 33.0015 '19-23	<b>Rear Shock Seal Head Kit</b> 26.810126 '19-20
				<b>Front Master Cylinder Rebuild Kit</b> 37.910005 '19-23		<b>Sprocket Bolt Set</b> 07.SBSM825 '19-23		
				<b>Rear Master Cylinder Rebuild Kit</b> 37.910008 '19-23				

<b>Air Filter</b> 52.14004 '04-17	<b>Basket</b> 17.1220F * '04-17	<b>Complete Plate Set</b> 16.CPS13008 '04-17	<b>F/W Bearing</b> 23.S115021 '04-17	<b>Frontbrake Disc</b> 37.BD11295 '04-17	<b>Front Sprocket</b> 07.FS12004-12 07.FS12004-13 07.FS12004-14 '04-17	<b>Chain</b> 07.RC520120C '04-17 MX 07.RC520120CG '04-17 MX Gold 07.RC520120XC '04-17 X-Ring 07.RC520120XCG '04-17 X-Ring Gold	<b>Swingarm</b> 26.210127 '04-17	<b>Seal &amp; Wiper</b> 40.S475810 '04-17
<b>Main Jet</b> 45.100-225 '04-17 Keihin	<b>Clutch Rubber Set</b> 17.CRS1287-8 '04-17	<b>Friction Set</b> 16.S13035 '04-17	<b>R/W Bearing</b> 23.S112050 '04-17	<b>Rearbrake Disc</b> 37.BD21202 '04-17	<b>7075-T6 Alloy Rear Sprocket</b> 07.RA12087-48 07.RA12087-49 07.RA12087-50 07.RA12087-51 07.RA12087-52 '04-17	<b>Countershaft Seal Kit</b> 26.640009 '04-17	<b>Linkage</b> 26.110125 '04-17	<b>Oil Seal Set</b> 40.F475810 '04-17
<b>Pilot Jet</b> 46.040-085 '04-17 Keihin	<b>Inner Hub</b> 18.1337 '07-17	<b>Steel Set</b> 16.S13014 '04-17	<b>F/W Spacer Kit</b> 26.710007 '04-17	<b>Front Pad Set</b> 37.103202 '04-17 37.103202BX '04-17 Box of 10	<b>Front Pad Set</b> 37.103202 '04-17 37.103202BX '04-17 Box of 10	<b>UltraLight Steel Rear Sprocket</b> 07.RS12087R-48 07.RS12087R-49 07.RS12087R-50 07.RS12087R-51 07.RS12087R-52 '04-17	<b>Upper</b> 26.310013 '04-17	<b>Dust Seal Set</b> 40.F4758D '04-17
<b>Carburetor Rebuild Kit</b> 55.10457 '04-06 55.10475 '07 55.10476 '08-17	<b>Pressure Plate</b> 18.P1308 '04-17		<b>R/W Spacer Kit</b> 26.710015 '04-17	<b>Rear Pad Set</b> 37.208202 '04-17 37.208202BX '04-17 Box of 10	<b>Steering Bearing</b> 24.110010 '04-17	<b>Lower Chain Roller</b> 33.0007 '04-05 33.0015 '06-17	<b>Lower</b> 26.450008 '04-17	<b>Bushing Set</b> 39.160020 '04-17
<b>Throttle Cable</b> 53.110018 '04-17	<b>Cover Gasket</b> 19.G1334 '04-17			<b>Rear Caliper Rebuild Kit</b> 37.63005 '04-17		<b>UltraLight Steel Rear Sprocket</b> 07.RS12087R-48 07.RS12087R-49 07.RS12087R-50 07.RS12087R-51 07.RS12087R-52 '04-17	<b>Upper Chain Roller</b> 33.0010 '04-17	<b>Rear Shock Seal Head Kit</b> 26.810126 '04-17
<b>Oil Filter</b> 54.13116 '04-17 1-Pce. 54.13116-50 '04-17 50-Pcs.	<b>Clutch Cable</b> 53.120018 '04-07 53.120017 '08-17			<b>Front Master Cylinder Rebuild Kit</b> 37.910002 '04-17		<b>Sprocket Bolt Set</b> 07.SBSM825 '04-17		
<b>Water Pump Rebuild Kit</b> 57.1324 '04-17				<b>Rear Master Cylinder Rebuild Kit</b> 37.910008 '04-17				

**DIRT**  
APRILIA  
BETA  
BMW  
GAS GAS  
HONDA  
HUSABERG  
HUSQVARNA  
KAWASAKI  
KTM  
MOTO TM  
RIEJU  
SHERCO  
SUZUKI  
YAMAHA

**STREET**  
APRILIA  
CAGIVA  
HONDA  
KAWASAKI  
KTM  
SUZUKI  
YAMAHA

**ATV-UTV**  
CAN-AM  
GAS GAS  
HONDA  
KAWASAKI  
KTM  
POLARIS  
SUZUKI  
YAMAHA

**PWC**  
KAWASAKI  
POLARIS  
SEA DOO  
YAMAHA

**SNOW**  
ARCTIC CAT  
KAWASAKI  
LYNX  
MOTO-SKI  
POLARIS  
SKI DOO  
YAMAHA

**MOPED & SCOOTER**

**MISC. TECH. SPECIAL**



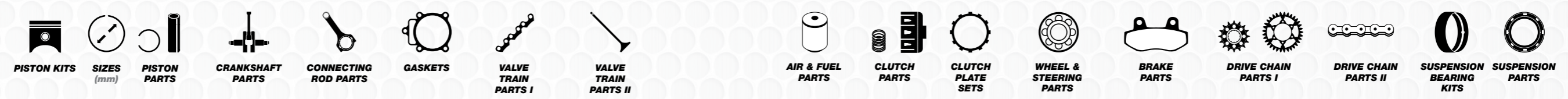

**HONDA**

DIRT	CRF 250 L 4-Stroke Please Note: Nikasil Piston Size -Std. Compression 10.7:1 -Fuel Injection	Piston Kit -	Size 76.00	Ring Set -					
APRILIA BETA BMW GAS GAS HONDA HUSABERG HUSQVARNA KAWASAKI KTM MOTO TM RIEJU SHERCO SUZUKI YAMAHA									
STREET	CRF 250 F 4-Stroke Please Note: Nikasil Piston Size -Std. Compression 9.6:1 -Fuel Injection	Piston Kit -	Size 71.00	Ring Set -				Valve Seal 35.VS003 '19-23 4x	
APRILIA CAGIVA HONDA KAWASAKI KTM SUZUKI YAMAHA									
ATV-UTV									
CAN-AM GAS GAS HONDA KAWASAKI KTM POLARIS SUZUKI YAMAHA									
PWC									
KAWASAKI POLARIS SEA DOO YAMAHA									
SNOW	XL / XR 250 S 4-Stroke	Piston Kit -	Size 74.00	Ring Set -	Bearing 23.6306C3 '79-83 Left 23.6306NR '79-83 Right	Con. Rod Kit 03.1353 '79-83			
ARCTIC CAT KAWASAKI LYNX MOTO-SKI POLARIS SKI DOO YAMAHA									
MOPED & SCOOTER									
MISC. TECH. SPECIAL									

Footnotes: \* Bearings Only \*\* Rubbers included

Oil Filter 54.44113 '13-14 1-Pce. 54.44113-50 '13-14 50-Pcs.			F/W Bearing 23.S116070 '13-16 23.S110063 '17	Front Caliper Rebuild Kit 37.63008 '13-17	Front Sprocket 07.FS13096-12 07.FS13096-13 07.FS13096-14 '13-17	Chain 07.RC520120C '13-17 MX 07.RC520120CG '13-17 MX Gold 07.RC520120XC '13-17 X-Ring 07.RC520120XCG '13-17 X-Ring Gold	Swingarm 26.210207 '13-17	Bushing Set 39.160115 '13-17
Air Filter 52.13009 '19-23			F/W Bearing 23.S114021 '19-23	Front Pad Set 37.103202 '19-23 37.103202BX '19-23 Box of 10	7075-T6 Alloy Rear Sprocket 07.RA12087-48 07.RA12087-49 07.RA12087-50 07.RA12087-51 07.RA12087-52 '19-23	Chain 07.RC520120C '19-23 MX 07.RC520120CG '19-23 MX Gold 07.RC520120XC '19-23 X-Ring 07.RC520120XCG '19-23 X-Ring Gold	Swingarm 26.210224 '19-23	Linkage 26.110196 '19-23
Oil Filter 54.44113 '19-23 1-Pce. 54.44113-50 '19-23 50-Pcs.			R/W Bearing 23.S117091 '19-23	Rear Pad Set 37.208202 '19-23 37.208202BX '19-23 Box of 10	UltraLight Steel Rear Sprocket 07.RS12087R-48 07.RS12087R-49 07.RS12087R-50 07.RS12087R-51 07.RS12087R-52 '19-23	Upper Chain Roller 33.0013 '19-23	Lower 26.450019 '19-23	
			Steering Bearing 24.110021 '19-23	Front Caliper Rebuild Kit 37.63005 '19-23	Sprocket Bolt Set 07.SBSM825 '19-23			
				Rear Caliper Rebuild Kit 37.63029 '19-23				
				Front Master Cylinder Rebuild Kit 37.910004 '19-23				
				Rear Master Cylinder Rebuild Kit 37.910008 '19-23				
			R/W Bearing 23.S11214 '78-81			Chain 07.RC520120C '79-83 MX 07.RC520120CG '79-83 MX Gold 07.RC520120XC '79-83 X-Ring 07.RC520120XCG '79-83 X-Ring Gold		Seal & Wiper 40.S354811 '79-80 40.S375011 '81-83
			Steering Bearing 24.110029 '78-81					Oil Seal Set 40.F354811 '79-80 40.F375011 '81-83
								Dust Seal Set 40.F3548D '79-80 40.F3750D '81-83

DIRT	APRILIA BETA BMW GAS GAS HONDA HUSABERG HUSQVARNA KAWASAKI KTM MOTO TM RIEJU SHERCO SUZUKI YAMAHA
STREET	APRILIA CAGIVA HONDA KAWASAKI KTM SUZUKI YAMAHA
ATV-UTV	CAN-AM GAS GAS HONDA KAWASAKI KTM POLARIS SUZUKI YAMAHA
PWC	KAWASAKI POLARIS SEA DOO YAMAHA
SNOW	ARCTIC CAT KAWASAKI LYNX MOTO-SKI POLARIS SKI DOO YAMAHA
MOPED & SCOOTER	
MISC. TECH. SPECIAL	



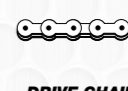

### HONDA

**DIRT**  
APRILIA  
BETA  
BMW  
GAS GAS  
HONDA  
HUSABERG  
HUSQVARNA  
KAWASAKI  
KTM  
MOTO TM  
RIEJU  
SHERCO  
SUZUKI  
YAMAHA

XR 250 R 4-Stroke	Piston Kit -	Size 73.00	Ring Set -	CrankBearing & Seal Kit 23.CBS13096 '96-04  Bearing 23.6328C3 '86-95 Right 23.6328/72C4 '96-04 2x	Con. Rod Kit 03.1357 '86-04	Complete 34.1356 '96-04  Top-End 35.1356 '86-95 35.1357 '96-04	Cam Chain 31.1384 '84-95 31.1396 '96-04	Valve 28.1356-1 '96-04 2x Exhaust Steel 28.1356-2 '96-04 2x Intake Steel  Valve Seal 35.VS001 '85-95 2x Intake 35.VS001 '85-95 2x Exhaust 35.VS003 '96-04 2x Intake 35.VS003 '96-04 2x Exhaust
----------------------	-----------------	---------------	---------------	---	-----------------------------------	--	---	--

**STREET**  
APRILIA  
CAGIVA  
HONDA  
KAWASAKI  
KTM  
SUZUKI  
YAMAHA

XR 250 Tornado 4-Stroke -Std. Compression 9.3:1	Piston Kit -	Size 73.00	Ring Set -		Con. Rod Kit 03.1358 '01-12		Cam Chain 31.1331 '01-12  Valve Shim Assortment 29.VSA748 '01-12 29.VSA748-2 '01-12	Valve Seal 35.VS003 '01-12 2x Intake 35.VS003 '01-12 2x Exhaust
---	-----------------	---------------	---------------	--	-----------------------------------	--	---	---

**ATV-UTV**  
CAN-AM  
GAS GAS  
HONDA  
KAWASAKI  
KTM  
POLARIS  
SUZUKI  
YAMAHA

XR 350 R 4-Stroke	Piston Kit -	Size 84.00	Ring Set -					
----------------------	-----------------	---------------	---------------	--	--	--	--	--

**SNOW**  
ARCTIC CAT  
KAWASAKI  
LYNX  
MOTO-SKI  
POLARIS  
SKI DOO  
YAMAHA

**MOPED & SCOOTER**

**MISC. TECH. SPECIAL**

Footnotes: \* Bearings Only \*\* Rubbers included

Air Filter 52.16087 '87-04  Main Jet 45.100-225 '96-04 Keihin  Pilot Jet 46.040-085 '96-04 Keihin  Carburetor Rebuild Kit 55.10545 '81-95  Throttle Cable 53.112008 '86-95 53.110020 '96-04  Oil Filter 54.44113 '82-04 1-Pce. 54.44113-50 '82-04 50-Pcs.	Clutch Cable 53.120098 '96-04	Friction Set 16.S13033 '86-95 16.S13034 '96-04  Steel Set 16.S13037 '84-04	F/W Bearing 23.S110069 '84-04  R/W Bearing 23.S112017 '86-95 23.S112006 '96-04  Steering Bearing 24.110021 81-04	Front Pad Set 37.105302 '90-95 37.105302BX '90-95 Box of 10 37.103202 '96-04 37.103202BX '96-04 Box of 10  Rear Pad Set 37.207102 '90-04 37.207102BX '90-04 Box of 10  Front Caliper Rebuild Kit 37.63009 '87 37.63005 '88-04  Rear Caliper Rebuild Kit 37.63028 '90-04  Front Master Cylinder Rebuild Kit 37.910001 '86-99 37.910002 '00-04  Rear Master Cylinder Rebuild Kit 37.910007 '90-95 37.910003 '96-04	7075-T6 Alloy Rear Sprocket 07.RA22099-48 07.RA22099-49 07.RA22099-50 07.RA22099-51 07.RA22099-52 '86-89 07.RA12087-48 07.RA12087-49 07.RA12087-50 07.RA12087-51 07.RA12087-52 '90-04  UltraLight Steel Rear Sprocket 07.RS22099R-47 07.RS22099R-48 07.RS22099R-49 07.RS22099R-50 07.RS22099R-51 07.RS22099R-52 '86-89 07.RS12087R-48 07.RS12087R-49 07.RS12087R-50 07.RS12087R-51 07.RS12087R-52 '90-04  Sprocket Bolt Set 07.SBSM825 '90-04	Chain 07.RC520120C '81-04 MX 07.RC520120CG '81-04 MX Gold 07.RC520120XC '81-04 X-Ring 07.RC520120XCG '81-04 X-Ring Gold	Swingarm 26.210021 '88-95 26.210011 '96-04  Linkage 26.110046 '86-95 26.110049 '96-04  Lower 26.310018 '86-04	Bushing Set 39.160018 '96-04  Rear Shock Seal Head Kit 26.810010 '84-95 26.810007 '96-04
---	-------------------------------------	--	--	--	--	---	---	--

**DIRT**  
APRILIA  
BETA  
BMW  
GAS GAS  
HONDA  
HUSABERG  
HUSQVARNA  
KAWASAKI  
KTM  
MOTO TM  
RIEJU  
SHERCO  
SUZUKI  
YAMAHA

**STREET**  
APRILIA  
CAGIVA  
HONDA  
KAWASAKI  
KTM  
SUZUKI  
YAMAHA

**ATV-UTV**  
CAN-AM  
GAS GAS  
HONDA  
KAWASAKI  
KTM  
POLARIS  
SUZUKI  
YAMAHA

Friction Set 16.S13036 '01-12  Steel Set 16.S13037 '01-12	Front Pad Set 37.103202 '01-12 37.103202BX '01-12 Box of 10	Chain 07.RC520120C '01-12 MX 07.RC520120CG '01-12 MX Gold 07.RC520120XC '01-12 X-Ring 07.RC520120XCG '01-12 X-Ring Gold
---	---	---

**SNOW**  
ARCTIC CAT  
KAWASAKI  
LYNX  
MOTO-SKI  
POLARIS  
SKI DOO  
YAMAHA

**MOPED & SCOOTER**

**MISC. TECH. SPECIAL**



**HONDA**

**DIRT**  
APRILIA  
BETA  
BMW  
GAS GAS  
HONDA  
HUSABERG  
HUSQVARNA  
KAWASAKI  
KTM  
MOTO TM  
RIEJU  
SHERCO  
SUZUKI  
YAMAHA

**STREET**  
APRILIA  
CAGIVA  
HONDA  
KAWASAKI  
KTM  
SUZUKI  
YAMAHA

**ATV-UTV**  
CAN-AM  
GAS GAS  
HONDA  
KAWASAKI  
KTM  
POLARIS  
SUZUKI  
YAMAHA

**PWC**  
KAWASAKI  
POLARIS  
SEA DOO  
YAMAHA

**SNOW**  
ARCTIC CAT  
KAWASAKI  
LYNX  
MOTO-SKI  
POLARIS  
SKI DOO  
YAMAHA

**MOPED & SCOOTER**

**MISC. TECH. SPECIAL**

XR 400 R 4-Stroke -Std. Compression 9.3:1	<b>Piston Kit</b> 01.1495.000 01.1495.025 01.1495.050 01.1495.100 '96-04	<b>Size (mm)</b> 85.00 85.25 85.50 86.00	<b>Ring Set</b> 02.1495.000 02.1495.025 02.1495.050 02.1495.100 '96-04	<b>CrankBearing &amp; Seal Kit</b> 23.CBS14096* '96-04	<b>Con. Rod Kit</b> 03.1495 '96-04	<b>Complete</b> 34.1416 '96-04	<b>Cam.Chain</b> 31.1496 '96-04	<b>Valve</b> 28.1495-1 '96-04 2x Exhaust Steel 28.1495-2 '96-04 2x Intake Steel	<b>Valve Seal</b> 35.VS001 '96-04 2x Intake 35.VS001 '96-04 2x Exhaust
			<b>Bearing</b> 23.SCO692C3 '96-04 2x		<b>Crankpin</b> 06.3466 '96-04	<b>Top-End</b> 35.1416 '96-04			
			<b>Clips</b> 05.2013 '96-04			<b>Ignition Cover Gasket</b> 19.G91496 '96-04			

Footnotes: \* Bearings Only \*\* Rubbers included

**DIRT**  
APRILIA  
BETA  
BMW  
GAS GAS  
HONDA  
HUSABERG  
HUSQVARNA  
KAWASAKI  
KTM  
MOTO TM  
RIEJU  
SHERCO  
SUZUKI  
YAMAHA

**STREET**  
APRILIA  
CAGIVA  
HONDA  
KAWASAKI  
KTM  
SUZUKI  
YAMAHA

**ATV-UTV**  
CAN-AM  
GAS GAS  
HONDA  
KAWASAKI  
KTM  
POLARIS  
SUZUKI  
YAMAHA

**PWC**  
KAWASAKI  
POLARIS  
SEA DOO  
YAMAHA

**SNOW**  
ARCTIC CAT  
KAWASAKI  
LYNX  
MOTO-SKI  
POLARIS  
SKI DOO  
YAMAHA

**MOPED & SCOOTER**

**MISC. TECH. SPECIAL**

<b>Air Filter</b> 52.16087 '96-04	<b>Inner Hub</b> 18.1495 '96-04	<b>Complete Plate Set</b> 16.CPS14096 '96-04	<b>F/W Bearing</b> 23.S110076 '96-04	<b>Front Pad Set</b> 37.103202 '96-04 37.103202BX '96-04 Box of 10	<b>Front Sprocket</b> 07.FS14096-14 07.FS14096-15 '96-04	<b>Chain</b> 07.RC520120C '96-04 MX 07.RC520120CG '96-04 MX Gold 07.RC520120XC '96-04 X-Ring 07.RC520120XCG '96-04 X-Ring Gold	<b>Swingarm</b> 26.210012 '96-04	<b>Seal &amp; Wiper</b> 40.S435411 '96-04
<b>Main Jet</b> 45.100-225 '96-04 Keihin	<b>Pressure Plate</b> 18.P1495 '96-04	<b>Friction Set</b> 16.S14017 '96-04	<b>R/W Bearing</b> 23.S112006 '96-04	<b>Rear Pad Set</b> 37.207102 '96-04 37.207102BX '96-04 Box of 10	<b>7075-T6 Alloy Rear Sprocket</b> 07.RA12087-48 07.RA12087-49 07.RA12087-50 07.RA12087-51 07.RA12087-52 '96-04	<b>Lower Chain Roller</b> 33.0008 '96-04	<b>Linkage</b> 26.110049 '96-97 26.110047 '98-04	<b>Oil Seal Set</b> 40.F435411 '96-04
<b>Pilot Jet</b> 46.040-085 '96-04 Keihin	<b>Spring Kit</b> 17.CS14007 '96-04	<b>Steel Set</b> 16.S14018 '96-04	<b>Steering Bearing</b> 24.110021 '96-04	<b>Front Caliper Rebuild Kit</b> 37.63005 '96-04	<b>UltraLight Steel Rear Sprocket</b> 07.RS12087R-48 07.RS12087R-49 07.RS12087R-50 07.RS12087R-51 07.RS12087R-52 '96-04	<b>Upper Chain Roller</b> 33.0013 '96-04	<b>Dust Seal Set</b> 40.F4354DP '96-04	<b>Upper</b> 26.310001 '98-04
<b>Throttle Cable</b> 53.111099 '96-04	<b>Clutch Cable</b> 53.120099 '96-04			<b>Rear Caliper Rebuild Kit</b> 37.63028 '96-04	<b>Sprocket Bolt Set</b> 07.SBSM825 '96-04	<b>Lower</b> 26.310018 '96-97 26.450019 '98-04	<b>Bushing Set</b> 39.160026 '96-97 39.160057 '98-04	<b>Rear Shock Seal Head Kit</b> 26.810114 '96-04
<b>Oil Filter</b> 54.44113 '96-04 1-Pce. 54.44113-50 '96-04 50-Pcs.				<b>Front Master Cylinder Rebuild Kit</b> 37.910001 '96-99 37.910002 '00-04				
				<b>Rear Master Cylinder Rebuild Kit</b> 37.910007 '96-04				





HONDA

Table with columns for model (e.g., CRF 450 R), Piston Kit, Size, Ring Set, Crankshaft, Con. Rod Kit, Complete, Cam Chain, Valve, and various other parts categories.

Footnotes: \* Bearings Only \*\* Rubbers included

Table with columns for Air Filter, Basket, Complete Plate Set, F/W Bearing, Frontbrake Disc, Front Sprocket, Chain, Swingarm, Seal & Wiper, and various other parts categories.

DIRT
APRILIA
BETA
BMW
GAS GAS
HONDA
HUSABERG
HUSQVARNA
KAWASAKI
KTM
MOTO TM
RIEJU
SHERCO
SUZUKI
YAMAHA
STREET
APRILIA
CAGIVA
HONDA
KAWASAKI
KTM
SUZUKI
YAMAHA
ATV-UTV
CAN-AM
GAS GAS
HONDA
KAWASAKI
KTM
POLARIS
SUZUKI
YAMAHA
PWC
KAWASAKI
POLARIS
SEA DOO
YAMAHA
SNOW
ARCTIC CAT
KAWASAKI
LYNX
MOTO-SKI
POLARIS
SKI DOO
YAMAHA
MOPED & SCOOTER
MISC. TECH. SPECIAL

DIRT
APRILIA
BETA
BMW
GAS GAS
HONDA
HUSABERG
HUSQVARNA
KAWASAKI
KTM
MOTO TM
RIEJU
SHERCO
SUZUKI
YAMAHA
STREET
APRILIA
CAGIVA
HONDA
KAWASAKI
KTM
SUZUKI
YAMAHA
ATV-UTV
CAN-AM
GAS GAS
HONDA
KAWASAKI
KTM
POLARIS
SUZUKI
YAMAHA
PWC
KAWASAKI
POLARIS
SEA DOO
YAMAHA
SNOW
ARCTIC CAT
KAWASAKI
LYNX
MOTO-SKI
POLARIS
SKI DOO
YAMAHA
MOPED & SCOOTER
MISC. TECH. SPECIAL



### HONDA

**DIRT**  
APRILIA  
BETA  
BMW  
GAS GAS  
HONDA  
HUSABERG  
HUSQVARNA  
KAWASAKI  
KTM  
MOTO TM  
RIEJU  
SHERCO  
SUZUKI  
YAMAHA

CRF 450 RX 4-Stroke Please Note: Nikasil Piston Size -Std. Compression 13.5:1 -Forged Piston -Fuel Injection	<b>Piston Kit</b> 01.1417.A 01.1417.B 01.1417.C '17-23	<b>Size</b> 95.96 95.97 95.98	<b>Ring Set</b> 02.3408 02.3408 02.3408 '17-23	<b>Bearing</b> 23.8ENK '17-23 Left  <b>Oilseal Set</b> 42.1417 '17-23	<b>Con. Rod Kit</b> 03.1417 '17-23  <b>B/E Bearing</b> 22.354320F '17-23  <b>Crankpin</b> 06.3567 '17-23  <b>Washer</b> 03W.35551.0 '17-23	<b>Complete</b> 34.1417 '17-18  <b>Top-End</b> 35.1417 '17-18 35.1419 '19-20 35.1421 '21-22 35.1423 '23  <b>Head &amp; Base</b> 36.1417 '17-18 36.1419 '19-20 36.1421 '21-22 36.1423 '23	<b>Cam Chain</b> 31.1417 '17-23  <b>Valve Shim Assortment</b> 29.VSA948 '17-23 29.VSA948-2 '17-23	<b>Valve</b> 28.1417-2 '17-23 2x Intake Titanium 28.1413-1 '17-23 2x Exhaust Steel  <b>Valve Seal</b> 35.VS004 '17-23 2x Intake 35.VS004 '17-23 2x Exhaust
--	--	--	--	---	--	--	---	--

**STREET**  
APRILIA  
CAGIVA  
HONDA  
KAWASAKI  
KTM  
SUZUKI  
YAMAHA

CRF 450 X 4-Stroke Please Note: Nikasil Piston Size -Std. Compression 12.0:1 -Forged Piston	<b>Piston Kit</b> 01.1414.A 01.1414.B 01.1414.C '05-17	<b>Size</b> 95.96 95.97 95.98	<b>Ring Set</b> 02.1402 02.1402 02.1402 '05-17	<b>Crankbearing &amp; Seal Kit</b> 23.CBS14005 '05-17  <b>Bearing</b> 23.8ENK '05-23 Left 23.SX06C84CS '05-17 Right	<b>Con. Rod Kit</b> 03.1405 '05-17  <b>Crankpin</b> 06.3464.9 '05-17	<b>Complete</b> 34.1403 '05-17  <b>Top-End</b> 35.1403 '05-17 35.1419 '19-23  <b>Head &amp; Base</b> 36.1405 '05-17 36.1419 '19-23  <b>Ignition Cover Gasket</b> 19.G91405 '05-17	<b>Cam Chain</b> 31.1403 '05-17 31.1419 '19-23  <b>Valve Shim Assortment</b> 29.VSA948 '05-23 29.VSA948-2 '05-23	<b>Valve</b> 28.1405-2 '05-17 2x Intake Titanium 28.1417-2 '19-23 2x Intake Titanium 28.1413-1 '19-23 2x Exhaust Steel  <b>TI-Steel Conversion Set</b> 28.SIS1405-2 '05-17 Intake  <b>Valve Seal</b> 35.VS001 '05-17 2x Intake 35.VS004 '05-17 2x Exhaust 35.VS004 '19-23 4x
--	--	--	--	---	--	---	--	---

**PWC**  
KAWASAKI  
POLARIS  
SEA DOO  
YAMAHA

Please Note: Nikasil Piston Size -Std. Compression 12.0:1 -Forged Piston	<b>Piston Kit</b> 01.1419.A 01.1419.B 01.1419.C '19-23	<b>Size</b> 95.96 95.97 95.98	<b>Ring Set</b> 02.1496 02.1496 02.1496 '19-23	<b>Pin</b> 04.1950.3 '05-17 04.1950.7 '19-23  <b>Clips</b> 05.1912 '05-23	<b>Oilseal Set</b> 42.1405 '05-17 42.1417 '19-23	<b>Ignition Cover Gasket</b> 19.G91405 '05-17		
---	--	--	--	---	--	---	--	--

**SNOW**  
ARCTIC CAT  
KAWASAKI  
LYNX  
MOTO-SKI  
POLARIS  
SKI DOO  
YAMAHA

--	--	--	--	--	--	--	--	--

**MOPED & SCOOTER**

**MISC. TECH. SPECIAL**

Footnotes: \* Bearings Only \*\* Rubbers included

<b>Air Filter</b> 52.14017 '17-20 52.14021 '21-23  <b>Throttle Cable</b> 53.112062 '17-18 53.112064 '19-20 53.112085 '21-23  <b>Oil Filter</b> 54.13116 '17-23 1-Pce. 54.13116-50 '17-23 50-Pcs.  <b>Water Pump Rebuild Kit</b> 57.1417 '17-19	<b>Clutch Rubber Set</b> 17.CRS1417-8 '17-23  <b>Inner Hub</b> 18.1417 '17-20 18.1421 '21-23  <b>Spring Kit</b> 17.CS13006 '17-20  <b>Clutch Cable</b> 53.121046 '17 53.121044 '18 53.121045 '19-20  <b>Master Cylinder Rebuild Kit</b> 16.940030 '21-22  <b>Slave Cylinder Rebuild Kit</b> 16.950040 '21-22	<b>Complete Plate Set</b> 16.CPS14017 '17-20  <b>Friction Set</b> 16.S14091 '17-20 16.S14039 '21-23  <b>Steel Set</b> 16.S14092 '17-20 16.S14016 '21-23	<b>F/W Bearing</b> 23.S110081 '17-23  <b>R/W Bearing</b> 23.S112050 '17-23  <b>F/W Spacer Kit</b> 26.710005 '17-23  <b>R/W Spacer Kit</b> 26.710015 '17-23  <b>Steering Bearing</b> 24.110010 '17-23	<b>Frontbrake Disc</b> 37.BD11315 '17-23  <b>Rearbrake Disc</b> 37.BD21202 '17-23  <b>Front Pad Set</b> 37.103202 '17-23 37.103202BX '17-23 Box of 10  <b>Rear Pad Set</b> 37.208202 '17-23 37.208202BX '17-23 Box of 10  <b>Front Caliper Rebuild Kit</b> 37.63005 '17-23  <b>Rear Caliper Rebuild Kit</b> 37.63029 '17-23  <b>Front Master Cylinder Rebuild Kit</b> 37.910005 '17-23  <b>Rear Master Cylinder Rebuild Kit</b> 37.910008 '17-23	<b>Front Sprocket</b> 07.FS13088-12 07.FS13088-13 07.FS13088-14 07.FS13088-15 '17-23  <b>7075-T6 Alloy Rear Sprocket</b> 07.RA12087-48 07.RA12087-49 07.RA12087-50 07.RA12087-51 07.RA12087-52 '17-23  <b>Ultralight Steel Rear Sprocket</b> 07.RS12087R-48 07.RS12087R-49 07.RS12087R-50 07.RS12087R-51 07.RS12087R-52 '17-23  <b>Sprocket Bolt Set</b> 07.SBSM825 '17-23	<b>Chain</b> 07.RC520120C '17-23 MX 07.RC520120CG '17-23 MX Gold 07.RC520120XC '17-23 X-Ring 07.RC520120XCG '17-23 X-Ring Gold  <b>Countershaft Seal Kit</b> 26.640008 '17-23  <b>Lower Chain Roller</b> 33.0015 '17-23  <b>Upper Chain Roller</b> 33.0015 '17-23	<b>Swingarm</b> 26.210218 '17-18 26.210222 '19-23  <b>Linkage</b> 26.110186 '17-23  <b>Upper</b> 26.310013 '17-23  <b>Lower</b> 26.450008 '17-23	<b>Seal &amp; Wiper</b> 40.S496011 '17-23  <b>Oil Seal Set</b> 40.F496011 '17-23  <b>Dust Seal Set</b> 40.F4960D '17-23  <b>Bushing Set</b> 39.1600131 '17-18  <b>Rear Shock Seal Head Kit</b> 26.810126 '17-20
--	--	---	--	--	---	---	--	---

**DIRT**  
APRILIA  
BETA  
BMW  
GAS GAS  
HONDA  
HUSABERG  
HUSQVARNA  
KAWASAKI  
KTM  
MOTO TM  
RIEJU  
SHERCO  
SUZUKI  
YAMAHA

**STREET**  
APRILIA  
CAGIVA  
HONDA  
KAWASAKI  
KTM  
SUZUKI  
YAMAHA

**ATV-UTV**  
CAN-AM  
GAS GAS  
HONDA  
KAWASAKI  
KTM  
POLARIS  
SUZUKI  
YAMAHA

**PWC**  
KAWASAKI  
POLARIS  
SEA DOO  
YAMAHA

**SNOW**  
ARCTIC CAT  
KAWASAKI  
LYNX  
MOTO-SKI  
POLARIS  
SKI DOO  
YAMAHA

**MOPED & SCOOTER**

**MISC. TECH. SPECIAL**

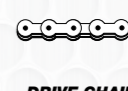

**HONDA**

**DIRT**  
APRILIA  
BETA  
BMW  
GAS GAS  
HONDA  
HUSABERG  
HUSQVARNA  
KAWASAKI  
KTM  
MOTO TM  
RIEJU  
SHERCO  
SUZUKI  
YAMAHA

**STREET**  
APRILIA  
CAGIVA  
HONDA  
KAWASAKI  
KTM  
SUZUKI  
YAMAHA

**ATV-UTV**  
CAN-AM  
GAS GAS  
HONDA  
KAWASAKI  
KTM  
POLARIS  
SUZUKI  
YAMAHA

**PWC**  
KAWASAKI  
POLARIS  
SEA DOO  
YAMAHA

**SNOW**  
ARCTIC CAT  
KAWASAKI  
LYNX  
MOTO-SKI  
POLARIS  
SKI DOO  
YAMAHA

**MOPED & SCOOTER**

**MISC. TECH. SPECIAL**

CRF 450 L / RL 4-Stroke Please Note: Nikasil Piston Size -Std. Compression 12.0:1 -Forged Piston	<b>Piston Kit</b> 01.1419.A 01.1419.B 01.1419.C '19-23	<b>Size</b> 95.96 95.97 95.98	<b>Ring Set</b> 02.1496 02.1496 02.1496 '19-23  <b>Pin</b> 04.1950.7 '19-23  <b>Clips</b> 05.1912 '19-23	<b>Bearing</b> 23.8ENK '19-23 Left  <b>Oilseal Set</b> 42.1417 '19-23	<b>Top-End</b> 35.1419 '19-23  <b>Head &amp; Base</b> 36.1419 '19-23	<b>Cam Chain</b> 31.1419 '19-23  <b>Valve Shim Assortment</b> 29.VSA948 '19-23 29.VSA948-2 '19-23	<b>Valve</b> 28.1417-2 '19-23 2x Intake Titanium 28.1413-1 '19-23 2x Exhaust Steel  <b>Valve Seal</b> 35.VS004 '19-23 4x
CR 480 2-Stroke	<b>Piston Kit</b> -	<b>Size</b> 89.00	<b>Ring Set</b> -				

Footnotes: \* Bearings Only \*\* Rubbers included

<b>Air Filter</b> 52.14019 '19-23  <b>Oil Filter</b> 54.13116 '19-23 1-Pce. 54.13116-50 '19-23 50-Pcs.  <b>Throttle Cable</b> 53.112065 '19-23	<b>Clutch Rubber Set</b> 17.CRS1417-8 '19-23  <b>Inner Hub</b> 18.1417 '19-23  <b>Clutch Cable</b> 53.121047 '19-23	<b>Friction Set</b> 16.S14091 '19-23  <b>Steel Set</b> 16.S14092 '19-23	<b>F/W Bearing</b> 23.S110081 '19-23  <b>R/W Bearing</b> 23.S112050 '19-23  <b>F/W Spacer Kit</b> 26.710005 '19-23  <b>R/W Spacer Kit</b> 26.710015 '19-23  <b>Steering Bearing</b> 24.110010 '19-23	<b>Rearbrake Disc</b> 37.BD21202 '19-23  <b>Rear Pad Set</b> 37.208202 '19-23 37.208202BX '19-23 Box of 10  <b>Front Caliper Rebuild Kit</b> 37.63005 '19-23  <b>Rear Caliper Rebuild Kit</b> 37.63029 '19-23  <b>Front Master Cylinder Rebuild Kit</b> 37.910002 '19-23  <b>Rear Master Cylinder Rebuild Kit</b> 37.910008 '19-23	<b>7075-T6 Alloy Rear Sprocket</b> 07.RA12087-48 07.RA12087-50 07.RA12087-51 07.RA12087-52 '19-23  <b>Ultralight Steel Rear Sprocket</b> 07.RS12087R-48 07.RS12087R-49 07.RS12087R-50 07.RS12087R-51 07.RS12087R-52 '19-23  <b>Sprocket Bolt Set</b> 07.SBSM825 '19-23	<b>Chain</b> 07.RC520120C '19-23 MX 07.RC520120CG '19-23 MX Gold 07.RC520120XC '19-23 X-Ring 07.RC520120XCG '19-23 X-Ring Gold  <b>Countershaft Seal Kit</b> 26.640008 '19-23	<b>Swingarm</b> 26.210218 '19-23  <b>Linkage</b> 26.110186 '19-23  <b>Upper</b> 26.310013 '19-23  <b>Lower</b> 26.450008 '19-23	<b>Seal &amp; Wiper</b> 40.S496011 '19-23  <b>Oil Seal Set</b> 40.F496011 '19-23  <b>Dust Seal Set</b> 40.F4960D '19-23  <b>Rear Shock Seal Head Kit</b> 26.810126 '19-20
			<b>R/W Bearing</b> 23.S111013 '82 23.S111015 '83  <b>Steering Bearing</b> 24.110021 '82-83			<b>Chain</b> 07.RC520120C '82-83 MX 07.RC520120CG '82-83 MX Gold 07.RC520120XC '83-83 X-Ring 07.RC520120XCG '83-83 X-Ring Gold  <b>Lower Chain Roller</b> 33.0007 '82-83  <b>Upper Chain Roller</b> 33.0007 '82-83	<b>Swingarm</b> 26.210142 '82-83	

**DIRT**  
APRILIA  
BETA  
BMW  
GAS GAS  
HONDA  
HUSABERG  
HUSQVARNA  
KAWASAKI  
KTM  
MOTO TM  
RIEJU  
SHERCO  
SUZUKI  
YAMAHA

**STREET**  
APRILIA  
CAGIVA  
HONDA  
KAWASAKI  
KTM  
SUZUKI  
YAMAHA

**ATV-UTV**  
CAN-AM  
GAS GAS  
HONDA  
KAWASAKI  
KTM  
POLARIS  
SUZUKI  
YAMAHA

**PWC**  
KAWASAKI  
POLARIS  
SEA DOO  
YAMAHA

**SNOW**  
ARCTIC CAT  
KAWASAKI  
LYNX  
MOTO-SKI  
POLARIS  
SKI DOO  
YAMAHA

**MOPED & SCOOTER**

**MISC. TECH. SPECIAL**





**PISTON KITS**



**SIZES (mm)**



**PISTON PARTS**



**CRANKSHAFT PARTS**



**CONNECTING ROD PARTS**



**GASKETS**



**VALVE TRAIN PARTS I**



**VALVE TRAIN PARTS II**



**AIR & FUEL PARTS**



**CLUTCH PARTS**



**CLUTCH PLATE SETS**



**WHEEL & STEERING PARTS**



**BRAKE PARTS**



**DRIVE CHAIN PARTS I**



**DRIVE CHAIN PARTS II**



**SUSPENSION BEARING KITS**



**SUSPENSION PARTS**



**HONDA**

**DIRT**  
APRILIA  
BETA  
BMW  
GAS GAS  
HONDA  
HUSABERG  
HUSQVARNA  
KAWASAKI  
KTM  
MOTO TM  
RIEJU  
SHERCO  
SUZUKI  
YAMAHA

**STREET**  
APRILIA  
CAGIVA  
HONDA  
KAWASAKI  
KTM  
SUZUKI  
YAMAHA

**ATV-UTV**  
CAN-AM  
GAS GAS  
HONDA  
KAWASAKI  
KTM  
POLARIS  
SUZUKI  
YAMAHA

**PWC**  
KAWASAKI  
POLARIS  
SEA DOO  
YAMAHA

**SNOW**  
ARCTIC CAT  
KAWASAKI  
LYNX  
MOTO-SKI  
POLARIS  
SKI DOO  
YAMAHA

**MOPED & SCOOTER**

**MISC. TECH. SPECIAL**

CR 500 2-Stroke	<b>Piston Kit</b> 01.1408.000 01.1408.025 01.1408.050 01.1408.075 01.1408.100 01.1408.125 01.1408.150 01.1408.200	<b>Size</b> 89.00 89.25 89.50 89.75 90.00 90.25 90.50 91.00	<b>Ring Set</b> 02.1406.000 02.1406.025 02.1406.050 02.1406.075 02.1406.100 02.1406.125 02.1406.150 02.1406.200	<b>Crank Bearing &amp; Seal Kit</b> 23.CBS13084 '82-01  <b>Bearing</b> 23.6328C3 '84-01 2x  <b>Oilseal Set</b> 42.1304 '84-01  <b>Pin</b> 04.2069 '82-01  <b>Clips</b> 05.2012 '82-01	<b>Con. Rod Kit</b> 03.1406 '87-01  <b>S/E Bearing</b> 21.1404 '82-01  <b>B/E Bearing</b> 22.263520F '87-01  <b>Crankpin</b> 06.2668 '87-01	<b>Complete</b> 34.1409 '89-01  <b>Top-End</b> 35.1405 '85-88 35.1409 '89-01  <b>Ignition Cover Gasket</b> 19.G91585 '85-01				
XL/XR 500 R 4-Stroke -Std. Compression 8.6:1 -Forged Piston	<b>Piston Kit</b> 01.1509.000 01.1509.050 01.1509.100 01.1509.150 01.1509.200	<b>Size</b> 89.00 89.50 90.00 90.50 91.00	<b>Ring Set</b> - - - - -	<b>Bearing</b> 23.6307C3 '79-82 2x	<b>B/E Bearing</b> 22.344220F '79-82					

Footnotes: \* Bearings Only \*\* Rubbers included

**DIRT**  
APRILIA  
BETA  
BMW  
GAS GAS  
HONDA  
HUSABERG  
HUSQVARNA  
KAWASAKI  
KTM  
MOTO TM  
RIEJU  
SHERCO  
SUZUKI  
YAMAHA

**STREET**  
APRILIA  
CAGIVA  
HONDA  
KAWASAKI  
KTM  
SUZUKI  
YAMAHA

**ATV-UTV**  
CAN-AM  
GAS GAS  
HONDA  
KAWASAKI  
KTM  
POLARIS  
SUZUKI  
YAMAHA

**PWC**  
KAWASAKI  
POLARIS  
SEA DOO  
YAMAHA

**SNOW**  
ARCTIC CAT  
KAWASAKI  
LYNX  
MOTO-SKI  
POLARIS  
SKI DOO  
YAMAHA

**MOPED & SCOOTER**

**MISC. TECH. SPECIAL**

<b>Air Filter</b> 52.12089 '89-01  <b>Main Jet</b> 45.100-225 '84-01 Keihin  <b>Pilot Jet</b> 46.040-085 '91-01 Keihin  <b>Carburetor Rebuild Kit</b> 55.10159 '90-01  <b>Throttle Cable</b> 53.110005 '84 53.110017 '85-89 53.110005 '90-01  <b>Water Pump Rebuild Kit</b> 57.1515 '85-01	<b>Basket</b> 17.1484 '84-89 17.1490 '90-01  <b>Clutch Rubber Set</b> 17.CRS1386-8 '90-01  <b>Inner Hub</b> 18.1490 90-01  <b>Clutch Cable</b> 53.120052 '84-01	<b>Complete Plate Set</b> 16.CPS15090 '90-01  <b>Friction Set</b> 16.S13008 '84-89 16.S13010 '90-01  <b>Alloy Set</b> 16.S13009 '84-89 16.S13011 '90-01	<b>F/W Bearing</b> 23.S110075 '85-94 23.S110081 '95-01  <b>R/W Bearing</b> 23.S111015 '84-86 23.S112041 '87-88 23.S112003 '89 23.S112002 '90-01  <b>F/W Spacer Kit</b> 26.710004 '96-01  <b>R/W Spacer Kit</b> 26.710013 '88-01  <b>Steering Bearing</b> 24.110021 '84-89 24.110018 '90-01	<b>Frontbrake Disc</b> 37.BD11295 '95-01  <b>Rearbrake Disc</b> 37.BD21289 '90-01  <b>Front Pad Set</b> 37.105302 '87-94 37.105302BX '87-94 Box of 10 37.103202 '95-01 37.103202BX '95-01 Box of 10  <b>Rear Pad Set</b> 37.207102 '87-01 37.207102BX '87-01 Box of 10  <b>Front Caliper Rebuild Kit</b> 37.63004 '84-86 37.63005 '87-01  <b>Rear Caliper Rebuild Kit</b> 37.63028 '87-01  <b>Front Master Cylinder Rebuild Kit</b> 37.910001 '84-98 37.910002 '99-01  <b>Rear Master Cylinder Rebuild Kit</b> 37.910007 '87-01	<b>Front Sprocket</b> 07.FS13088-12 07.FS13088-13 07.FS13088-14 07.FS13088-15 '88-01  <b>7075-T6 Alloy Rear Sprocket</b> 07.RA12087-48 07.RA12087-50 07.RA12087-51 07.RA12087-52 '88-01  <b>UltraLight Steel Rear Sprocket</b> 07.RS12087R-48 07.RS12087R-49 07.RS12087R-50 07.RS12087R-51 07.RS12087R-52 '88-01  <b>Sprocket Bolt Set</b> 07.SBSM825 '88-01	<b>Chain</b> 07.RC520120C '84-01 MX 07.RC520120CG '84-01 MX Gold 07.RC520120XC '84-01 X-Ring 07.RC520120XCG '84-01 X-Ring Gold  <b>Countershaft Seal Kit</b> 26.640008 '88-01  <b>Lower Chain Roller</b> 33.0006 '84 33.0008 '85-01  <b>Upper Chain Roller</b> 33.0006 '84-01	<b>Swingarm</b> 26.210142 '84 26.210013 '85 26.210014 '86 26.210013 '87-88 26.210030 '89-01  <b>Linkage</b> 26.110016 '85-88 26.110026 '89-90 26.110019 '91-92 26.110021 '93-94 26.110024 '95 26.110025 '96-01  <b>Upper</b> 26.310015 '85 26.310006 '91-93 26.310012 '94-95 26.310013 '96-01	<b>Seal &amp; Wiper</b> 40.S435411 '85-88 40.S455711P '89-91 40.S43549 '92-94 40.S43559 '95 40.S46589 '96-01  <b>Oil Seal Set</b> 40.F435411 '85-88 40.F43549 '92-94 40.F43559 '95 40.F46589 '96-01  <b>Dust Seal Set</b> 40.F4354DP '85-88 40.F4557DP '89-91 40.F4354DP '92-94 40.F4355DP '95 40.F4658D '96-01  <b>Bushing Set</b> 39.160085 '85-87 39.160005 '88 39.160006 '90-91 39.160024 '95 39.160025 '96-01  <b>Rear Shock Seal Head Kit</b> 26.810011 '85-87 26.810114 '88-90 26.810007 '91-93 26.810004 '95-01
<b>Oil Filter</b> 54.44113 '81-85 1-Pce. 54.44113-50 '81-85 50-Pcs.			<b>R/W Bearing</b> 23.S112014 '79-84  <b>Steering Bearing</b> 24.110021 '81-84	<b>7075-T6 Alloy Rear Sprocket</b> 07.RA22099-47 07.RA22099-48 07.RA22099-49 07.RA22099-50 07.RA22099-51 07.RA22099-52 '79-87  <b>UltraLight Steel Rear Sprocket</b> 07.RS22099R-47 07.RS22099R-48 07.RS22099R-49 07.RS22099R-50 07.RS22099R-51 07.RS22099R-52 '79-87  <b>Sprocket Bolt Set</b> 07.SBSM825 '79-87	<b>Chain</b> 07.RC520120C '79-87 MX 07.RC520120CG '79-87 MX Gold 07.RC520120XC '79-87 X-Ring 07.RC520120XCG '79-87 X-Ring Gold	<b>Lower Chain Roller</b> 33.0002 '81  <b>Upper Chain Roller</b> 33.0002 '81		



### HONDA

**DIRT**  
APRILIA  
BETA  
BMW  
GAS GAS  
HONDA  
HUSABERG  
HUSQVARNA  
KAWASAKI  
KTM  
MOTO TM  
RIEJU  
SHERCO  
SUZUKI  
YAMAHA

**STREET**  
APRILIA  
CAGIVA  
HONDA  
KAWASAKI  
KTM  
SUZUKI  
YAMAHA

**ATV-UTV**  
CAN-AM  
GAS GAS  
HONDA  
KAWASAKI  
KTM  
POLARIS  
SUZUKI  
YAMAHA

**PWC**  
KAWASAKI  
POLARIS  
SEA DOO  
YAMAHA

**SNOW**  
ARCTIC CAT  
KAWASAKI  
LYNX  
MOTO-SKI  
POLARIS  
SKI DOO  
YAMAHA

**MOPED & SCOOTER**

**MISC. TECH. SPECIAL**

	Piston Kit	Size	Ring Set	CrankBearing & Seal Kit	Con. Rod Kit	Complete	Cam Chain	Valve
XR 600 R 4-Stroke -Std. Compression 9.0:1	01.1654.000 01.1654.025 01.1654.050 01.1654.075 01.1654.100 '85-00	97.00 97.25 97.50 97.75 98.00	- - - 02.1654.075 - '85-00	23.CBS16085* '85-00  <b>Bearing</b> 23.6308C3 '85-00 Left 23.6307/18 '85-00 Right  <b>Clips</b> 05.2414 '85-00	03.1654 '83-00	34.1613 '85-00  <b>Top-End</b> 35.1613 '85-00  <b>Ignition Cover Gasket</b> 19.G91685 '85-00	31.1655 '93-00	28.1654-1 '93-00 2x Exhaust Steel 28.1654-2 '93-00 2x Intake Steel  <b>Valve Seal</b> 35.VS005 '88-00 2x Intake 35.VS005 '88-00 2x Exhaust
FMX 650 4-Stroke -Std. Compression 8.3:1 -Forged Piston	01.1660.000 01.1660.050 01.1660.100 '05-07	100.00 100.50 101.00	02.5594.000 02.5594.050 02.5594.100 '05-07  <b>Clips</b> 05.2412 '05-07	23.SC0887C3 '05-07 Left 23.SC07A08 '05-07 Right	03.1660 '05-07  <b>Crankpin</b> 06.3671 '05-07	19.G91693 '05-07	31.1655 '05-07	28.1654-1 '05-07 2x Exhaust Steel 28.1654-2 '05-07 2x Intake Steel
NX 650 Dominator 4-Stroke -Std. Compression 8.3:1 -Forged Piston	01.1660.000 01.1660.050 01.1660.100 '96-02	100.00 100.50 101.00	02.5594.000 02.5594.050 02.5594.100 '96-02  <b>Clips</b> 05.2412 '96-02	23.SC0887C3 '88-02 Left 23.SC07A08 '88-02 Right	03.1660 '88-02  <b>Crankpin</b> 06.3671 '88-02		31.1655 '88-94 31.6301 '95-02	28.1654-1 '88-94 2x Exhaust Steel 28.1654-2 '88-02 2x Intake Steel
SLR 650 4-Stroke -Std. Compression 8.3:1 -Forged Piston	01.1660.000 01.1660.050 01.1660.100 '97-00	100.00 100.50 101.00	02.5594.000 02.5594.050 02.5594.100 '97-00  <b>Clips</b> 05.2412 '97-00	23.SC0887C3 '97-00 Left 23.SC07A08 '97-00 Right	03.1660 '97-00  <b>Crankpin</b> 06.3671 '97-00			28.1654-1 '97-00 2x Exhaust Steel 28.1654-2 '97-00 2x Intake Steel

Footnotes: \* Bearings Only \*\* Rubbers included

**DIRT**  
APRILIA  
BETA  
BMW  
GAS GAS  
HONDA  
HUSABERG  
HUSQVARNA  
KAWASAKI  
KTM  
MOTO TM  
RIEJU  
SHERCO  
SUZUKI  
YAMAHA

**STREET**  
APRILIA  
CAGIVA  
HONDA  
KAWASAKI  
KTM  
SUZUKI  
YAMAHA

**ATV-UTV**  
CAN-AM  
GAS GAS  
HONDA  
KAWASAKI  
KTM  
POLARIS  
SUZUKI  
YAMAHA

**PWC**  
KAWASAKI  
POLARIS  
SEA DOO  
YAMAHA

**SNOW**  
ARCTIC CAT  
KAWASAKI  
LYNX  
MOTO-SKI  
POLARIS  
SKI DOO  
YAMAHA

**MOPED & SCOOTER**

**MISC. TECH. SPECIAL**

Air Filter	Spring Kit	Complete Plate Set	F/W Bearing	Front Pad Set	Front Sprocket	Chain	Swingarm	Seal & Wiper
52.16087 '87-00  <b>Main Jet</b> 45.100-225 '86-00 Keihin  <b>Pilot Jet</b> 46.040-085 '96-00 Keihin  <b>Throttle Cable</b> 53.110021 '85-87 53.110022 '88-00  <b>Oil Filter</b> 54.44113 '85-00 1-Pce. 54.44113-50 '85-00 50-Pcs.	17.CS16046 '85-00  <b>Clutch Cable</b> 53.121041 '85-00	16.CPS16085 '85-00  <b>Friction Set</b> 16.S16019 '85-00  <b>Steel Set</b> 16.S16020 '85-00	23.S110069 '85-92 23.S110076 '93-00  <b>R/W Bearing</b> 23.S112017 '85-00  <b>Steering Bearing</b> 24.110021 '85-00	37.103202 '93-00 37.103202BX '93-00 Box of 10  <b>Rear Pad Set</b> 37.207102 '93-00 37.207102BX '93-00 Box of 10  <b>Front Caliper Rebuild Kit</b> 37.63004 '85-87 37.63005 '88-00  <b>Front Master Cylinder Rebuild Kit</b> 37.910001 '85-00  <b>Rear Master Cylinder Rebuild Kit</b> 37.910007 '91-00	07.FS14095-13 07.FS14095-14 07.FS14095-15 '91-00  <b>7075-T6 Alloy Rear Sprocket</b> 07.RA22099-47 07.RA22099-48 07.RA22099-49 07.RA22099-50 07.RA22099-51 07.RA22099-52 '85-87  07.RA12087-48 07.RA12087-49 07.RA12087-50 07.RA12087-51 07.RA12087-52 '91-00  <b>Ultralight Steel Rear Sprocket</b> 07.RS22099R-47 07.RS22099R-48 07.RS22099R-49 07.RS22099R-50 07.RS22099R-51 07.RS22099R-52 '85-87  07.RS12087R-48 07.RS12087R-49 07.RS12087R-50 07.RS12087R-51 07.RS12087R-52 '91-00  <b>Sprocket Bolt Set</b> 07.SBSM825 '85-00	07.RC520120C '85-00 MX 07.RC520120CG '85-00 MX Gold 07.RC520120XC '85-00 X-Ring 07.RC520120XCG '85-00 X-Ring Gold	26.210020 '88-00  <b>Linkage</b> 26.110046 '85-00  <b>Upper</b> 26.310018 '85-87  <b>Lower</b> 26.310018 '85-00	40.S435411 '85-00  <b>Oil Seal Set</b> 40.F435411 '85-00  <b>Dust Seal Set</b> 40.F4354DP '85-00  <b>Seal Head Kit</b> 26.810114 '91-00
54.44113 '05-07 1-Pce. 54.44113-50 '05-07 50-Pcs.			24.110021 '05-07			07.RC520120C '05-07 MX 07.RC520120CG '05-07 MX Gold 07.RC520120XC '05-07 X-Ring 07.RC520120XCG '05-07 X-Ring Gold	26.450019 '05-07	
						07.RC520120C '88-02 MX 07.RC520120CG '88-02 MX Gold 07.RC520120XC '88-02 X-Ring 07.RC520120XCG '88-02 X-Ring Gold	40.S435411 '88-02  <b>Oil Seal Set</b> 40.F435411 '88-02  <b>Dust Seal Set</b> 40.F4354DP '88-02	
						07.RC520120C '97-01 MX 07.RC520120CG '97-01 MX Gold 07.RC520120XC '97-01 X-Ring 07.RC520120XCG '97-01 X-Ring Gold		



**HONDA**

DIRT	XR 650 L	Piston Kit	Size	Ring Set	Crank Bearing & Seal Kit	Con. Rod Kit	Complete	Cam Chain	Valve
APRILIA BETA BMW GAS GAS HONDA HUSABERG HUSQVARNA KAWASAKI KTM MOTO TM RIEJU SHERCO SUZUKI YAMAHA	4-Stroke -Std. Compression 8.3:1 -Forged Piston	01.1660.000 01.1660.050 01.1660.100 '93-22	100.00 100.50 101.00	02.5594.000 02.5594.050 02.5594.100 '93-22	23.CBS16093* '93-22  <b>Bearing</b> 23.SC0887C3 '93-22 Left 23.SC07A08 '93-22 Right	03.1660 '93-22  <b>Crankpin</b> 06.3671 '93-22  <b>B/E Bearing</b> 22.364523F-1 '93-22	34.1693 '93-22  <b>Top-End</b> 35.1623 '93-22  <b>Ignition Cover Gasket</b> 19.G91693 '93-22	31.1655 '93-22	28.1654-1 '93-22 2x Exhaust Steel 28.1654-2 '93-22 2x Intake Steel  <b>Valve Seal</b> 35.VS005 '93-22 2x Intake 35.VS005 '93-22 2x Exhaust
<b>STREET</b> APRILIA CAGIVA HONDA KAWASAKI KTM SUZUKI YAMAHA									
<b>ATV-UTV</b> CAN-AM GAS GAS HONDA KAWASAKI KTM POLARIS SUZUKI YAMAHA	XR 650 R 4-Stroke Please Note: Nikasil Piston Size -Std. Compression 10.0:1 - 01.1662 series is Forged	01.1662.A 01.1662.B 01.1662.C & 01.1661.100 '00-07	99.94 99.95 99.96 101.00	02.5594.000 02.5594.000 02.5594.000 02.1661.100 '00-07	23.SC0887C3 '00-07 Left	03.1661 '00-07		31.1661 '00-07	35.VS006 '00-07 2x Intake 35.VS005 '00-07 2x Exhaust
<b>PWC</b> KAWASAKI POLARIS SEA DOO YAMAHA	Replating or Cylinder Sleaving Required for Oversizes			<b>Pin</b> 04.2363.5 '00-07  <b>Clips</b> 05.2312 '00-07					
<b>SNOW</b> ARCTIC CAT KAWASAKI LYNX MOTO-SKI POLARIS SKI DOO YAMAHA									
<b>MOPED &amp; SCOOTER</b>									
<b>MISC. TECH. SPECIAL</b>									

Footnotes: \* Bearings Only \*\* Rubbers included

Air Filter	Spring Kit	F/W Bearing	Front Pad Set	Front Sprocket	Chain	Swingarm	Seal & Wiper
52.16087 '93-22  <b>Main Jet</b> 45.393095-190 '93-22 Keihin  <b>Pilot Jet</b> 46.F025-F060 '93-22 Keihin  <b>Throttle Cable</b> 53.110025 '93-22  <b>Oil Filter</b> 54.44113 '93-22 1-Pce. 54.44113-50 '93-22 50-Pcs.	17.CS16046 '93-22  <b>Clutch Cable</b> 53.121003 '93-22	23.S110076 '93-22  <b>R/W Bearing</b> 23.S112014 '93-22  <b>Steering Bearing</b> 24.110021 '93-22	37.103202 '93-22 37.103202BX '93-22 Box of 10  <b>Rear Pad Set</b> 37.207102 '93-22 37.207102BX '93-22 Box of 10  <b>Front Caliper Rebuild Kit</b> 37.63005 '93-22  <b>Rear Caliper Rebuild Kit</b> 37.63028 '93-22  <b>Front Master Cylinder Rebuild Kit</b> 37.910004 '93-22  <b>Rear Master Cylinder Rebuild Kit</b> 37.910007 '93-22	07.FS14095-13 07.FS14095-14 07.FS14095-15 '93-22  <b>7075-T6 Alloy Rear Sprocket</b> 07.RA12087-48 07.RA12087-49 07.RA12087-50 07.RA12087-51 07.RA12087-52 '93-22  <b>Sprocket Bolt Set</b> 07.SBSM825 '93-22	07.RC520120C '93-22 MX 07.RC520120CG '93-22 MX Gold 07.RC520120XC '93-22 X-Ring 07.RC520120XCG '93-22 X-Ring Gold	26.210020 '93-22  <b>Linkage</b> 26.110046 '93-22  <b>Lower</b> 26.310018 '93-22	40.S435411 '93-22  <b>Oil Seal Set</b> 40.F435411 '93-22  <b>Dust Seal Set</b> 40.F4354DP '93-22  <b>Bushing Set</b> 39.160026 '93-22
52.16000 '00-07  <b>Main Jet</b> 45.100-225 '00-07 Keihin  <b>Pilot Jet</b> 46.040-085 '00-07 Keihin  <b>Throttle Cable</b> 53.110023 '00-07  <b>Oil Filter</b> 54.44113 '00-07 1-Pce. 54.44113-50 '00-07 50-Pcs.	17.CS16045 '00-07  <b>Clutch Cable</b> 53.121004 '00-07	23.S110076 '00-07  <b>R/W Bearing</b> 23.S111013 '00-07  <b>Steering Bearing</b> 24.110018 '00-07	37.103202 '00-07 37.103202BX '00-07 Box of 10  <b>Rear Pad Set</b> 37.207102 '00-07 37.207102BX '00-07 Box of 10  <b>Front Caliper Rebuild Kit</b> 37.63005 '00-07  <b>Rear Caliper Rebuild Kit</b> 37.63028 '00-07  <b>Front Master Cylinder Rebuild Kit</b> 37.910002 '00-07  <b>Rear Master Cylinder Rebuild Kit</b> 37.910007 '00-07	07.RA12087-48 07.RA12087-49 07.RA12087-50 07.RA12087-51 07.RA12087-52 '00-07  <b>7075-T6 Alloy Rear Sprocket</b> 07.RS12087R-48 07.RS12087R-49 07.RS12087R-50 07.RS12087R-51 07.RS12087R-52 '00-07  <b>Sprocket Bolt Set</b> 07.SBSM825 '00-07	07.RC520120C '00-07 MX 07.RC520120CG '00-07 MX Gold 07.RC520120XC '00-07 X-Ring 07.RC520120XCG '00-07 X-Ring Gold	26.210108 '00-07  <b>Linkage</b> 26.110112 '00-07  <b>Upper</b> 26.350055 '00-07  <b>Lower</b> 26.450008 '00-07	40.S46589 '00-07  <b>Oil Seal Set</b> 40.F46589 '00-07  <b>Dust Seal Set</b> 40.F4658D '00-07  <b>Bushing Set</b> 39.160027 '00-07

DIRT	APRILIA BETA BMW GAS GAS HONDA HUSABERG HUSQVARNA KAWASAKI KTM MOTO TM RIEJU SHERCO SUZUKI YAMAHA
<b>STREET</b> APRILIA CAGIVA HONDA KAWASAKI KTM SUZUKI YAMAHA	
<b>ATV-UTV</b> CAN-AM GAS GAS HONDA KAWASAKI KTM POLARIS SUZUKI YAMAHA	
<b>PWC</b> KAWASAKI POLARIS SEA DOO YAMAHA	
<b>SNOW</b> ARCTIC CAT KAWASAKI LYNX MOTO-SKI POLARIS SKI DOO YAMAHA	
<b>MOPED &amp; SCOOTER</b>	
<b>MISC. TECH. SPECIAL</b>	





### HUSABERG

DIRT	TE 125 2-Stroke Please Note: Nikasil Piston Size	Piston Kit 01.6226.A 01.6226.B 01.6226.C 01.6226.D 01.6226.E '12-14	Size 53.94 53.95 53.96 53.97 53.98	Ring Set 02.6225 02.6225 02.6225 02.6225 02.6225 '12-14	CrankBearing & Seal Kit 23.CBS62001 '12-14  Bearing 23.NJ206 '12-14 Left 23.6305JR2 '12-14 Right  Oilseal Set 42.6218 '12-14  Pin 04.1545 '12-14  Clips 05.1510 '12-14	Con. Rod Kit 03.6220 '12-14  S/E Bearing 21.3206 '12-14  B/E Bearing 22.222816F '12-14  Crankpin 06.2255 '12-14	Complete 34.6227 '12-14  Top-End 35.6227 '12-14  Top-End 35.6227 '12-14
APRILIA BETA BMW GAS GAS HONDA HUSABERG HUSQVARNA KAWASAKI KTM MOTO TM RIEJU SHERCO SUZUKI YAMAHA							
STREET							
ATV-UTV							
PWC							
SNOW							
MOPED & SCOOTER							
MISC. TECH. SPECIAL							

Footnotes: \* Bearings Only \*\* Rubbers included

Air Filter 52.62010 '12 52.62011 '13-14  Main Jet 45.100-225 '12-14 Keihin  Pilot Jet 46.040-085 '12-14 Keihin  Throttle Cable 53.110046 '12-14	Inner Hub 18.1290 '12-14  Pressure Plate 18.P1286 '12  Spring Kit 17.CS62048 '12 17.CS12003 '13-14  Cover Gasket 19.G6218 '12-14	Complete Plate Set 16.CPS62008 '12-14  Friction Set 16.S52001 '12-14  Steel/Alloy 16.S52002 '12-14	F/W Bearing 23.S114002 '12-14  R/W Bearing 23.S112073 '12-14  F/W Spacer Kit 26.710087 '12-14  R/W Spacer Kit 26.710084 '12-14  Steering Bearing 24.110026 '12-14	Frontbrake Disc 37.BD16290 '12-14  Rearbrake Disc 37.BD26190 '12-14  Front Pad Set 37.102202 '12-14 37.102202BX '12-14 Box of 10  Rear Pad Set 37.202302 '12-14 37.202302BX '12-14 Box of 10  Front Caliper Rebuild Kit 37.63046 '12-14  Rear Caliper Rebuild Kit 37.63048 '12-14  Brake Pedal Rebuild Kit 37.RBPK001 '12-14	Front Sprocket 07.FS62093-12 07.FS62093-13 07.FS62093-14 07.FS62093-15 '12-14  7075-T6 Alloy Rear Sprocket 07.RA62090-48 07.RA62090-49 07.RA62090-50 07.RA62090-51 07.RA62090-52 '12-14  UltraLight Steel Rear Sprocket 07.RS62090R-48 07.RS62090R-49 07.RS62090R-50 07.RS62090R-51 07.RS62090R-52 '12-14  Sprocket Bolt Set 07.SBSM825 '12-14	Chain 07.RC520120C '12-14 MX 07.RC520120CG '12-14 MX Gold 07.RC520120XC '12-14 X-Ring 07.RC520120XCG '12-14 X-Ring Gold  Countershaft Seal Kit 26.640001 '12-14	Swingarm 26.210168 '12-14  Upper 26.350059 '12-14  Lower 26.410089 '12-14	Seal & Wiper 40.S4857.89 '12  Oil Seal Set 40.F4857.89 '12  Dust Seal Set 40.F4857.8D '12  Bushing Set 39.160074 '12  Rear Shock Seal Head Kit 26.810119 '12-14
Air Filter 52.62010 '11-12 52.62011 '13-14  Main Jet 45.100-45.225 '11-14 Keihin  Carburetor Rebuild Kit 55.10514 '11-14  Pilot Jet 46.040-46.085 '11-14 Keihin  Throttle Cable 53.110046 '11-14	Basket 17.6323F '11-12  Spring Kit 17.CS63011 '11-12  Inner Cover / Case Gasket 19.G6323 '11-14  Cover Gasket 19.G6324 '11-14  Master Cylinder Rebuild Kit 16.940000 '11-14  Slave Cylinder Rebuild Kit 16.950000 '11-14	Complete Plate Set 16.CPS64012 '13-14  Friction Set 16.S53014 '11-12 16.S53011 '13-14  Steel Set 16.S53029 '13-14	F/W Bearing 23.S114002 '11-14  R/W Bearing 23.S112073 '11-14  F/W Spacer Kit 26.710087 '11-14  R/W Spacer Kit 26.710084 '11-14  Steering Bearing 24.110026 '11-14	Frontbrake Disc 37.BD16290 '11-14  Rearbrake Disc 37.BD26190 '11-14  Front Pad Set 37.102202 '11-14 37.102202BX '11-14 Box of 10  Rear Pad Set 37.202302 '11-14 37.202302BX '11-14 Box of 10  Front Caliper Rebuild Kit 37.63046 '11-14  Rear Caliper Rebuild Kit 37.63048 '11-14  Front Master Cylinder Rebuild Kit 37.910026 '11-13 37.910024 '14  Rear Master Cylinder Rebuild Kit 37.910028 '11 37.910030 '12-14  Brake Pedal Rebuild Kit 37.RBPK001 '11-14	Front Sprocket 07.FS62093-12 07.FS62093-13 07.FS62093-14 07.FS62093-15 '11-14  7075-T6 Alloy Rear Sprocket 07.RA62090-48 07.RA62090-49 07.RA62090-50 07.RA62090-51 07.RA62090-52 '11-14  UltraLight Steel Rear Sprocket 07.RS62090R-48 07.RS62090R-49 07.RS62090R-50 07.RS62090R-51 07.RS62090R-52 '11-14  Sprocket Bolt Set 07.SBSM825 '11-14	Chain 07.RC520120C '11-14 MX 07.RC520120CG '11-14 MX Gold 07.RC520120XC '11-14 X-Ring 07.RC520120XCG '11-14 X-Ring Gold	Swingarm 26.210168 '11-14  Upper 26.350059 '11-14  Lower 26.410089 '11-14	Seal & Wiper 40.S4857.89 '11-12  Oil Seal Set 40.F4857.89 '11-12  Dust Seal Set 40.F4857.8D '11-12  Bushing Set 39.160074 '11 39.160082 '12 39.160122 '14  Rear Shock Seal Head Kit 26.810119 '11-14
APRILIA BETA BMW GAS GAS HONDA KAWASAKI KTM MOTO TM RIEJU SHERCO SUZUKI YAMAHA								
STREET								
ATV-UTV								
PWC								
SNOW								
MOPED & SCOOTER								
MISC. TECH. SPECIAL								

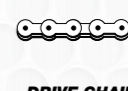

**HUSABERG**

**DIRT**  
APRILIA  
BETA  
BMW  
GAS GAS  
HONDA  
HUSABERG  
HUSQVARNA  
KAWASAKI  
KTM  
MOTO TM  
RIEJU  
SHERCO  
SUZUKI  
YAMAHA

FE 250  
4-Stroke  
Please Note:  
Nikasil Piston Size  
-Std. Compression 12.2:1  
-Forged Piston  
-Fuel Injection

**Piston Kit**  
01.6338.A  
01.6338.B  
01.6338.C  
'13

**SIZES (mm)**  
75.96  
75.97  
75.98

**Ring Set**  
02.6338  
02.6338  
02.6338  
'13

**Crank Bearing & Seal Kit**  
23.CBS63013  
'14  
  
**Bearing**  
23.NJ206ECP-1  
'13 2x  
23.NJ206ECP-3  
'14 2x

**Con. Rod Kit**  
03.6326  
'13  
03.6333  
'14  
  
**B/E Bearing**  
22.303818F  
'13  
  
**Crankpin**  
06.3053.6  
'13

**Complete**  
34.6326  
'13  
34.6334  
'14  
  
**Top-End**  
35.6326  
'13  
35.6333  
'14  
  
**Head & Base**  
36.6306  
'13  
36.6313  
'14

**Cam Chain**  
31.6328  
'13  
31.6351  
'14  
  
**Valve Shim Assortment**  
29.VSA890  
'13-14  
29.VSA890-2  
'13-14

**Valve**  
28.6326-1  
'13 Exhaust  
Titanium  
28.6326-2  
'13 Intake  
Titanium  
28.6333-1  
'14 Exhaust  
Titanium  
28.6333-2  
'14 Intake  
Titanium  
  
**TI-Steel Conversion Set**  
28.SES6329-1  
'13 Exhaust  
28.SIS6329-2  
'13 Intake  
28.SES6334-1  
'14 Exhaust  
28.SIS6334-2  
'14 Intake  
  
**Valve Seal**  
35.VS028  
'13-14 4x

Please Note:  
Nikasil Piston Size  
-Std. Compression 13.2:1  
-Forged Piston  
-Fuel Injection

**High Compression**  
01.6329.A  
01.6329.B  
'13

**SIZES**  
77.96  
77.97  
77.98

**Ring Set**  
02.6333  
02.6333  
02.6333  
'14

**Pin**  
04.1640.9  
'13  
  
**Clips**  
05.1612C  
'13-14

**STREET**  
APRILIA  
CAGIVA  
HONDA  
KAWASAKI  
KTM  
SUZUKI  
YAMAHA

**ATV-UTV**  
CAN-AM  
GAS GAS  
HONDA  
KAWASAKI  
KTM  
POLARIS  
SUZUKI  
YAMAHA

**PWC**  
KAWASAKI  
POLARIS  
SEA DOO  
YAMAHA

**SNOW**  
ARCTIC CAT  
KAWASAKI  
LYNX  
MOTO-SKI  
POLARIS  
SKI DOO  
YAMAHA

**MOPED & SCOOTER**

**MISC. TECH. SPECIAL**

Footnotes: \* Bearings Only \*\* Rubbers included

**DIRT**  
APRILIA  
BETA  
BMW  
GAS GAS  
HONDA  
HUSABERG  
HUSQVARNA  
KAWASAKI  
KTM  
MOTO TM  
RIEJU  
SHERCO  
SUZUKI  
YAMAHA

**STREET**  
APRILIA  
CAGIVA  
HONDA  
KAWASAKI  
KTM  
SUZUKI  
YAMAHA

**ATV-UTV**  
CAN-AM  
GAS GAS  
HONDA  
KAWASAKI  
KTM  
POLARIS  
SUZUKI  
YAMAHA

**PWC**  
KAWASAKI  
POLARIS  
SEA DOO  
YAMAHA

**SNOW**  
ARCTIC CAT  
KAWASAKI  
LYNX  
MOTO-SKI  
POLARIS  
SKI DOO  
YAMAHA

**MOPED & SCOOTER**

**MISC. TECH. SPECIAL**

**Air Filter**  
52.62011  
'13-14  
  
**Throttle Cable**  
53.110045  
'13-14  
  
**Oil Filter**  
54.63655  
'13 1-Pce.  
54.63655-50  
'13 50-Pcs.  
54.63652  
'14 1-Pce.  
54.63652-50  
'14 50-Pcs.

**Basket**  
17.6326F \*  
'13  
  
**Clutch Rubber Set**  
17.CRS1287-8  
'13  
  
**Inner Hub**  
18.1337  
'13  
  
**Pressure Plate**  
18.P1308  
'13  
  
**Spring Kit**  
17.CS12002  
'13  
  
**Cover Gasket**  
19.G6325  
'13  
  
**Master Cylinder Rebuild Kit**  
16.940000  
'13-14  
  
**Slave Cylinder Rebuild Kit**  
16.950002  
'13  
16.950001  
'14

**Complete Plate Set**  
16.CPS63006  
'13  
  
**Friction Set**  
16.S13013  
'13  
16.S63011  
'14  
  
**Steel Set**  
16.S13014  
'13  
16.S53029  
'14

**F/W Bearing**  
23.S114002  
'13-14  
  
**R/W Bearing**  
23.S112073  
'13-14  
  
**F/W Spacer Kit**  
26.710087  
'13-14  
  
**R/W Spacer Kit**  
26.710084  
'13-14  
  
**Steering Bearing**  
24.110026  
'13-14

**Frontbrake Disc**  
37.BD16290  
'13-14  
  
**Rearbrake Disc**  
37.BD26190  
'13-14  
  
**Front Pad Set**  
37.102202  
'13-14  
37.102202BX  
'13-14 Box of 10  
  
**Rear Pad Set**  
37.202302  
'13-14  
37.202302BX  
'13-14 Box of 10  
  
**Front Caliper Rebuild Kit**  
37.63046  
'13-14  
  
**Rear Caliper Rebuild Kit**  
37.63048  
'13-14  
  
**Front Master Cylinder Rebuild Kit**  
37.910026  
'13  
37.910024  
'14  
  
**Rear Master Cylinder Rebuild Kit**  
37.910030  
'13-14  
  
**Brake Pedal Rebuild Kit**  
37.RBPK001  
'13-14

**Front Sprocket**  
07.FS62093-12  
07.FS62093-13  
07.FS62093-14  
07.FS62093-15  
'13-14  
  
**7075-T6 Alloy Rear Sprocket**  
07.RA62090-48  
07.RA62090-49  
07.RA62090-50  
07.RA62090-51  
07.RA62090-52  
'13-14  
  
**UltraLight Steel Rear Sprocket**  
07.RS62090R-48  
07.RS62090R-49  
07.RS62090R-50  
07.RS62090R-51  
07.RS62090R-52  
'13-14  
  
**Sprocket Bolt Set**  
07.SBSM825  
'13-14

**Chain**  
07.RC520120C  
'13-14 MX  
07.RC520120CG  
'13-14 MX Gold  
07.RC520120XC  
'13-14 X-Ring  
07.RC520120XCG  
'13-14 X-Ring Gold  
  
**Countershaft Seal Kit**  
26.640001  
'13-14

**Swingarm**  
26.210168  
'13-14  
  
**Upper**  
26.350059  
'13-14  
  
**Lower**  
26.410089  
'13-14

**Bushing Set**  
39.160122  
'14  
  
**Rear Shock Seal Head Kit**  
26.810119  
'13-14





**HUSABERG**

**DIRT**

TE 300  
2-Stroke  
Please Note:  
Nikasil Piston Size

<b>Piston Kit</b> 01.6394.A 01.6394.B 01.6394.C '11-14	<b>Size</b> 71.94 71.95 71.96	<b>Ring Set</b> 02.6394 02.6394 02.6394 '11-14	<b>Crank Bearing &amp; Seal Kit</b> 23.CBS63004 '11-14	<b>Con. Rod Kit</b> 03.6323 '11-14	<b>Complete</b> 34.6348 '11-14
<b>Bearing</b> 23.NJ207ECS '11-14 Left 23.6232X2 '11-14 Right	<b>S/E Bearing</b> 21.6320 '11-14	<b>Top-End</b> 35.6348 '11-14	<b>B/E Bearing</b> 22.243017F '11-14	<b>Head &amp; Base</b> 36.6308 '11-14	<b>Ignition Cover Gasket</b> 19.G96308 '11-14
<b>Clips</b> 05.1815 '11-14	<b>Oilseal Set</b> 42.6320 '11-14	<b>Crankpin</b> 06.2459.6 '11-14			

**STREET**

APRILIA  
CAGIVA  
HONDA  
KAWASAKI  
KTM  
SUZUKI  
YAMAHA

--	--	--	--	--	--

**ATV-UTV**

CAN-AM  
GAS GAS  
HONDA  
KAWASAKI  
KTM  
POLARIS  
SUZUKI  
YAMAHA

--	--	--	--	--	--

**PWC**

KAWASAKI  
POLARIS  
SEA DOO  
YAMAHA

--	--	--	--	--	--

**SNOW**

ARCTIC CAT  
KAWASAKI  
LYNX  
MOTO-SKI  
POLARIS  
SKI DOO  
YAMAHA

--	--	--	--	--	--

**MOPED & SCOOTER**

--	--	--	--	--	--

**MISC. TECH. SPECIAL**

--	--	--	--	--	--

Footnotes: \* Bearings Only \*\* Rubbers included

<b>Air Filter</b> 52.62010 '11-12 52.62011 '13-14	<b>Basket</b> 17.6323F '11-12	<b>Complete Plate Set</b> 16.CPS64012 '13-14	<b>F/W Bearing</b> 23.S114002 '11-14	<b>Frontbrake Disc</b> 37.BD16290 '11-14	<b>Front Sprocket</b> 07.FS62093-12 07.FS62093-13 07.FS62093-14 07.FS62093-15 '11-14	<b>Chain</b> 07.RC520120C '11-14 MX 07.RC520120CG '11-14 MX Gold 07.RC520120XC '11-14 X-Ring 07.RC520120XCG '11-14 X-Ring Gold	<b>Swingarm</b> 26.210168 '11-14	<b>Seal &amp; Wiper</b> 40.S4857.89 '11-12
<b>Main Jet</b> 45.100-45.225 '11-14 Keihin	<b>Spring Kit</b> 17.CS63011 '11-12	<b>Friction Set</b> 16.S53014 '11-12	<b>R/W Bearing</b> 23.S112073 '11-14	<b>Rearbrake Disc</b> 37.BD26190 '11-14	<b>7075-T6 Alloy Rear Sprocket</b> 07.RA62090-48 07.RA62090-49 07.RA62090-50 07.RA62090-51 07.RA62090-52 '11-14	<b>Upper</b> 26.350059 '11-14	<b>Oil Seal Set</b> 40.F4857.89 '11-12	
<b>Carburetor Rebuild Kit</b> 55.10514 '11-14	<b>Inner Cover / Case Gasket</b> 19.G6323 '11-14	<b>Steel Set</b> 16.S53015 '11-12 16.S53029 '13-14	<b>F/W Spacer Kit</b> 26.710087 '11-14	<b>Front Pad Set</b> 37.102202 '11-14 37.102202BX '11-14 Box of 10	<b>Countershaft Seal Kit</b> 26.640003 '11-14	<b>Lower</b> 26.410089 '11-14	<b>Dust Seal Set</b> 40.F4857.8D '11-12	
<b>Pilot Jet</b> 46.040-46.085 '11-14 Keihin	<b>Cover Gasket</b> 19.G6324 '11-14		<b>R/W Spacer Kit</b> 26.710084 '11-14	<b>Rear Pad Set</b> 37.202302 '11-14 37.202302BX '11-14 Box of 10	<b>Ultralight Steel Rear Sprocket</b> 07.RS62090R-48 07.RS62090R-49 07.RS62090R-50 07.RS62090R-51 07.RS62090R-52 '11-14	<b>Bushing Set</b> 39.160074 '11 39.160082 '12 39.160122 '14	<b>Rear Shock Seal Head Kit</b> 26.810119 '11-14	
<b>Throttle Cable</b> 53.110046 '11-14	<b>Master Cylinder Rebuild Kit</b> 16.940000 '11-14	<b>Slave Cylinder Rebuild Kit</b> 16.950000 '11-14	<b>Steering Bearing</b> 24.110026 '11-14	<b>Front Caliper Rebuild Kit</b> 37.63046 '11-14	<b>Sprocket Bolt Set</b> 07.SBSM825 '11-14			
				<b>Rear Caliper Rebuild Kit</b> 37.63048 '11-14				
				<b>Front Master Cylinder Rebuild Kit</b> 37.910026 '11-13				
				<b>Rear Master Cylinder Rebuild Kit</b> 37.910028 '11 37.910030 '12-14				
				<b>Brake Pedal Rebuild Kit</b> 37.RBPK001 '11-14				

**DIRT**

**STREET**

**ATV-UTV**

**PWC**

**SNOW**

**MOPED & SCOOTER**

**MISC. TECH. SPECIAL**



**HUSABERG**

**DIRT**  
APRILIA  
BETA  
BMW  
GAS GAS  
HONDA  
HUSABERG  
HUSQVARNA  
KAWASAKI  
KTM  
MOTO TM  
RIEJU  
SHERCO  
SUZUKI  
YAMAHA

**STREET**  
APRILIA  
CAGIVA  
HONDA  
KAWASAKI  
KTM  
SUZUKI  
YAMAHA

**ATV-UTV**  
CAN-AM  
GAS GAS  
HONDA  
KAWASAKI  
KTM  
POLARIS  
SUZUKI  
YAMAHA

**PWC**  
KAWASAKI  
POLARIS  
SEA DOO  
YAMAHA

**SNOW**  
ARCTIC CAT  
KAWASAKI  
LYNX  
MOTO-SKI  
POLARIS  
SKI DOO  
YAMAHA

**MOPED & SCOOTER**

**MISC. TECH. SPECIAL**

FE 350 4-Stroke Please Note: Nikasil Piston Size -Std. Compression 12.3:1 -Forged Piston -Fuel Injection	<b>Piston Kit</b> 01.6362.A 01.6362.B 01.6362.C '13-14	<b>Size</b> 87.96 87.97 87.98	<b>Ring Set</b> 02.6351 02.6351 02.6351 '13-14 <b>Pin</b> 04.1844.4 '13-14 <b>Clips</b> 05.1812 '13-14	<b>Crank Bearing &amp; Seal Kit</b> 23.CBS63013 '13-14 <b>Bearing</b> 23.NJ206ECP-3 '13-14 2x <b>Oilseal Set</b> 42.6351 '13-14	<b>Con. Rod Kit</b> 03.6351 '13 03.6363 '14 <b>B/E Bearing</b> 22.324020F '13 <b>Crankpin</b> 06.3259.9 '13	<b>Head &amp; Base</b> 36.6311 '13-14	<b>Cam Chain</b> 31.6351 '13-14 <b>Valve Shim Assortment</b> 29.VSA890 '13-14 29.VSA890-2 '13-14	<b>Valve</b> 28.6351-1 '13-14 2x Exhaust Titanium 28.6351-2 '13-14 2x Intake Titanium <b>TI-Steel Conversion Set</b> 28.SES6353-1 '13 Exhaust 28.SIS6353-2 '13 Intake
FE 390 4-Stroke Please Note: Nikasil Piston Size -Std. Compression 11.1:1 -Forged Piston -Fuel Injection	<b>Piston Kit</b> 01.6439.A 01.6439.B 01.6439.C '10-12	<b>Size</b> 94.94 94.95 94.96	<b>Ring Set</b> 02.6429 02.6429 02.6429 '10-12 <b>Pin</b> 04.1947.5 '10-12 <b>Clips</b> 05.1912 '10-12	<b>Oilseal Set</b> 42.6432 '10-12			<b>Cam Chain</b> 31.6428 '10-12 <b>Valve Shim Assortment</b> 29.VSA1000 '10-12 29.VSA1000-2 '10-12	<b>Valve</b> 28.6428-1 '10-12 2x Exhaust Steel 28.6428-2 '10-12 2x Intake Titanium

Footnotes: \* Bearings Only \*\* Rubbers included

<b>Air Filter</b> 52.62011 '13-14 <b>Throttle Cable</b> 53.110045 '13-14 <b>Oil Filter</b> 54.63652 '13-14 1-Pce. 54.63652-50 '13-14 50-Pcs.	<b>Cover Gasket</b> 19.G6351 '13-14 <b>Master Cylinder Rebuild Kit</b> 16.940000 '13-14 <b>Slave Cylinder Rebuild Kit</b> 16.950000 '13-14	<b>Complete Plate Set</b> 16.CPS64012 '13-14 <b>Friction Set</b> 16.S53011 '13-14 <b>Steel Set</b> 16.S53029 '13-14	<b>F/W Bearing</b> 23.S114002 '13-14 <b>R/W Bearing</b> 23.S112073 '13-14 <b>F/W Spacer Kit</b> 26.710087 '13-14 <b>R/W Spacer Kit</b> 26.710084 '13-14 <b>Steering Bearing</b> 24.110026 '13-14	<b>Frontbrake Disc</b> 37.BD16290 '13-14 <b>Rearbrake Disc</b> 37.BD26190 '13-14 <b>Front Pad Set</b> 37.102202 '13-14 37.102202BX '13-14 Box of 10 <b>Rear Pad Set</b> 37.202302 '13-14 37.202302BX '13-14 Box of 10 <b>Front Caliper Rebuild Kit</b> 37.63046 '13-14 <b>Rear Caliper Rebuild Kit</b> 37.63048 '13-14 <b>Front Master Cylinder Rebuild Kit</b> 37.910026 '13 37.910035 '14 <b>Rear Master Cylinder Rebuild Kit</b> 37.910030 '13-14 <b>Brake Pedal Rebuild Kit</b> 37.RBPK001 '13-14	<b>Front Sprocket</b> 07.FS62093-12 07.FS62093-13 07.FS62093-14 07.FS62093-15 '13-14 <b>7075-T6 Alloy Rear Sprocket</b> 07.RA62090-48 07.RA62090-49 07.RA62090-50 07.RA62090-51 07.RA62090-52 '13-14 <b>Ultralight Steel Rear Sprocket</b> 07.RS62090R-48 07.RS62090R-49 07.RS62090R-50 07.RS62090R-51 07.RS62090R-52 '13-14 <b>Sprocket Bolt Set</b> 07.SBSM825 '13-14	<b>Chain</b> 07.RC520120C '13-14 MX 07.RC520120CG '13-14 MX Gold 07.RC520120XC '13-14 X-Ring 07.RC520120XCG '13-14 X-Ring Gold <b>Countershaft Seal Kit</b> 26.640001 '13-14	<b>Swingarm</b> 26.210168 '13-14 <b>Upper</b> 26.350059 '13-14 <b>Lower</b> 26.410089 '13-14	<b>Bushing Set</b> 39.160122 '14 <b>Rear Shock Seal Head Kit</b> 26.810119 '13-14
<b>Air Filter</b> 52.63009 '10-12 <b>Oil Filter</b> 54.63655 '10-12 1-Pce. 54.63655-50 '10-12 50-Pcs.	<b>Basket</b> 17.6427F * '10-12 <b>Clutch Rubber Set</b> 17.CRS1386-8 '10-12 <b>Spring Kit</b> 17.CS64049 '10-12 <b>Master Cylinder Rebuild Kit</b> 16.940003 '10-11 <b>Slave Cylinder Rebuild Kit</b> 16.950009 '10-11	<b>Complete Plate Set</b> 16.CPS64010 '10-12 <b>Friction Set</b> 16.S54017 '10-12 <b>Steel Set</b> 16.S54021 '10-12	<b>F/W Bearing</b> 23.S114002 '10-12 <b>R/W Bearing</b> 23.S112073 '10-12 <b>F/W Spacer Kit</b> 26.710087 '10-12 <b>R/W Spacer Kit</b> 26.710084 '10-12 <b>Steering Bearing</b> 24.110026 '10-12	<b>Frontbrake Disc</b> 37.BD16290 '10-12 <b>Rearbrake Disc</b> 37.BD26190 '10-12 <b>Front Pad Set</b> 37.102202 '10-12 37.102202BX '10-12 Box of 10 <b>Rear Pad Set</b> 37.202302 '10-12 37.202302BX '10-12 Box of 10 <b>Front Caliper Rebuild Kit</b> 37.63046 '10-11 <b>Rear Caliper Rebuild Kit</b> 37.63048 '10-11 <b>Front Master Cylinder Rebuild Kit</b> 37.910026 '10-11 <b>Rear Master Cylinder Rebuild Kit</b> 37.910028 '10-11 <b>Brake Pedal Rebuild Kit</b> 37.RBPK001 '10-12	<b>Front Sprocket</b> 07.FS62093-12 07.FS62093-13 07.FS62093-14 07.FS62093-15 '10-12 <b>7075-T6 Alloy Rear Sprocket</b> 07.RA62090-48 07.RA62090-49 07.RA62090-50 07.RA62090-51 07.RA62090-52 '10-12 <b>Ultralight Steel Rear Sprocket</b> 07.RS62090R-48 07.RS62090R-49 07.RS62090R-50 07.RS62090R-51 07.RS62090R-52 '10-12 <b>Sprocket Bolt Set</b> 07.SBSM825 '10-12	<b>Chain</b> 07.RC520120C '10-12 MX 07.RC520120CG '10-12 MX Gold 07.RC520120XC '10-12 X-Ring 07.RC520120XCG '10-12 X-Ring Gold <b>Countershaft Seal Kit</b> 26.640001 '10-12	<b>Swingarm</b> 26.210125 '10-12 <b>Upper</b> 26.350059 '10-12 <b>Lower</b> 26.410089 '10-12	<b>Seal &amp; Wiper</b> 40.S4857.89 '10-12 <b>Oil Seal Set</b> 40.F4857.89 '10-12 <b>Dust Seal Set</b> 40.F4857.8D '10-12 <b>Bushing Set</b> 39.160074 '10-12 <b>Rear Shock Seal Head Kit</b> 26.810119 '10-12

**DIRT**  
APRILIA  
BETA  
BMW  
GAS GAS  
HONDA  
HUSABERG  
HUSQVARNA  
KAWASAKI  
KTM  
MOTO TM  
RIEJU  
SHERCO  
SUZUKI  
YAMAHA

**STREET**  
APRILIA  
CAGIVA  
HONDA  
KAWASAKI  
KTM  
SUZUKI  
YAMAHA

**ATV-UTV**  
CAN-AM  
GAS GAS  
HONDA  
KAWASAKI  
KTM  
POLARIS  
SUZUKI  
YAMAHA

**PWC**  
KAWASAKI  
POLARIS  
SEA DOO  
YAMAHA

**SNOW**  
ARCTIC CAT  
KAWASAKI  
LYNX  
MOTO-SKI  
POLARIS  
SKI DOO  
YAMAHA

**MOPED & SCOOTER**

**MISC. TECH. SPECIAL**





### HUSABERG

**DIRT**  
APRILIA  
BETA  
BMW  
GAS GAS  
HONDA  
HUSABERG  
HUSQVARNA  
KAWASAKI  
KTM  
MOTO TM  
RIEJU  
SHERCO  
SUZUKI  
YAMAHA

FE 450 4-Stroke Please Note: Nikasil Piston Size -Std. Compression 13.0:1 -Forged Piston	<b>Piston Kit</b> 01.6403.A 01.6403.B 01.6403.C '04-08	<b>Size (mm)</b> 99.94 99.95 99.96	<b>Ring Set</b> 02.6508 02.6508 02.6508 '04-08	<b>CrankBearing &amp; Seal Kit</b> 23.CBS64012 '13-14	<b>Con. Rod Kit</b> 03.6428 '09-12 03.6433 '14	<b>Complete</b> 34.6512 '13 34.6413 '14	<b>Cam Chain</b> 31.6428 '09-14	<b>Valve</b> 28.6520-1 '04-08 2x Exhaust Steel 28.6520-2 '04-08 2x Intake Steel 28.6428-1 '09-14 2x Exhaust Steel 28.6428-2 '09-13 2x Intake Titanium 28.6433-2 '14 2x Intake Titanium
Please Note: Nikasil Piston Size -Std. Compression 11.9:1 -Forged Piston -Fuel Injection	01.6429.A 01.6429.B 01.6429.C '09-12	94.94 94.95 94.96	02.6429 02.6429 02.6429 '09-12	<b>Bearing</b> 23.SX07E39 '13-14 2x	<b>B/E Bearing</b> 22.354220F '09-13	<b>Top-End</b> 35.6438 '09-11	<b>Valve Shim Assortment</b> 29.VSA1000 '09-13 29.VSA1000-2 '09-13 29.VSA890 '14 29.VSA890-2 '14	
Please Note: Nikasil Piston Size -Std. Compression 11.9:1 -Forged Piston -Fuel Injection	01.6432.A 01.6432.B 01.6432.C '13-14	94.94 94.95 94.96	02.6429 02.6429 02.6429 '13-14	<b>Oilseal Set</b> 42.6432 '09-14	<b>Crankpin</b> 06.3562.7 '09-13	<b>Head &amp; Base</b> 36.6414 '14	<b>Ignition Cover Gasket</b> 19.G96433 '13-14	
			<b>Pin</b> 04.2050.5 '04-08 04.1947.5 '09-14					
			<b>Clips</b> 05.2012 '04-08 05.1912 '09-14					

Footnotes: \* Bearings Only \*\* Rubbers included

<b>Air Filter</b> 52.64004 '04-08 52.63009 '09-12 52.62011 '13-14	<b>Basket</b> 17.6427F * '09-12	<b>Complete Plate Set</b> 16.CPS64004 '04-08 16.CPS64009 '09 16.CPS64010 '10-12 16.CPS64012 '13-14	<b>F/W Bearing</b> 23.S114002 '04-14	<b>Frontbrake Disc</b> 37.BD16290 '04-14	<b>Front Sprocket</b> 07.FS62093-12 07.FS62093-13 07.FS62093-14 07.FS62093-15 '09-14	<b>Chain</b> 07.RC520120C '04-14 MX 07.RC520120CG '04-14 MX Gold 07.RC520120XC '04-14 X-Ring 07.RC520120XCG '04-14 X-Ring Gold	<b>Swingarm</b> 26.210178 '04 26.210179 '05-08 26.210125 '09-14	<b>Seal &amp; Wiper</b> 40.S4857.89 '04-12
<b>Throttle Cable</b> 53.110043 '04-08 53.110045 '14	<b>Clutch Rubber Set</b> 17.CRS1386-8 '09-12	<b>Friction Set</b> 16.S54007 '04-08 16.S54017 '09-12 16.S53011 '13-14	<b>F/W Spacer Kit</b> 26.710087 '04-14	<b>Rearbrake Disc</b> 37.BD26190 '09-14	<b>7075-T6 Alloy Rear Sprocket</b> 07.RA62090-48 07.RA62090-49 07.RA62090-50 07.RA62090-51 07.RA62090-52 '04-14	<b>Lower Chain Roller</b> 33.0003 '04-08	<b>Upper</b> 26.350059 '09-14	<b>Oil Seal Set</b> 40.F4857.89 '04-12
<b>Carburetor Rebuild Kit</b> 55.10521 '04-08	<b>Spring Kit</b> 17.CS65041 '04-08 17.CS64049 '09-12	<b>Steel Set</b> 16.S54009 '04-08 16.S54020 '09 16.S54021 '10-12 16.S53029 '13-14	<b>R/W Spacer Kit</b> 26.710084 '04-14	<b>Front Pad Set</b> 37.102202 '04-14 37.102202BX '04-14 Box of 10	<b>UltraLight Steel Rear Sprocket</b> 07.RS62090R-48 07.RS62090R-49 07.RS62090R-50 07.RS62090R-51 07.RS62090R-52 '04-14	<b>Upper Chain Roller</b> 33.0003 '04-08	<b>Lower</b> 26.450056 '04-08 26.410089 '09-14	<b>Dust Seal Set</b> 40.F4857.8D '04-12
<b>Oil Filter</b> 54.63655 '04-14 1-Pce. 54.63655-50 '04-14 50-Pcs.	<b>Master Cylinder Rebuild Kit</b> 16.940001 '04-08 16.940003 '09-11 16.940000 '14		<b>Steering Bearing</b> 24.110032 '04-08 24.110026 '09-14	<b>Rear Pad Set</b> 37.204202 '04-07 37.204202BX '04-07 Box of 10 37.202302 '08-14 37.202302BX '08-14 Box of 10				<b>Bushing Set</b> 39.160077 '04 39.160054 '05-08 39.160074 '09-12 39.160122 '14
				<b>Front Caliper Rebuild Kit</b> 37.63047 '06-08 37.63046 '09-11 37.63046 '14				<b>Rear Shock Seal Head Kit</b> 26.810119 '04-14
				<b>Rear Caliper Rebuild Kit</b> 37.63048 '06-08 37.63048 '09-11 37.63048 '14				
				<b>Front Master Cylinder Rebuild Kit</b> 37.910023 '06-08 37.910026 '09-11				
				<b>Brake Pedal Rebuild Kit</b> 37.RBPK001 '09-14				

**DIRT**  
APRILIA  
BETA  
BMW  
GAS GAS  
HONDA  
HUSABERG  
HUSQVARNA  
KAWASAKI  
KTM  
MOTO TM  
RIEJU  
SHERCO  
SUZUKI  
YAMAHA

**STREET**  
APRILIA  
CAGIVA  
HONDA  
KAWASAKI  
KTM  
SUZUKI  
YAMAHA

**ATV-UTV**  
CAN-AM  
GAS GAS  
HONDA  
KAWASAKI  
KTM  
POLARIS  
SUZUKI  
YAMAHA

**PWC**  
KAWASAKI  
POLARIS  
SEA DOO  
YAMAHA

**SNOW**  
ARCTIC CAT  
KAWASAKI  
LYNX  
MOTO-SKI  
POLARIS  
SKI DOO  
YAMAHA

**MOPED & SCOOTER**

**MISC. TECH. SPECIAL**



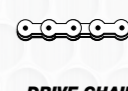

### HUSABERG

#### DIRT

- APRILIA
- BETA
- BMW
- GAS GAS
- HONDA
- HUSABERG
- HUSQVARNA
- KAWASAKI
- KTM
- MOTO TM
- RIEJU
- SHERCO
- SUZUKI
- YAMAHA

FX 450 4-Stroke Please Note: Nikasil Piston Size -Std. Compression 11.8:1 -Forged Piston -Fuel Injection	<b>Piston Kit</b> 01.6429.A 01.6429.B 01.6429.C '10-12	<b>Size</b> 94.94 94.95 94.96	<b>Ring Set</b> 02.6429 02.6429 02.6429 '10-12	<b>Oilseal Set</b> 42.6432 '10-11	<b>Con. Rod Kit</b> 03.6428 '10-12	<b>Top-End</b> 35.6438 '10-11	<b>Cam Chain</b> 31.6428 '10-12	<b>Valve</b> 28.6428-1 '10-12 2x Exhaust Steel 28.6428-2 '10-12 2x Intake Titanium
			<b>Pin</b> 04.1947.5 '10-12		<b>B/E Bearing</b> 22.354220F '10-12		<b>Valve Shim Assortment</b> 29.VSA1000 '10-12	
			<b>Clips</b> 05.1912 '10-12		<b>Crankpin</b> 06.3562.7 '10-12		<b>29.VSA1000-2</b> '10-12	

#### STREET

- APRILIA
- CAGIVA
- HONDA
- KAWASAKI
- KTM
- SUZUKI
- YAMAHA

#### ATV-UTV

- CAN-AM
- GAS GAS
- HONDA
- KAWASAKI
- KTM
- POLARIS
- SUZUKI
- YAMAHA

#### PWC

- KAWASAKI
- POLARIS
- SEA DOO
- YAMAHA

#### SNOW

- ARCTIC CAT
- KAWASAKI
- LYNX
- MOTO-SKI
- POLARIS
- SKI DOO
- YAMAHA

#### MOPED & SCOOTER

#### MISC. TECH. SPECIAL

FE 501 4-Stroke Please Note: Nikasil Piston Size -Std. Compression 11.8:1 -Forged Piston -Fuel Injection	<b>Piston Kit</b> 01.6512.A 01.6512.B 01.6512.C '13-14	<b>Size</b> 94.95 94.96 94.97	<b>Ring Set</b> 02.6429 02.6429 02.6429 '13-14	<b>Crank Bearing &amp; Seal Kit</b> 23.CBS64012 '13-14	<b>Con. Rod Kit</b> 03.6512 '13	<b>Head &amp; Base</b> 36.6414 '14	<b>Cam Chain</b> 31.6508 '13-14	<b>Valve</b> 28.6428-1 '13-14 2x Exhaust Steel 28.6428-2 '13 2x Intake Titanium 28.6433-2 '14 2x Intake Titanium <b>Valve Seal</b> 35.VS026 '13-14 2x Intake
			<b>Pin</b> 04.1947.5 '13-14	<b>Bearing</b> 23.SX07E39 '13-14 2x	<b>B/E Bearing</b> 22.354220F '13		<b>Valve Shim Assortment</b> 29.VSA1000 '13	
			<b>Clips</b> 05.1912 '13-14	<b>Oilseal Set</b> 42.6432 '13-14	<b>Crankpin</b> 06.3562.7 '13		<b>29.VSA890</b> '14	
					<b>29.VSA890-2</b> '14			

Footnotes: \* Bearings Only \*\* Rubbers included

<b>Air Filter</b> 52.63009 '10-12	<b>Basket</b> 17.6427F '10-12	<b>Complete Plate Set</b> 16.CPS64010 '10-12	<b>F/W Bearing</b> 23.S114002 '10-12	<b>Frontbrake Disc</b> 37.BD16290 '10-12	<b>Front Sprocket</b> 07.FS62093-12 07.FS62093-13 07.FS62093-14 07.FS62093-15 '10-12	<b>Chain</b> 07.RC520120C '10-12 MX 07.RC520120CG '10-12 MX Gold 07.RC520120XC '10-12 X-Ring 07.RC520120XCG '10-12 X-Ring Gold	<b>Swingarm</b> 26.210125 '10-12	<b>Seal &amp; Wiper</b> 40.S4857.89 '10-12
<b>Oil Filter</b> 54.63655 '10-12 1-Pce. 54.63655-50 '10-12 50-Pcs.	<b>Clutch Rubber Set</b> 17.CRS1386-8 '10-12	<b>Friction Set</b> 16.S54017 '10-12	<b>R/W Bearing</b> 23.S112073 '10-12	<b>Rearbrake Disc</b> 37.BD26190 '10-12	<b>7075-T6 Alloy Rear Sprocket</b> 07.RA62090-48 07.RA62090-49 07.RA62090-50 07.RA62090-51 07.RA62090-52 '10-12	<b>Countershaft Seal Kit</b> 26.640001 '10-12	<b>Upper</b> 26.350059 '10-12	<b>Oil Seal Set</b> 40.F4857.89 '10-12
	<b>Spring Kit</b> 17.CS64049 '10-12	<b>Steel Set</b> 16.S54021 '10-12	<b>F/W Spacer Kit</b> 26.710087 '10-12	<b>Front Pad Set</b> 37.102202 '10-12		<b>Lower</b> 26.410089 '10-12	<b>Dust Seal Set</b> 40.F4857.8D '10-12	
	<b>Master Cylinder Rebuild Kit</b> 16.940003 '10-11		<b>R/W Spacer Kit</b> 26.710084 '10-12	<b>Front Pad Set</b> 37.102202BX '10-12 Box of 10			<b>Bushing Set</b> 39.160074 '10-12	
			<b>Steering Bearing</b> 24.110026 '10-12	<b>Rear Pad Set</b> 37.202302 '10-12	<b>Ultralight Steel Rear Sprocket</b> 07.RS62090R-48 07.RS62090R-49 07.RS62090R-50 07.RS62090R-51 07.RS62090R-52 '10-12	<b>Sprocket Bolt Set</b> 07.SBSM825 '10-12	<b>Rear Shock Seal Head Kit</b> 26.810119 '10-12	
				<b>Front Caliper Rebuild Kit</b> 37.63046 '10-11				
				<b>Rear Caliper Rebuild Kit</b> 37.63048 '10-11				
				<b>Front Master Cylinder Rebuild Kit</b> 37.910026 '10-11				
				<b>Rear Master Cylinder Rebuild Kit</b> 37.910028 '10-11				
				<b>Brake Pedal Rebuild Kit</b> 37.RBPK001 '10-12				

#### DIRT

- APRILIA
- BETA
- BMW
- GAS GAS
- HONDA
- HUSABERG
- HUSQVARNA
- KAWASAKI
- KTM
- MOTO TM
- RIEJU
- SHERCO
- SUZUKI
- YAMAHA

#### STREET

- APRILIA
- CAGIVA
- HONDA
- KAWASAKI
- KTM
- SUZUKI
- YAMAHA

#### ATV-UTV

- CAN-AM
- GAS GAS
- HONDA
- KAWASAKI
- KTM
- POLARIS
- SUZUKI
- YAMAHA

#### PWC

- KAWASAKI
- POLARIS
- SEA DOO
- YAMAHA

#### SNOW

- ARCTIC CAT
- KAWASAKI
- LYNX
- MOTO-SKI
- POLARIS
- SKI DOO
- YAMAHA

#### MOPED & SCOOTER

#### MISC. TECH. SPECIAL





### HUSABERG

#### DIRT

- APRILIA
- BETA
- BMW
- GAS GAS
- HONDA
- HUSABERG
- HUSQVARNA
- KAWASAKI
- KTM
- MOTO TM
- RIEJU
- SHERCO
- SUZUKI
- YAMAHA

FE 550 4-Stroke Please Note: Nikasil Piston Size -Std. Compression 11.8:1 -Forged Piston	<b>Piston Kit</b> 01.6503.A 01.6503.B 01.6503.C '04-08	<b>Size</b> 99.95 99.96 99.97	<b>Ring Set</b> 02.6508 02.6508 02.6508 '04-08	<b>Bearing</b> 23.NJ206ECP-1 '04-08 2x			<b>Valve</b> 28.6520-1 '04-08 2x Exhaust Steel 28.6520-2 '04-08 2x Intake Steel
			<b>Clips</b> 05.2012 '04-08				

#### STREET

- APRILIA
- CAGIVA
- HONDA
- KAWASAKI
- KTM
- SUZUKI
- YAMAHA

#### ATV-UTV

- CAN-AM
- GAS GAS
- HONDA
- KAWASAKI
- KTM
- POLARIS
- SUZUKI
- YAMAHA

#### PWC

- KAWASAKI
- POLARIS
- SEA DOO
- YAMAHA

#### SNOW

- ARCTIC CAT
- KAWASAKI
- LYNX
- MOTO-SKI
- POLARIS
- SKI DOO
- YAMAHA

#### MOPED & SCOOTER

#### MISC. TECH. SPECIAL

FE 570 4-Stroke Please Note: Nikasil Piston Size -Std. Compression 11.8:1 -Forged Piston -Fuel Injection	<b>Piston Kit</b> 01.6519.A 01.6519.B 01.6519.C '09-12	<b>Size</b> 99.95 99.96 99.97	<b>Ring Set</b> 02.6508 02.6508 02.6508 '09-12	<b>Oilseal Set</b> 42.6432 '09-12		<b>Cam Chain</b> 31.6508 '09-12	<b>Valve</b> 28.6428-1 '09-12 2x Exhaust Steel 28.6428-2 '09-12 2x Intake Titanium
			<b>Clips</b> 05.2012 '09-12			<b>Valve Shim Assortment</b> 29.VSA1000 '09-12 29.VSA1000-2 '09-12	

Footnotes: \* Bearings Only \*\* Rubbers included

<b>Air Filter</b> 52.64004 '04-08	<b>Spring Kit</b> 17.CS65041 '04-08	<b>Friction Set</b> 16.S54007 '04-08	<b>F/W Bearing</b> 23.S114002 '07-08	<b>Frontbrake Disc</b> 37.BD16290 '04-08	<b>7075-T6 Alloy Rear Sprocket</b> 07.RA62090-48 07.RA62090-49 07.RA62090-50 07.RA62090-51 07.RA62090-52 '04-08	<b>Chain</b> 07.RC520120C '04-08 MX 07.RC520120CG '04-08 MX Gold 07.RC520120XC '04-08 X-Ring 07.RC520120XCG '04-08 X-Ring Gold	<b>Swingarm</b> 26.210179 '07-08	<b>Seal &amp; Wiper</b> 40.S4857.89 '04-08
<b>Main Jet</b> 45.100-225 '04-08 Keihin	<b>Master Cylinder Rebuild Kit</b> 16.940001 '07-08	<b>Steel Set</b> 16.S54009 '04-08	<b>R/W Bearing</b> 23.S112073 '07-08	<b>Front Pad Set</b> 37.102202 '04-08 37.102202BX '04-08 Box of 10	<b>UltraLight Steel Rear Sprocket</b> 07.RS62090R-48 07.RS62090R-49 07.RS62090R-50 07.RS62090R-51 07.RS62090R-52 '04-08	<b>Lower Chain Roller</b> 33.0003 '07-08	<b>Lower</b> 26.450056 '07-08	<b>Oil Seal Set</b> 40.F4857.89 '04-08
<b>Pilot Jet</b> 46.040-085 '04-08 Keihin			<b>F/W Spacer Kit</b> 26.710087 '07-08	<b>Rear Pad Set</b> 37.204202 '04-08 37.204202BX '04-08 Box of 10	<b>Upper Chain Roller</b> 33.0003 '07-08	<b>Dust Seal Set</b> 40.F4857.8D '04-08		<b>Oil Seal Set</b> 40.F4857.89 '04-08
<b>Carburetor Rebuild Kit</b> 55.10521 '07-08			<b>R/W Spacer Kit</b> 26.710084 '07-08	<b>Front Caliper Rebuild Kit</b> 37.63047 '07-08	<b>Sprocket Bolt Set</b> 07.SBSM825 '04-08	<b>Bushing Set</b> 39.160054 '07-08		<b>Oil Seal Set</b> 40.F4857.89 '04-08
<b>Throttle Cable</b> 53.110043 '07-08			<b>Steering Bearing</b> 24.110032 '07-08	<b>Rear Caliper Rebuild Kit</b> 37.63048 '07-08		<b>Rear Shock Seal Head Kit</b> 26.810119 '07-08		<b>Oil Seal Set</b> 40.F4857.89 '04-08
<b>Oil Filter</b> 54.63655 '04-08 1-Pce. 54.63655-50 '04-08 50-Pcs.				<b>Front Master Cylinder Rebuild Kit</b> 37.910023 '07-08				<b>Oil Seal Set</b> 40.F4857.89 '04-12
				<b>Rear Master Cylinder Rebuild Kit</b> 37.910029 '07-08				<b>Oil Seal Set</b> 40.F4857.89 '04-12

#### DIRT

- APRILIA
- BETA
- BMW
- GAS GAS
- HONDA
- HUSABERG
- HUSQVARNA
- KAWASAKI
- KTM
- MOTO TM
- RIEJU
- SHERCO
- SUZUKI
- YAMAHA

#### STREET

- APRILIA
- CAGIVA
- HONDA
- KAWASAKI
- KTM
- SUZUKI
- YAMAHA

#### ATV-UTV

- CAN-AM
- GAS GAS
- HONDA
- KAWASAKI
- KTM
- POLARIS
- SUZUKI
- YAMAHA

#### PWC

- KAWASAKI
- POLARIS
- SEA DOO
- YAMAHA

#### SNOW

- ARCTIC CAT
- KAWASAKI
- LYNX
- MOTO-SKI
- POLARIS
- SKI DOO
- YAMAHA

#### MOPED & SCOOTER

#### MISC. TECH. SPECIAL





### HUSABERG

**DIRT**  
APRILIA  
BETA  
BMW  
GAS GAS  
HONDA  
HUSABERG  
HUSQVARNA  
KAWASAKI  
KTM  
MOTO TM  
RIEJU  
SHERCO  
SUZUKI  
YAMAHA

FE 650 4-Stroke Please Note: Nikasil Piston Size -Std. Compression 11.8:1 -Forged Piston	<b>Piston Kit</b> 01.6606.A 01.6606.B 01.6606.C '04-08	<b>Size</b> 99.95 99.96 99.97	<b>Ring Set</b> 02.6508 02.6508 02.6508 '04-08	<b>Bearing</b> 23.NJ206ECP-1 '04-08 2x				<b>Valve</b> 28.6520-1 '04-08 2x Exhaust Steel 28.6520-2 '04-08 2x Intake Steel
			<b>Clips</b> 05.2012 '04-08					

**STREET**  
APRILIA  
CAGIVA  
HONDA  
KAWASAKI  
KTM  
SUZUKI  
YAMAHA

FS 650 4-Stroke Please Note: Nikasil Piston Size -Std. Compression 11.8:1 -Forged Piston	<b>Piston Kit</b> 01.6606.A 01.6606.B 01.6606.C '04-08	<b>Size</b> 99.95 99.96 99.97	<b>Ring Set</b> 02.6508 02.6508 02.6508 '04-08	<b>Bearing</b> 23.NJ206ECP-1 '04-08 2x				<b>Valve</b> 28.6520-1 '04-08 2x Exhaust Steel 28.6520-2 '04-08 2x Intake Steel
			<b>Clips</b> 05.2012 '04-08					

**ATV-UTV**  
CAN-AM  
GAS GAS  
HONDA  
KAWASAKI  
KTM  
POLARIS  
SUZUKI  
YAMAHA

**PWC**  
KAWASAKI  
POLARIS  
SEA DOO  
YAMAHA

**SNOW**  
ARCTIC CAT  
KAWASAKI  
LYNX  
MOTO-SKI  
POLARIS  
SKI DOO  
YAMAHA

**MOPED & SCOOTER**

**MISC. TECH. SPECIAL**

Footnotes: \* Bearings Only \*\* Rubbers included

<b>Air Filter</b> 52.64004 '04-08	<b>Master Cylinder Rebuild Kit</b> 16.940001 '04-08	<b>Friction Set</b> 16.S54007 '04-08	<b>F/W Bearing</b> 23.S114002 '04-08	<b>Frontbrake Disc</b> 37.BD16290 '04-08	<b>7075-T6 Alloy Rear Sprocket</b> 07.RA62090-48 07.RA62090-49 07.RA62090-50 07.RA62090-51 07.RA62090-52 '04-08	<b>Chain</b> 07.RC520120C '04-08 MX 07.RC520120CG '04-08 MX Gold 07.RC520120XC '04-08 X-Ring 07.RC520120XCG '04-08 X-Ring Gold	<b>Swingarm</b> 26.210178 '04 26.210179 '05-08	<b>Seal &amp; Wiper</b> 40.S4857.89 '04-08
<b>Main Jet</b> 45.100-225 '04-08 Keihin		<b>Steel Set</b> 16.S54009 '04-08	<b>R/W Bearing</b> 23.S112073 '04-08	<b>Front Pad Set</b> 37.102202 '04-08 37.102202BX '04-08 Box of 10		<b>Lower Chain Roller</b> 33.0003 '04-08		<b>Oil Seal Set</b> 40.F4857.89 '04-08
<b>Pilot Jet</b> 46.040-085 '04-08 Keihin			<b>F/W Spacer Kit</b> 26.710087 '04-08	<b>Rear Pad Set</b> 37.204202 '04-08 37.204202BX '04-08 Box of 10	<b>Ultralight Steel Rear Sprocket</b> 07.RS62090R-48 07.RS62090R-49 07.RS62090R-50 07.RS62090R-51 07.RS62090R-52 '04-08	<b>Upper Chain Roller</b> 33.0003 '04-08		<b>Dust Seal Set</b> 40.F4857.8D '04-08
<b>Carburetor Rebuild Kit</b> 55.10521 '04-08			<b>R/W Spacer Kit</b> 26.710084 '04-08					<b>Bushing Set</b> 39.160077 '04 39.160054 '05-08
<b>Throttle Cable</b> 53.110043 '04-08			<b>Steering Bearing</b> 24.110032 '04-08		<b>Sprocket Bolt Set</b> 07.SBSM825 '04-08			<b>Rear Shock Seal Head Kit</b> 26.810119 '04-08
<b>Oil Filter</b> 54.63655 '04-08 1-Pce. 54.63655-50 '04-08 50-Pcs.								

**DIRT**  
APRILIA  
BETA  
BMW  
GAS GAS  
HONDA  
HUSABERG  
HUSQVARNA  
KAWASAKI  
KTM  
MOTO TM  
RIEJU  
SHERCO  
SUZUKI  
YAMAHA

**STREET**  
APRILIA  
CAGIVA  
HONDA  
KAWASAKI  
KTM  
SUZUKI  
YAMAHA

**ATV-UTV**  
CAN-AM  
GAS GAS  
HONDA  
KAWASAKI  
KTM  
POLARIS  
SUZUKI  
YAMAHA

**PWC**  
KAWASAKI  
POLARIS  
SEA DOO  
YAMAHA

**SNOW**  
ARCTIC CAT  
KAWASAKI  
LYNX  
MOTO-SKI  
POLARIS  
SKI DOO  
YAMAHA

**MOPED & SCOOTER**

**MISC. TECH. SPECIAL**

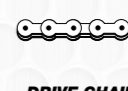

**HUSQVARNA**

DIRT	TC 50 2-Stroke Please Note: Nikasil Piston Size -KTM Engine	Piston Kit 01.6019.A 01.6019.B 01.6019.C '17-23	Size 39.46 39.47 39.48	Ring Set 02.6012 02.6012 02.6012 '17-23	CrankBearing & Seal Kit 23.CBS60013 '17-23  Bearing 23.6203T9C3 '17-23 2x  Oilseal Set 42.6013 '17-23	Con. Rod Kit 03.6011 '17-23  S/E Bearing 21.6011 '17-23  B/E Bearing 22.162212F '17-23  Crankpin 06.1635.9 '17-23	Complete 34.6012 '17-22  Top-End 35.6012 '17-23  Head & Base 36.6019 '17-23			
APRILIA BETA BMW GAS GAS HONDA HUSABERG HUSQVARNA KAWASAKI KTM MOTO TM RIEJU SHERCO SUZUKI YAMAHA	EE 3 Electronic	Piston Kit -	Size -	Ring Set -						
STREET	EE 5 Electronic	Piston Kit -	Size -	Ring Set -						
ATV-UTV	TC 65 2-Stroke Please Note: Nikasil Piston Size -KTM Engine	Piston Kit 01.6029.A 01.6029.B 01.6029.C 01.6029.D '17-23	Size 44.96 44.97 44.98 44.99	Ring Set 02.6022 02.6022 02.6022 02.6022 '17-23  Clips 05.1210C '17-23	CrankBearing & Seal Kit 23.CBS61009 '17-23  Bearing 23.6304JR2 '17-23 2x  Oilseal Set 42.6029 '17-23	Con. Rod Kit 03.6029 '17-23  S/E Bearing 21.2001 '17-23  B/E Bearing 22.182415F '17-23  Crankpin 06.1854.3 '17-23	Complete 34.6019 '17-22  Top-End 35.6019 '17-23  Head & Base 36.6019 '17-23			
PWC	TC 65 2-Stroke Please Note: Nikasil Piston Size -KTM Engine	Piston Kit 01.6029.A 01.6029.B 01.6029.C 01.6029.D '17-23	Size 44.96 44.97 44.98 44.99	Ring Set 02.6022 02.6022 02.6022 02.6022 '17-23  Clips 05.1210C '17-23	CrankBearing & Seal Kit 23.CBS61009 '17-23  Bearing 23.6304JR2 '17-23 2x  Oilseal Set 42.6029 '17-23	Con. Rod Kit 03.6029 '17-23  S/E Bearing 21.2001 '17-23  B/E Bearing 22.182415F '17-23  Crankpin 06.1854.3 '17-23	Complete 34.6019 '17-22  Top-End 35.6019 '17-23  Head & Base 36.6019 '17-23			
SNOW	ARCTIC CAT KAWASAKI LYNX MOTO-SKI POLARIS SKI DOO YAMAHA									
MOPED & SCOOTER										
MISC. TECH. SPECIAL										

Footnotes: \* Bearings Only \*\* Rubbers included

Air Filter 52.60009 '17-23	Cover Gasket 19.G6012 '17-23 Outer		F/W Bearing 23.S111035 '17-23	Frontbrake Disc 37.BD16009 '17-23	Front Sprocket 07.FS60009-10 07.FS60009-11 '17-23	Swingarm 26.210129 '17-23
Throttle Cable 53.112068 '17-20 53.112088 '21-22			R/W Bearing 23.S117011 '17-23	Rearbrake Disc 37.BD16009 '17-23		Upper 26.450070 '17-23  Lower 26.450070 '17-23
Water Pump Rebuild Kit 57.6022 '17-23			Steering Bearing 24.110047 '17-23	Front Pad Set 37.106302 '17-23 37.106302BX '17-23 Box of 10		
			F/W Bearing 23.S111035 '23	Frontbrake Disc 37.BD16009 '23		Swingarm 26.210129 '23
			Steering Bearing 24.110047 '23	Rearbrake Disc 37.BD16009 '23		
			F/W Bearing 23.S111035 '20-23	Frontbrake Disc 37.BD16009 '20-23		Swingarm 26.210129 '20-23
			R/W Bearing 23.S117011 '20-23	Rearbrake Disc 37.BD16009 '20-23		Upper 26.450070 '20-23  Lower 26.450070 '20-23
			Steering Bearing 24.110047 '20-23	Front Pad Set 37.106302 '20-23 37.106302BX '20-23 Box of 10 Rear Pad Set 37.106302 '20-23 37.106302BX '20-23 Box of 10		
Air Filter 52.61097 '17-23	Basket 17.6020F '17-23	Friction Set 16.S50012 '17-23	F/W Bearing 23.S111035 '17-23	Frontbrake Disc 37.BD16000 '17-23	Front Sprocket 07.FS60004-12 07.FS60004-13 07.FS60004-14 07.FS60004-15 '17-23	Chain 07.RC420130C '17-23 MX  Countershaft Seal Kit 26.640006 '17-23
Main Jet 47.090-580 '17-23 Mikuni	Clutch Master Cylinder Rebuild Kit 16.910055 '17-21	Steel Set 16.S50013 '17-23	R/W Bearing 23.S113045 '17-23	Rearbrake Disc 37.BD26000 '17-23		Upper 26.450070 '17-23  Lower 26.450070 '17-23
Pilot Jet 48.015-080 '17-23 Mikuni	Slave Cylinder Rebuild Kit 16.950013 '17-21		Steering Bearing 24.110047 '17-23	Front Pad Set 37.109202 '17-22 37.202302 '23 37.109202BX '17-21 Box of 10 37.202302BX '23 Box of 10	7075-T6 Alloy Rear Sprocket 07.RA60097-44 07.RA60097-45 07.RA60097-46 07.RA60097-47 07.RA60097-48 07.RA60097-49 07.RA60097-50 '17-23	
Carburetor Rebuild Kit 55.10519 '17-22				Rear Pad Set 37.109202 '17-22 37.202302 '23 37.109202BX '17-21 Box of 10 37.202302BX '23 Box of 10	Sprocket Bolt Set 07.SBSM825 '17-23	
Throttle Cable 53.110047 '17-20 53.112089 '21-23				Front Master Cylinder Rebuild Kit 16.910055 '17-23		
Water Pump Rebuild Kit 57.6029 '17-23				Brake Pedal Rebuild Kit 37.RBPK001 '17-18		

DIRT	APRILIA BETA BMW GAS GAS HONDA HUSABERG HUSQVARNA KAWASAKI KTM MOTO TM RIEJU SHERCO SUZUKI YAMAHA
STREET	APRILIA CAGIVA HONDA KAWASAKI KTM SUZUKI YAMAHA
ATV-UTV	CAN-AM GAS GAS HONDA KAWASAKI KTM POLARIS SUZUKI YAMAHA
PWC	KAWASAKI POLARIS SEA DOO YAMAHA
SNOW	ARCTIC CAT KAWASAKI LYNX MOTO-SKI POLARIS SKI DOO YAMAHA
MOPED & SCOOTER	
MISC. TECH. SPECIAL	



### HUSQVARNA

DIRT	TC 85 2-Stroke Please Note: Nikasil Piston Size -KTM Engine -Molycoated Skirt	Piston Kit 01.6105.A 01.6105.B 01.6105.C 01.6105.D '14-23	Size 46.95 46.96 46.97 46.98	Ring Set 02.6105 02.6105 02.6105 02.6105 '14-23	CrankBearing & Seal Kit 23.CBS61003 '14-23	Con. Rod Kit 03.6113 '14-23	Complete 34.6113 '14-17			
APRILIA BETA BMW GAS GAS HONDA HUSABERG HUSQVARNA KAWASAKI KTM MOTO TM RIEJU SHERCO SUZUKI YAMAHA				<b>Clips</b> 05.1410C '14-23	<b>Bearing</b> 23.NJ205 '14-23 Left 23.6304/22 '14-23 Right	<b>S/E Bearing</b> 21.1111 '14-23	<b>Top-End</b> 35.6113 '14-17 35.6118 '18-23	<b>Head &amp; Base</b> 36.6113 '14-17 36.6118 '18-23		
<b>STREET</b>	APRILIA CAGIVA HONDA KAWASAKI KTM SUZUKI YAMAHA				<b>Oilseal Set</b> 42.6103 '14-23	<b>B/E Bearing</b> 22.202615F '14-23				
<b>ATV-UTV</b>	CAN-AM GAS GAS HONDA KAWASAKI KTM POLARIS SUZUKI YAMAHA	CR / WR 125 2-Stroke Please Note: Nikasil Piston Size -Molycoated Skirt	Piston Kit 01.6216.A 01.6216.B 01.6216.C 01.6216.D '97-13	Size 53.94 53.95 53.96 53.97	Ring Set 02.6220 02.6220 02.6220 02.6220 '97-13	CrankBearing & Seal Kit 23.CBS62020 '98-13	Con. Rod Kit 03.6217 '97-13			
<b>PWC</b>	KAWASAKI POLARIS SEA DOO YAMAHA			<b>Clips</b> 05.1510 '97-13	<b>Bearing</b> 23.6322C4 '97-13 2x	<b>S/E Bearing</b> 21.1211 '97-13				
<b>SNOW</b>	ARCTIC CAT KAWASAKI LYNX MOTO-SKI POLARIS SKI DOO YAMAHA				<b>Oilseal Set</b> 42.6202 '98-13					
<b>MOPED &amp; SCOOTER</b>										
<b>MISC. TECH. SPECIAL</b>										

Footnotes: \* Bearings Only \*\* Rubbers included

Air Filter 52.62011 '14-17 52.61018 '18-23	Basket 17.6103F '14-17	Complete Plate Set 16.CPS61003 '14-17 16.CPS61018 '18-23	F/W Bearing 23.S114006 '14-23	Frontbrake Disc 37.BD16112 '14-23	Front Sprocket 07.FS61004-12 07.FS61004-13 07.FS61004-14 07.FS61004-15 '14-17	Chain 07.RC428130C '14-23 MX	Swingarm 26.210087 '14-23	Seal & Wiper 40.S4352.99P '14-17
<b>Main Jet</b> 45.100-225 '14-23 Keihin	<b>Spring Kit</b> 17.CS61043 '14-17	<b>Friction Set</b> 16.S51011 '14-17 16.S51018 '18-23	<b>R/W Bearing</b> 23.S112073 '14-23	<b>Rearbrake Disc</b> 37.BD26111 '14-20 37.BD26190 '21-23	<b>Countershaft Seal Kit</b> 26.640005 '14-23	<b>Lower</b> 26.350059 '14-23	<b>Oil Seal Set</b> 40.F4352.99P '14-17	<b>Dust Seal Set</b> 40.F4353.4DP '14-17
<b>Pilot Jet</b> 46.040-085 '14-23 Keihin	<b>Cover Gasket</b> 19.G6103 '14-17	<b>Steel Set</b> 16.S51012 '14-17 16.S51019 '18-23	<b>F/W Spacer Kit</b> 26.710105 '14-23	<b>Front Pad Set</b> 37.160202 '14-20 37.160202BX '14-20 Box of 10 37.102202 '21-23 37.102202BX '21-23 Box of 10	<b>Upper</b> 26.350059 '14-23	<b>Dust Seal Set</b> 40.F4353.4DP '14-17	<b>Bushing Set</b> 39.160121 '14-17	<b>Rear Shock Seal Head Kit</b> 26.810120 '14-20
<b>Carburetor Rebuild Kit</b> 55.10518 '14-22	<b>Clutch Master Cylinder Rebuild Kit</b> 16.910055 '14-23	<b>Slave Cylinder Rebuild Kit</b> 16.950013 '14-23	<b>R/W Spacer Kit</b> 26.710084 '14-23	<b>Rear Pad Set</b> 37.289102 '14-20 37.289102BX '14-20 Box of 10 37.202302 '21-23 37.202302BX '21-23 Box of 10	<b>7075-T6 Alloy Rear Sprocket</b> 07.RA61003-46 07.RA61003-47 07.RA61003-48 07.RA61003-49 07.RA61003-50 07.RA61003-51 '14-23	<b>Ultralight Steel Rear Sprocket</b> 07.RS61003R-46 07.RS61003R-47 07.RS61003R-48 07.RS61003R-49 07.RS61003R-50 07.RS61003R-51 '14-23	<b>Sprocket Bolt Set</b> 07.SBSM825 '14-23	
<b>Throttle Cable</b> 53.110046 '14-17 53.112069 '18-21	<b>Water Pump Rebuild Kit</b> 57.6123 '14-17		<b>Steering Bearing</b> 24.110047 '14-23	<b>Brake Pedal Rebuild Kit</b> 37.RBPK001 '14-17				
<b>Air Filter</b> 52.63092 '92-13	<b>Spring Kit</b> 17.CS62048 '00-13	<b>Complete Plate Set</b> 16.CPS62000 '00-13	<b>F/W Bearing</b> 23.S114017 '96-99 23.S114026 '00 CR 23.S114015 '01-13 CR 23.S114013 '00 WR 23.S114027 '01 WR 23.S114015 '02-13 WR	<b>Frontbrake Disc</b> 37.BD16200 '00-13	<b>Front Sprocket</b> 07.FS62098-13 07.FS62098-14 '98-13	<b>Chain</b> 07.RC520120C '90-13 MX 07.RC520120CG '90-13 MX Gold 07.RC520120XC '90-13 X-Ring 07.RC520120XCG '90-13 X-Ring Gold	<b>Swingarm</b> 26.210119 '96-08 26.210199 '09-13	<b>Seal &amp; Wiper</b> 40.S485810 '10-13
<b>Main Jet</b> 47.090-580 '05-13 Mikuni	<b>Clutch Cable</b> 53.121021 '00-07 + '09-12	<b>Friction Set</b> 16.S12004 '00-13	<b>Rearbrake Disc</b> 37.BD26211 '11-13	<b>Rearbrake Disc</b> 37.102202 '95-13 37.102202BX '95-13 Box of 10	<b>7075-T6 Alloy Rear Sprocket</b> 07.RA62097-46 07.RA62097-47 07.RA62097-48 07.RA62097-49 07.RA62097-50 07.RA62097-51 07.RA62097-52 '90-13	<b>Linkage</b> 26.110119 '96-01 CR 26.110162 '96-00 WR 26.110119 '01 WR 26.110133 '02-04 26.110146 '06-08 26.110176 '09-13	<b>Oil Seal Set</b> 40.F485810 '10-13	<b>Dust Seal Set</b> 40.F4858D '10-13
<b>Pilot Jet</b> 49.010-045 '05-13 Mikuni		<b>Steel Set</b> 16.S62000 '00-13	<b>Front Pad Set</b> 37.102202 '95-13 37.102202BX '95-13 Box of 10	<b>Front Pad Set</b> 37.204202 '95-04 CR 37.204202BX '95-04 CR Box of 10 37.202302 '05-13 CR 37.202302BX '05-13 CR Box of 10 37.204202 '95-05 WR 37.204202BX '95-05 WR Box of 10	<b>Ultralight Steel Rear Sprocket</b> 07.RS62097R-46 07.RS62097R-47 07.RS62097R-48 07.RS62097R-49 07.RS62097R-50 07.RS62097R-51 07.RS62097R-52 '90-13	<b>Lower Chain Roller</b> 33.0001 '96-13	<b>Bushing Set</b> 39.160068 '10-13	<b>Rear Shock Seal Head Kit</b> 26.810124 '01-04
<b>Carburetor Rebuild Kit</b> 55.10584 '93-08 CR '96-08 WR 55.10583 '09-13			<b>R/W Bearing</b> 23.S114019 '96-98 23.S114018 '99 23.S114020 '00-13	<b>Rear Pad Set</b> 37.204202 '95-04 CR 37.204202BX '95-04 CR Box of 10 37.202302 '05-13 CR 37.202302BX '05-13 CR Box of 10 37.204202 '95-05 WR 37.204202BX '95-05 WR Box of 10	<b>Upper Chain Roller</b> 33.0001 '96-13	<b>Upper</b> 26.350080 '98-13	<b>Lower</b> 26.450044 '96-08 26.450062 '09	
<b>Throttle Cable</b> 53.110055 '00-13 CR '00-08 + 12 WR			<b>Steering Bearing</b> 24.110032 '98 CR 24.110061 '99-13 CR 24.110032 '98-07 WR 24.110061 '08-13 WR	<b>Sprocket Bolt Set</b> 07.SBSM825 '90-13				

DIRT	APRILIA BETA BMW GAS GAS HONDA HUSABERG HUSQVARNA KAWASAKI KTM MOTO TM RIEJU SHERCO SUZUKI YAMAHA
<b>STREET</b>	APRILIA CAGIVA HONDA KAWASAKI KTM SUZUKI YAMAHA
<b>ATV-UTV</b>	CAN-AM GAS GAS HONDA KAWASAKI KTM POLARIS SUZUKI YAMAHA
<b>PWC</b>	KAWASAKI POLARIS SEA DOO YAMAHA
<b>SNOW</b>	ARCTIC CAT KAWASAKI LYNX MOTO-SKI POLARIS SKI DOO YAMAHA
<b>MOPED &amp; SCOOTER</b>	
<b>MISC. TECH. SPECIAL</b>	



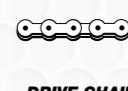

### HUSQVARNA

**DIRT**  
APRILIA  
BETA  
BMW  
GAS GAS  
HONDA  
HUSABERG  
HUSQVARNA  
KAWASAKI  
KTM  
MOTO TM  
RIEJU  
SHERCO  
SUZUKI  
YAMAHA

TC 125  
2-Stroke  
Please Note:  
Nikasil Piston Size  
-KTM Engine  
-Molycoated Skirt  
-Fuel Injection from 2023

**Piston Kit**  
01.6226.A  
01.6226.B  
01.6226.C  
01.6226.D  
01.6226.E  
'14-23

**Size**  
53.94  
53.95  
53.96  
53.97  
53.98

**Ring Set**  
02.6225  
02.6225  
02.6225  
02.6225  
02.6225  
'14-23

**Crank Bearing & Seal Kit**  
23.CBS62001  
'14-23  
  
**Bearing**  
23.NJ206  
'14-23 Left  
23.6305JR2  
'14-23 Right  
  
**Pin**  
23.6305JR2  
'14-23 Right  
  
**Oilseal Set**  
42.6218  
'14-23

**Con. Rod Kit**  
03.6220  
'14-15  
03.6226  
'16-23  
  
**S/E Bearing**  
21.3206  
'14-23  
  
**B/E Bearing**  
22.222816F  
'14-23  
  
**Crankpin**  
06.2255  
'14-15  
06.2255.9  
'16-23

**Complete**  
34.6227  
'14-15  
34.6216  
'16-17  
  
**Top-End**  
35.6227  
'14-15  
35.6216  
'16-22  
  
**Head & Base**  
36.6216  
'16-23  
  
**Ignition Cover Gasket**  
19.G96221  
'14-15

**STREET**  
APRILIA  
CAGIVA  
HONDA  
KAWASAKI  
KTM  
SUZUKI  
YAMAHA

**ATV-UTV**  
CAN-AM  
GAS GAS  
HONDA  
KAWASAKI  
KTM  
POLARIS  
SUZUKI  
YAMAHA

**PWC**  
KAWASAKI  
POLARIS  
SEA DOO  
YAMAHA

**SNOW**  
ARCTIC CAT  
KAWASAKI  
LYNX  
MOTO-SKI  
POLARIS  
SKI DOO  
YAMAHA

**MOPED & SCOOTER**

**MISC. TECH. SPECIAL**

**Air Filter**  
52.62011  
'14-15  
52.62016  
'16-22  
52.62023  
'23  
  
**Main Jet**  
45.100-225  
'14-16 Keihin  
47.090-580  
'17-22 Mikuni  
  
**Pilot Jet**  
46.040-085  
'14-16 Keihin  
49.010-045  
'17-22 Mikuni  
  
**Carburetor Rebuild Kit**  
55.10514  
'14-16

**Basket**  
17.6218F \*  
'14-18  
  
**Clutch Rubber Set**  
17.CRS1287-8  
'14-18  
  
**Inner Hub**  
18.1290  
'14-18  
  
**Spring Kit**  
17.CS12003  
'14-15  
17.CS62048  
'16  
  
**Cover Gasket**  
19.G6218  
'14-15  
19.G6216  
'16-22

**Complete Plate Set**  
16.CPS62098  
'14-15  
16.CPS62008  
'16  
16.CPS63029  
'19-23  
  
**Friction Set**  
16.S52001  
'14-18  
16.S53009  
'19-23  
  
**Steel/Alloy**  
16.S52002  
'14-18  
16.S53010  
'19-23

**F/W Bearing**  
23.S114002  
'14-23  
  
**R/W Bearing**  
23.S112073  
'14-22  
23.S160023  
'23  
  
**F/W Spacer Kit**  
26.710087  
'14  
26.710103  
'15-23  
  
**R/W Spacer Kit**  
26.710084  
'14-15  
26.710102  
'16-22  
  
**Steering Bearing**  
24.110026  
'14-22

**Frontbrake Disc**  
37.BD16290  
'14-23  
  
**Rearbrake Disc**  
37.BD26190  
'14-23  
  
**Front Pad Set**  
37.102202  
'14-23  
37.102202BX  
'14-23 Box of 10  
  
**Rear Pad Set**  
37.202302  
'14-23  
37.202302BX  
'14-23 Box of 10  
  
**Front Caliper Rebuild Kit**  
37.63046  
'14-23  
  
**Rear Caliper Rebuild Kit**  
37.63048  
'14-23  
  
**Front Master Cylinder Rebuild Kit**  
37.910035  
'14-23  
  
**Rear Master Cylinder Rebuild Kit**  
37.910030  
'14-23  
  
**Brake Pedal Rebuild Kit**  
37.RBPK001  
'14-15  
37.RBPK003  
'16-17

**Front Sprocket**  
07.FS62093-12  
07.FS62093-13  
07.FS62093-14  
07.FS62093-15  
'14-23  
  
**7075-T6 Alloy Rear Sprocket**  
07.RA62090-48  
07.RA62090-49  
07.RA62090-50  
07.RA62090-51  
07.RA62090-52  
'14-23  
  
**UltraLight Steel Rear Sprocket**  
07.RS62090R-48  
07.RS62090R-49  
07.RS62090R-50  
07.RS62090R-51  
07.RS62090R-52  
'14-23  
  
**Sprocket Bolt Set**  
07.SBSM825  
'14-23

**Chain**  
07.RC520120C  
'14-23 MX  
07.RC520120CG  
'14-23 MX Gold  
07.RC520120XC  
'14-23 X-Ring  
07.RC520120XCG  
'14-23 X-Ring Gold  
  
**Countershaft Seal Kit**  
26.640001  
'14-15  
26.640045  
'16-22

**Swingarm**  
26.210168  
'14-15  
26.210125  
'16-23  
  
**Linkage**  
26.110180  
'14-20  
  
**Lower**  
26.450066  
'14-20  
  
**Upper**  
26.450068  
'14-23

**Seal & Wiper**  
40.S4857.89  
'14  
  
**Oil Seal Set**  
40.F4857.89  
'14  
  
**Dust Seal Set**  
40.F4857.8D  
'14  
  
**Bushing Set**  
39.160082  
'14  
39.160122  
'15-17  
  
**Rear Shock Seal Head Kit**  
26.810127  
'14-20

**DIRT**  
APRILIA  
BETA  
BMW  
GAS GAS  
HONDA  
HUSABERG  
HUSQVARNA  
KAWASAKI  
KTM  
MOTO TM  
RIEJU  
SHERCO  
SUZUKI  
YAMAHA

**STREET**  
APRILIA  
CAGIVA  
HONDA  
KAWASAKI  
KTM  
SUZUKI  
YAMAHA

**ATV-UTV**  
CAN-AM  
GAS GAS  
HONDA  
KAWASAKI  
KTM  
POLARIS  
SUZUKI  
YAMAHA

**PWC**  
KAWASAKI  
POLARIS  
SEA DOO  
YAMAHA

**SNOW**  
ARCTIC CAT  
KAWASAKI  
LYNX  
MOTO-SKI  
POLARIS  
SKI DOO  
YAMAHA

**MOPED & SCOOTER**

**MISC. TECH. SPECIAL**

Footnotes: \* Bearings Only \*\* Rubbers included



**HUSQVARNA**

**DIRT**  
 APRILIA  
 BETA  
 BMW  
 GAS GAS  
 HONDA  
 HUSABERG  
 HUSQVARNA  
 KAWASAKI  
 KTM  
 MOTO TM  
 RIEJU  
 SHERCO  
 SUZUKI  
 YAMAHA

TE 125 2-Stroke Please Note: Nikasil Piston Size -KTM Engine -Molycoated Skirt	<b>Piston Kit</b> 01.6226.A 01.6226.B 01.6226.C 01.6226.D 01.6226.E '14-16	<b>Size</b> 53.94 53.95 53.96 53.97 53.98	<b>Ring Set</b> 02.6225 02.6225 02.6225 02.6225 02.6225 '14-16	<b>CrankBearing &amp; Seal Kit</b> 23.CBS62001 '14-16	<b>Con. Rod Kit</b> 03.6220 '14-16	<b>Complete</b> 34.6227 '14-16					
			<b>Pin</b> 04.1545 '14-16	<b>Bearing</b> 23.NJ206 '14-16 Left 23.6305JR2 '14-16 Right	<b>S/E Bearing</b> 21.3206 '14-16	<b>Top-End</b> 35.6227 '14-16					
			<b>Clips</b> 05.1510 '14-16	<b>Oilseal Set</b> 42.6218 '14-16	<b>B/E Bearing</b> 22.222816F '14-16	<b>Ignition Cover Gasket</b> 19.G96221 '14-16					
					<b>Crankpin</b> 06.2255 '14-16						

**STREET**  
 APRILIA  
 CAGIVA  
 HONDA  
 KAWASAKI  
 KTM  
 SUZUKI  
 YAMAHA

TX 125 2-Stroke Please Note: Nikasil Piston Size -KTM Engine -Molycoated Skirt	<b>Piston Kit</b> 01.6226.A 01.6226.B 01.6226.C 01.6226.D 01.6226.E '17-19	<b>Size</b> 53.94 53.95 53.96 53.97 53.98	<b>Ring Set</b> 02.6225 02.6225 02.6225 02.6225 02.6225 '17-19	<b>CrankBearing &amp; Seal Kit</b> 23.CBS62001 '17-19	<b>Con. Rod Kit</b> 03.6226 '17-19	<b>Top-End</b> 35.6216 '17-19					
			<b>Pin</b> 04.1545 '17-19	<b>Bearing</b> 23.NJ206 '17-19 Left 23.6305JR2 '17-19 Right	<b>S/E Bearing</b> 21.3206 '17-19	<b>Head &amp; Base</b> 36.6216 '17-19					
			<b>Clips</b> 05.1510 '17-19	<b>Oilseal Set</b> 42.6218 '17-19	<b>B/E Bearing</b> 22.222816F '17-19						
					<b>Crankpin</b> 06.2255.9 '17-19						

**SNOW**  
 ARCTIC CAT  
 KAWASAKI  
 LYNX  
 MOTO-SKI  
 POLARIS  
 SKI DOO  
 YAMAHA

--	--	--	--	--	--	--	--	--	--	--	--

**MOPED & SCOOTER**

--	--	--	--	--	--	--	--	--	--	--	--

**MISC. TECH. SPECIAL**

--	--	--	--	--	--	--	--	--	--	--	--

Footnotes: \* Bearings Only \*\* Rubbers included

**DIRT**  
 APRILIA  
 BETA  
 BMW  
 GAS GAS  
 HONDA  
 HUSABERG  
 HUSQVARNA  
 KAWASAKI  
 KTM  
 MOTO TM  
 RIEJU  
 SHERCO  
 SUZUKI  
 YAMAHA

<b>Air Filter</b> 52.62011 '14-16	<b>Basket</b> 17.6218F * '14-16	<b>Complete Plate Set</b> 16.CPS62098 '14-16	<b>F/W Bearing</b> 23.S114002 '14-16	<b>Frontbrake Disc</b> 37.BD16290 '14-16	<b>Front Sprocket</b> 07.FS62093-12 07.FS62093-13 07.FS62093-14 07.FS62093-15 '14-16	<b>Chain</b> 07.RC520120C '14-16 MX 07.RC520120CG '14-16 MX Gold 07.RC520120XC '14-16 X-Ring 07.RC520120XCG '14-16 X-Ring Gold	<b>Swingarm</b> 26.210168 '14-16	<b>Seal &amp; Wiper</b> 40.S4857.89 '14
<b>Main Jet</b> 45.100-225 '14-16 Keihin	<b>Clutch Rubber Set</b> 17.CRS1287-8 '14-16	<b>Friction Set</b> 16.S52001 '14-16	<b>R/W Bearing</b> 23.S112073 '14-16	<b>Rearbrake Disc</b> 37.BD26190 '14-16			<b>Linkage</b> 26.110180 '14-16	<b>Oil Seal Set</b> 40.F4857.89 '14
<b>Pilot Jet</b> 46.040-085 '14-16 Keihin	<b>Inner Hub</b> 18.1290 '14-16	<b>Steel/Alloy</b> 16.S52002 '14-16	<b>F/W Spacer Kit</b> 26.710087 '14-15 26.710103 '16	<b>Front Pad Set</b> 37.102202 '14-16 37.102202BX '14-16 Box of 10	<b>7075-T6 Alloy Rear Sprocket</b> 07.RA62090-48 07.RA62090-49 07.RA62090-50 07.RA62090-51 07.RA62090-52 '14-16	<b>Countershaft Seal Kit</b> 26.640001 '14-16	<b>Lower</b> 26.450066 '14-16	<b>Dust Seal Set</b> 40.F4857.8D '14
<b>Carburetor Rebuild Kit</b> 55.10514 '15-16	<b>Spring Kit</b> 17.CS12003 '14-16		<b>R/W Spacer Kit</b> 26.710084 '14-16	<b>Rear Pad Set</b> 37.202302 '14-16 37.202302BX '14-16 Box of 10	<b>Ultralight Steel Rear Sprocket</b> 07.RS62090R-48 07.RS62090R-49 07.RS62090R-50 07.RS62090R-51 07.RS62090R-52 '14-16		<b>Upper</b> 26.450068 '14-16	<b>Bushing Set</b> 39.160082 '14 39.160122 '15-16
<b>Throttle Cable</b> 53.110046 '14-16	<b>Cover Gasket</b> 19.G6218 '14-16		<b>Steering Bearing</b> 24.110026 '14-16	<b>Front Caliper Rebuild Kit</b> 37.63046 '14-16				<b>Rear Shock Seal Head Kit</b> 26.810127 '14-16
<b>Water Pump Rebuild Kit</b> 57.6218 '14-16	<b>Master Cylinder Rebuild Kit</b> 16.940003 '15-16			<b>Rear Caliper Rebuild Kit</b> 37.63048 '14-16	<b>Sprocket Bolt Set</b> 07.SBSM825 '14-16			
	<b>Slave Cylinder Rebuild Kit</b> 16.950006 '15-16			<b>Front Master Cylinder Rebuild Kit</b> 37.910035 '14-16				
				<b>Rear Master Cylinder Rebuild Kit</b> 37.910030 '14-16				
				<b>Brake Pedal Rebuild Kit</b> 37.RBPK001 '14-16				

**STREET**  
 APRILIA  
 CAGIVA  
 HONDA  
 KAWASAKI  
 KTM  
 SUZUKI  
 YAMAHA

<b>Air Filter</b> 52.62016 '17-19	<b>Basket</b> 17.6218F * '17-18	<b>Complete Plate Set</b> 16.CPS63029 '19	<b>F/W Bearing</b> 23.S114002 '17-19	<b>Frontbrake Disc</b> 37.BD16290 '17-19	<b>Front Sprocket</b> 07.FS62093-12 07.FS62093-13 07.FS62093-14 07.FS62093-15 '17-19	<b>Chain</b> 07.RC520120C '17-19 MX 07.RC520120CG '17-19 MX Gold 07.RC520120XC '17-19 X-Ring 07.RC520120XCG '17-19 X-Ring Gold	<b>Swingarm</b> 26.210125 '17-19	<b>Rear Shock Seal Head Kit</b> 26.810127 '17-19
<b>Main Jet</b> 47.090-580 '17-19 Mikuni	<b>Clutch Rubber Set</b> 17.CRS1287-8 '17-18	<b>Friction Set</b> 16.S52001 '17-18 16.S53009 '19	<b>R/W Bearing</b> 23.S112073 '17-19	<b>Rearbrake Disc</b> 37.BD26190 '17-19			<b>Linkage</b> 26.110180 '17-19	
<b>Pilot Jet</b> 49.010-045 '17-19 Mikuni	<b>Inner Hub</b> 18.1290 '17-18	<b>Steel/Alloy</b> 16.S52002 '17-18 16.S53010 '19	<b>F/W Spacer Kit</b> 26.710103 '17-19	<b>Front Pad Set</b> 37.102202 '17-19 37.102202BX '17-19 Box of 10	<b>7075-T6 Alloy Rear Sprocket</b> 07.RA62090-48 07.RA62090-49 07.RA62090-50 07.RA62090-51 07.RA62090-52 '17-19	<b>Countershaft Seal Kit</b> 26.640045 '17-19	<b>Upper</b> 26.450068 '17-19	
<b>Throttle Cable</b> 53.112059 '17-19	<b>Cover Gasket</b> 19.G6216 '17-19		<b>R/W Spacer Kit</b> 26.710084 '17-19	<b>Rear Pad Set</b> 37.202302 '17-19 37.202302BX '17-19 Box of 10	<b>Ultralight Steel Rear Sprocket</b> 07.RS62090R-48 07.RS62090R-49 07.RS62090R-50 07.RS62090R-51 07.RS62090R-52 '17-19		<b>Lower</b> 26.450066 '17-19	
			<b>Steering Bearing</b> 24.110026 '17-19	<b>Front Caliper Rebuild Kit</b> 37.63046 '17				
				<b>Front Master Cylinder Rebuild Kit</b> 37.910035 '17	<b>Sprocket Bolt Set</b> 07.SBSM825 '17-19			
				<b>Rear Master Cylinder Rebuild Kit</b> 37.910030 '17				

**PWC**  
 KAWASAKI  
 POLARIS  
 SEA DOO  
 YAMAHA

--	--	--	--	--	--	--	--	--

**SNOW**  
 ARCTIC CAT  
 KAWASAKI  
 LYNX  
 MOTO-SKI  
 POLARIS  
 SKI DOO  
 YAMAHA

--	--	--	--	--	--	--	--	--

**MOPED & SCOOTER**

--	--	--	--	--	--	--	--	--

**MISC. TECH. SPECIAL**





### HUSQVARNA

**DIRT**  
APRILIA  
BETA  
BMW  
GAS GAS  
HONDA  
HUSABERG  
HUSQVARNA  
KAWASAKI  
KTM  
MOTO TM  
RIEJU  
SHERCO  
SUZUKI  
YAMAHA

**STREET**  
APRILIA  
CAGIVA  
HONDA  
KAWASAKI  
KTM  
SUZUKI  
YAMAHA

**ATV-UTV**  
CAN-AM  
GAS GAS  
HONDA  
KAWASAKI  
KTM  
POLARIS  
SUZUKI  
YAMAHA

**PWC**  
KAWASAKI  
POLARIS  
SEA DOO  
YAMAHA

**SNOW**  
ARCTIC CAT  
KAWASAKI  
LYNX  
MOTO-SKI  
POLARIS  
SKI DOO  
YAMAHA

**MOPED & SCOOTER**

**MISC. TECH. SPECIAL**

CR 150 2-Stroke	Piston Kit -	Size 58.00	Ring Set -	Bearing 23.6322C4 '11 2x	Con. Rod Kit 03.6217 '11  S/E Bearing 21.1211 '11				
TE 150 / TE 150 i 2-Stroke Please Note: Nikasil Piston Size -KTM Engine -Forged Piston -Fuel Injection from 2020	Piston Kit 01.6237.A 01.6237.B 01.6237.C '17-20	Size 57.94 57.95 57.96	Ring Set 02.6237 02.6237 02.6237 '17-20	Crankbearing & Seal Kit 23.CBS62001 '17-23  Bearing 23.NJ206 '17-23 Left 23.6305JR2 '17-23 Right  Oilseal Set 42.6218 '17-23	Con. Rod Kit 03.6226 '17-23  S/E Bearing 21.3206 '17-23  B/E Bearing 22.222816F '17-23  Crankpin 06.2255.9 '17-23	Complete 34.6216 '17  Top-End 35.6216 '17-23  Head & Base 36.6236 '17-23  Ignition Cover Gasket 19.G96217 '17-23			
	01.6241.A 01.6241.B 01.6241.C '21-23	57.94 57.95 57.96	02.6236 02.6236 02.6236 '21-23						
			Pin 04.1546.9 '21-23  Clips 05.1510 '17-23						

Footnotes: \* Bearings Only \*\* Rubbers included

**DIRT**  
APRILIA  
BETA  
BMW  
GAS GAS  
HONDA  
HUSABERG  
HUSQVARNA  
KAWASAKI  
KTM  
MOTO TM  
RIEJU  
SHERCO  
SUZUKI  
YAMAHA

**STREET**  
APRILIA  
CAGIVA  
HONDA  
KAWASAKI  
KTM  
SUZUKI  
YAMAHA

**ATV-UTV**  
CAN-AM  
GAS GAS  
HONDA  
KAWASAKI  
KTM  
POLARIS  
SUZUKI  
YAMAHA

**PWC**  
KAWASAKI  
POLARIS  
SEA DOO  
YAMAHA

**SNOW**  
ARCTIC CAT  
KAWASAKI  
LYNX  
MOTO-SKI  
POLARIS  
SKI DOO  
YAMAHA

**MOPED & SCOOTER**

**MISC. TECH. SPECIAL**

Main Jet 47.090-580 '11 Mikuni  Pilot Jet 49.010-045 '11 Mikuni		Friction Set 16.S12004 '11  Steel Set 16.S62000 '11	F/W Bearing 23.S114015 '11  R/W Bearing 23.S114020 '11  Steering Bearing 24.110061 '11	Front Pad Set 37.102202 '11 37.102202BX '11 Box of 10  Rear Pad Set 37.202302 '11 37.202302BX '11 Box of 10	Front Sprocket 07.FS62098-13 07.FS62098-14 '11  7075-T6 Alloy Rear Sprocket 07.RA62097-46 07.RA62097-47 07.RA62097-48 07.RA62097-49 07.RA62097-50 07.RA62097-51 07.RA62097-52 '11  Ultralight Steel Rear Sprocket 07.RS62097R-46 07.RS62097R-47 07.RS62097R-48 07.RS62097R-49 07.RS62097R-50 07.RS62097R-51 07.RS62097R-52 '11  Sprocket Bolt Set 07.SBSM825 '11	Chain 07.RC520120C '11 MX 07.RC520120CG '11 MX Gold 07.RC520120XC '11 X-Ring 07.RC520120XCG '11 X-Ring Gold	Swingarm 26.210199 '11  Linkage 26.110176 '11	Seal & Wiper 40.S485810 '11  Oil Seal Set 40.F485810 '11  Dust Seal Set 40.F4858D '11
Air Filter 52.62016 '17-23  Main Jet 47.090-580 '17-19 Mikuni  Pilot Jet 49.010-045 '17-19 Mikuni  Throttle Cable 53.112059 '17-19 53.112072 '20-22 53.112091 '23  Water Pump Rebuild Kit 57.6216 '17	Basket 17.6218F * '17-18  Clutch Rubber Set 17.CRS1287-8 '17-18  Inner Hub 18.1290 '17-18  Cover Gasket 19.G6216 '17-23  Master Cylinder Rebuild Kit 16.940011 '17-21  Slave Cylinder Rebuild Kit 16.950015 '17 16.950014 '18-19 16.950015 '20-21	Complete Plate Set 16.CPS63029 '19-23  Friction Set 16.S52001 '17-18 16.S53009 '19-23  Steel/Alloy 16.S52002 '17-18 16.S53010 '19-23	F/W Bearing 23.S114002 '17-23  R/W Bearing 23.S112073 '17-23  F/W Spacer Kit 26.710103 '17-23  R/W Spacer Kit 26.710084 '17-23  Steering Bearing 24.110026 '17-23	Frontbrake Disc 37.BD16290 '17-23  Rearbrake Disc 37.BD26190 '17-23  Front Pad Set 37.102202 '17-23 37.102202BX '17-23 Box of 10  Rear Pad Set 37.202302 '17-23 37.202302BX '17-23 Box of 10  Front Caliper Rebuild Kit 37.63046 '17  Front Master Cylinder Rebuild Kit 37.910035 '17  Rear Master Cylinder Rebuild Kit 37.910030 '17  Brake Pedal Rebuild Kit 37.RBPK003 '17	Front Sprocket 07.FS62093-12 07.FS62093-13 07.FS62093-14 07.FS62093-15 '17-23  7075-T6 Alloy Rear Sprocket 07.RA62090-48 07.RA62090-49 07.RA62090-50 07.RA62090-51 07.RA62090-52 '17-23  Ultralight Steel Rear Sprocket 07.RS62090R-48 07.RS62090R-49 07.RS62090R-50 07.RS62090R-51 07.RS62090R-52 '17-23  Sprocket Bolt Set 07.SBSM825 '17-23	Chain 07.RC520120C '17-23 MX 07.RC520120CG '17-23 MX Gold 07.RC520120XC '17-23 X-Ring 07.RC520120XCG '17-23 X-Ring Gold	Swingarm 26.210125 '17-23  Linkage 26.110180 '17-23  Lower 26.450066 '17-23  Upper 26.450068 '17-23	Bushing Set 39.160122 '17  Rear Shock Seal Head Kit 26.810127 '17-20



### HUSQVARNA

**DIRT**  
APRILIA  
BETA  
BMW  
GAS GAS  
HONDA  
HUSABERG  
HUSQVARNA  
KAWASAKI  
KTM  
MOTO TM  
RIEJU  
SHERCO  
SUZUKI  
YAMAHA

CR / WR 250 2-Stroke Please Note: Nikasil Piston Size -Molycoated Skirt	<b>Piston Kit</b> 01.1320.A 01.1320.A1 01.1320.A2 01.1320.A3 '98-13	<b>SIZES (mm)</b> 66.34 66.35 66.36 66.37	<b>Ring Set</b> 02.1315 02.1315 02.1315 02.1315 '98-13	<b>Pin</b> 04.1856 '98-13	<b>Clips</b> 05.1812 '98-13	<b>Con. Rod Kit</b> 03.6319 '99-13	<b>S/E Bearing</b> 21.1303 '99-13	<b>B/E Bearing</b> 22.243017F '99-13
---	--	---	---	---------------------------------	-----------------------------------	--	---	--

**STREET**  
APRILIA  
CAGIVA  
HONDA  
KAWASAKI  
KTM  
SUZUKI  
YAMAHA

TC 250 2-Stroke Please Note: Nikasil Piston Size -KTM Engine -Molycoated Skirt - Fuel Injection from 2023	<b>Piston Kit</b> 01.6343.A 01.6343.B 01.6343.C 01.6343.D '14-23	<b>Size</b> 66.34 66.35 66.36 66.37	<b>Ring Set</b> 02.6324 02.6324 02.6324 02.6324 '14-23	<b>Pin</b> 04.1856 '14-23	<b>Clips</b> 05.1812 '14-23	<b>Crank Bearing &amp; Seal Kit</b> 23.CBS63004 '14-23	<b>Bearing</b> 23.NJ207ECS '14-23 Left 23.6232X2 '14-23 Right	<b>Oilseal Set</b> 42.6320 '14-23	<b>Con. Rod Kit</b> 03.6323 '14-23	<b>S/E Bearing</b> 21.6320 '14-23	<b>B/E Bearing</b> 22.243017F '14-23	<b>Crankpin</b> 06.2459.6 '14-23	<b>Complete</b> 34.6327 '14-16 34.6317 '17-22	<b>Top-End</b> 35.6327 '14-16 35.6317 '17-19 35.6320 '20-22	<b>Head &amp; Base</b> 36.6307 '14-16 36.6317 '17-22	<b>Ignition Cover Gasket</b> 19.G96303 '14-16
---	---	---	---	---------------------------------	-----------------------------------	--	---	---	--	---	--	--	---	---	--	---

**PWC**  
KAWASAKI  
POLARIS  
SEA DOO  
YAMAHA

Footnotes: * Bearings Only ** Rubbers included
--

<b>Air Filter</b> 52.63092 '92-13	<b>Clutch Cable</b> 53.121020 '00-12	<b>Friction Set</b> 16.S13010 '00-13	<b>F/W Bearing</b> 23.S114017 '96-99 23.S114026 '00 CR 23.S114015 '01-05 CR 23.S114013 '00 WR 23.S114027 '01 WR 23.S114014 '02 WR 23.S114015 '03-13 WR	<b>Frontbrake Disc</b> 37.BD16200 '00-13	<b>Front Sprocket</b> 07.FS63000-12 07.FS63000-13 07.FS63000-14 07.FS63000-15 '00-13	<b>Chain</b> 07.RC520120C '90-13 MX 07.RC520120CG '90-13 MX Gold 07.RC520120XC '90-13 X-Ring 07.RC520120XCG '90-13 X-Ring Gold	<b>Swingarm</b> 26.210119 '96-04 CR '96-13 WR	<b>Seal &amp; Wiper</b> 40.S485810 '10-13	<b>Oil Seal Set</b> 40.F485810 '10-13	<b>Dust Seal Set</b> 26.110162 '96 CR 26.110119 '97-01 CR 26.110162 '96-00 WR 26.110119 '01 WR 26.110133 '02-04 26.110146 '05-13	<b>Upper</b> 26.350080 '98-04 CR '98-13 WR	<b>Lower</b> 26.450044 '96-13	<b>Rear Shock Seal Head Kit</b> 26.810124 '01-04																		
<b>Main Jet</b> 47.090-580 '05-13 Mikuni	<b>Pilot Jet</b> 49.010-045 '05-13 Mikuni	<b>Carburetor Rebuild Kit</b> 55.10584 '99-04 CR '00-09 WR 55.10583 '00-13 WR	<b>Throttle Cable</b> 53.110055 '00-13	<b>Rear Pad Set</b> 37.102202 '95-05 CR 37.102202BX '92-13 WR 37.102202BX '92-13 WR Box of 10	<b>Rear Sprocket</b> 07.RA62097-46 07.RA62097-47 07.RA62097-48 07.RA62097-49 07.RA62097-50 07.RA62097-51 07.RA62097-52 '90-13	<b>7075-T6 Alloy</b> 07.RA62097-46 07.RA62097-47 07.RA62097-48 07.RA62097-49 07.RA62097-50 07.RA62097-51 07.RA62097-52 '90-13	<b>Lower Chain Roller</b> 33.0001 '96-13	<b>Upper Chain Roller</b> 33.0001 '96-13	<b>Ultralight Steel Rear Sprocket</b> 07.RS62097R-46 07.RS62097R-47 07.RS62097R-48 07.RS62097R-49 07.RS62097R-50 07.RS62097R-51 07.RS62097R-52 '90-13	<b>Sprocket Bolt Set</b> 07.SBSM825 '90-13	<b>Inner Cover / Case Gasket</b> 19.G6323 '14-16	<b>Cover Gasket</b> 19.G6324 '14-16	<b>Master Cylinder Rebuild Kit</b> 16.940003 '14-15 16.940000 '16-17 16.940012 '18-21	<b>Slave Cylinder Rebuild Kit</b> 16.950000 '14-16 16.950015 '17 16.950014 '18 16.950015 '19-21	<b>Complete Plate Set</b> 16.CPS64012 '14-23	<b>Friction Set</b> 16.S53011 '14-23	<b>Steel Set</b> 16.S53029 '14-23	<b>F/W Bearing</b> 23.S114002 '14-23	<b>R/W Bearing</b> 23.S112073 '14-22 23.S160023 '23	<b>F/W Spacer Kit</b> 26.710087 '14 26.710103 '15-23	<b>R/W Spacer Kit</b> 26.710084 '14-16 26.710102 '17-22	<b>Steering Bearing</b> 24.110026 '14-22	<b>Frontbrake Disc</b> 37.BD16290 '14-23	<b>Rearbrake Disc</b> 37.BD26190 '14-23	<b>Front Pad Set</b> 37.102202 '14-23 37.102202BX '14-23 Box of 10	<b>Rear Pad Set</b> 37.202302 '14-23 37.202302BX '14-23 Box of 10	<b>Front Caliper Rebuild Kit</b> 37.63046 '14-23	<b>Rear Caliper Rebuild Kit</b> 37.63048 '14-22	<b>Front Master Cylinder Rebuild Kit</b> 37.910035 '14-23	<b>Rear Master Cylinder Rebuild Kit</b> 37.910030 '14-23	<b>Brake Pedal Rebuild Kit</b> 37.RBPK001 '14-16 37.RBPK003 '17

**DIRT**  
APRILIA  
BETA  
BMW  
GAS GAS  
HONDA  
HUSABERG  
HUSQVARNA  
KAWASAKI  
KTM  
MOTO TM  
RIEJU  
SHERCO  
SUZUKI  
YAMAHA

**STREET**  
APRILIA  
CAGIVA  
HONDA  
KAWASAKI  
KTM  
SUZUKI  
YAMAHA

**ATV-UTV**  
CAN-AM  
GAS GAS  
HONDA  
KAWASAKI  
KTM  
POLARIS  
SUZUKI  
YAMAHA

**PWC**  
KAWASAKI  
POLARIS  
SEA DOO  
YAMAHA

**SNOW**  
ARCTIC CAT  
KAWASAKI  
LYNX  
MOTO-SKI  
POLARIS  
SKI DOO  
YAMAHA

**MOPED & SCOOTER**

**MISC. TECH. SPECIAL**



### HUSQVARNA

**DIRT**  
APRILIA  
BETA  
BMW  
GAS GAS  
HONDA  
HUSABERG  
HUSQVARNA  
KAWASAKI  
KTM  
MOTO TM  
RIEJU  
SHERCO  
SUZUKI  
YAMAHA

**STREET**  
APRILIA  
CAGIVA  
HONDA  
KAWASAKI  
KTM  
SUZUKI  
YAMAHA

**ATV-UTV**  
CAN-AM  
GAS GAS  
HONDA  
KAWASAKI  
KTM  
POLARIS  
SUZUKI  
YAMAHA

**PWC**  
KAWASAKI  
POLARIS  
SEA DOO  
YAMAHA

**SNOW**  
ARCTIC CAT  
KAWASAKI  
LYNX  
MOTO-SKI  
POLARIS  
SKI DOO  
YAMAHA

**MOPED & SCOOTER**

**MISC. TECH. SPECIAL**

TE 250 / TE 250 i 2-Stroke Please Note: Nikasil Piston Size -KTM Engine -Molycoated Skirt -Fuel Injection from 2018	<b>Piston Kit</b> 01.6343.A 01.6343.B 01.6343.C 01.6343.D '14-23	<b>SIZES (mm)</b> 66.34 66.35 66.36 66.37	<b>Ring Set</b> 02.6324 02.6324 02.6324 02.6324 '14-23	<b>Crank Bearing &amp; Seal Kit</b> 23.CBS63004 '14-23	<b>Con. Rod Kit</b> 03.6323 '14-23	<b>Complete</b> 34.6328 '14-16 34.6317 '17-22	<b>Valve Shim Assortment</b> 29.VSA948 '06-07 29.VSA948-2 '10-13 29.VSA748 '10-13 29.VSA748-2 '10-13
				<b>Bearing</b> 23.NJ207ECS '14-23 Left 23.6232X2 '14-23 Right	<b>S/E Bearing</b> 21.6320 '14-23	<b>Top-End</b> 35.6327 '14-16 35.6317 '17-19 35.6320 '20-23	
			<b>Pin</b> 04.1856 '14-23		<b>B/E Bearing</b> 22.243017F '14-23	<b>Head &amp; Base</b> 36.6307 '14-16 36.6317 '17-23	
			<b>Clips</b> 05.1812 '14-23	<b>Oilseal Set</b> 42.6320 '14-23	<b>Crankpin</b> 06.2459.6 '14-23	<b>Ignition Cover Gasket</b> 19.G96308 '14-16 19.G96317 '17-23	

Footnotes: \* Bearings Only \*\* Rubbers included

<b>Air Filter</b> 52.62011 '14-16 52.62016 '17-23	<b>Inner Cover / Case Gasket</b> 19.G6323 '14-16	<b>Complete Plate Set</b> 16.CPS64012 '14-23	<b>F/W Bearing</b> 23.S114002 '14-23	<b>Frontbrake Disc</b> 37.BD16290 '14-23	<b>Front Sprocket</b> 07.FS62093-12 07.FS62093-13 07.FS62093-14 07.FS62093-15 '14-23	<b>Chain</b> 07.RC520120C '14-23 MX 07.RC520120CG '14-23 MX Gold 07.RC520120XC '14-23 X-Ring 07.RC520120XCG '14-23 X-Ring Gold	<b>Swingarm</b> 26.210168 '14-16 26.210125 '17-23	<b>Seal &amp; Wiper</b> 40.S485789 '14
<b>Main Jet</b> 45.100-225 '14-16 Keihin 47.090-580 '17 Mikuni	<b>Cover Gasket</b> 19.G6324 '14-16 19.G6317 '17-23	<b>Friction Set</b> 16.S53011 '14-23	<b>R/W Bearing</b> 23.S112073 '14-23	<b>Rearbrake Disc</b> 37.BD26190 '14-23	<b>7075-T6 Alloy Rear Sprocket</b> 07.RA62090-48 07.RA62090-49 07.RA62090-50 07.RA62090-51 07.RA62090-52 '14-23	<b>Countershaft Seal Kit</b> 26.640003 '14-16 26.640001 '17-23	<b>Linkage</b> 26.110180 '14-23	<b>Oil Seal Set</b> 40.F4857.89 '14
<b>Pilot Jet</b> 46.040-085 '14-16 Keihin 49.010-045 '17 Mikuni	<b>Master Cylinder Rebuild Kit</b> 16.940000 '14-16 16.940012 '17-21	<b>Steel Set</b> 16.S53029 '14-23	<b>F/W Spacer Kit</b> 26.710087 '14-16 26.710103 '17-23	<b>Front Pad Set</b> 37.102202 '14-23 37.102202BX '14-23 Box of 10	<b>7075-T6 Alloy Rear Sprocket</b> 07.RA62090-48 07.RA62090-49 07.RA62090-50 07.RA62090-51 07.RA62090-52 '14-23	<b>Lower</b> 26.450066 '14-23	<b>Dust Seal Set</b> 40.F4857.8D '14	
<b>Carburetor Rebuild Kit</b> 55.10514 '14-16	<b>Slave Cylinder Rebuild Kit</b> 16.950000 '14-16 16.950015 '17-21		<b>R/W Spacer Kit</b> 26.710084 '14-16 26.710102 '17-23	<b>Rear Pad Set</b> 37.202302 '14-23 37.202302BX '14-23 Box of 10	<b>UltraLight Steel Rear Sprocket</b> 07.RS62090R-48 07.RS62090R-49 07.RS62090R-50 07.RS62090R-51 07.RS62090R-52 '14-23	<b>Upper</b> 26.450068 '14-23	<b>Bushing Set</b> 39.160082 '14	
<b>Throttle Cable</b> 53.110046 '14-16 53.112059 '17 53.112071 '18-19 53.112072 '20-22 53.112091 '23			<b>Steering Bearing</b> 24.110026 '14-23	<b>Front Caliper Rebuild Kit</b> 37.63046 '14-17	<b>Sprocket Bolt Set</b> 07.SBSM825 '14-23		<b>Rear Shock Seal Head Kit</b> 26.810127 '14-20	
<b>Water Pump Rebuild Kit</b> 57.6324 '14-16 57.6317 '17				<b>Rear Caliper Rebuild Kit</b> 37.63048 '14-16				
				<b>Front Master Cylinder Rebuild Kit</b> 37.910035 '14-17				
				<b>Rear Master Cylinder Rebuild Kit</b> 37.910030 '14-17				
				<b>Brake Pedal Rebuild Kit</b> 37.RBPK001 '14-16 37.RBPK003 '17				

**DIRT**  
APRILIA  
BETA  
BMW  
GAS GAS  
HONDA  
HUSABERG  
HUSQVARNA  
KAWASAKI  
KTM  
MOTO TM  
RIEJU  
SHERCO  
SUZUKI  
YAMAHA

**STREET**  
APRILIA  
CAGIVA  
HONDA  
KAWASAKI  
KTM  
SUZUKI  
YAMAHA

**ATV-UTV**  
CAN-AM  
GAS GAS  
HONDA  
KAWASAKI  
KTM  
POLARIS  
SUZUKI  
YAMAHA

**PWC**  
KAWASAKI  
POLARIS  
SEA DOO  
YAMAHA

**SNOW**  
ARCTIC CAT  
KAWASAKI  
LYNX  
MOTO-SKI  
POLARIS  
SKI DOO  
YAMAHA

**MOPED & SCOOTER**

**MISC. TECH. SPECIAL**



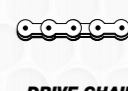

### HUSQVARNA

**DIRT**  
APRILIA  
BETA  
BMW  
GAS GAS  
HONDA  
HUSABERG  
HUSQVARNA  
KAWASAKI  
KTM  
MOTO TM  
RIEJU  
SHERCO  
SUZUKI  
YAMAHA

TE 250 4-Stroke Please Note: Nikasil Piston Size -Std. Compression 12.9:1 -Forged Piston	<b>Piston Kit</b> 01.6336.A 01.6336.B 01.6336.C '06-09	<b>Size</b> 75.96 75.97 75.98	<b>Ring Set</b> 02.6336 02.6336 02.6336 '06-09		<b>Con. Rod Kit</b> 03.6336 '06-09 03.6340 '10-13		<b>Valve Shim Assortment</b> 29.VSA948 '06-09 29.VSA948-2 '06-09 29.VSA748 '10-13 29.VSA748-2 '10-13
Please Note: Nikasil Piston Size -Std. Compression 13.6:1 -Forged Piston -Fuel Injection	01.6340.A 01.6340.B 01.6340.C '10-12	78.96 78.97 78.98	02.6340 02.6340 02.6340 '10-12		<b>Crankpin</b> 06.3056.5 '06-09 06.3256 '10-13		
Please Note: Nikasil Piston Size -Std. Compression 13.6:1 -Forged Piston -Fuel Injection	01.6341.A 01.6341.B 01.6341.C '13	78.95 78.96 78.97	02.6340 02.6340 02.6340 '13		<b>B/E Bearing</b> 22.303818F '06-09 22.324018F '10-13		

**STREET**  
APRILIA  
CAGIVA  
HONDA  
KAWASAKI  
KTM  
SUZUKI  
YAMAHA

			<b>Pin</b> 04.1436.5 '10-12				
			<b>Clips</b> 05.1612C '06-09 05.1410C '10-13				

**ATV-UTV**  
CAN-AM  
GAS GAS  
HONDA  
KAWASAKI  
KTM  
POLARIS  
SUZUKI  
YAMAHA

TXC 250 4-Stroke Please Note: Nikasil Piston Size -Std. Compression 12.9:1 -Forged Piston	<b>Piston Kit</b> 01.6336.A 01.6336.B 01.6336.C '08-09	<b>Size</b> 75.96 75.97 75.98	<b>Ring Set</b> 02.6336 02.6336 02.6336 '08-09		<b>Con. Rod Kit</b> 03.6336 '08-09 03.6340 '10-13		<b>Valve Shim Assortment</b> 29.VSA948 '08-09 29.VSA948-2 '08-09 29.VSA748 '10-13 29.VSA748-2 '10-13
Please Note: Nikasil Piston Size -Std. Compression 13.6:1 -Forged Piston -Fuel Injection	01.6340.A 01.6340.B 01.6340.C '10-12	78.96 78.97 78.98	02.6340 02.6340 02.6340 '10-12		<b>Crankpin</b> 06.3056.5 '08-09 06.3256 '10-13		
Please Note: Nikasil Piston Size -Std. Compression 13.6:1 -Forged Piston -Fuel Injection	01.6341.A 01.6341.B 01.6341.C '13	78.95 78.96 78.97	02.6340 02.6340 02.6340 '13		<b>B/E Bearing</b> 22.303818F '08-09 22.324018F '10-13		

**PWC**  
KAWASAKI  
POLARIS  
SEA DOO  
YAMAHA

			<b>Pin</b> 04.1436.5 '10-12				
			<b>Clips</b> 05.1612C '08-09 05.1410C '10-13				

**SNOW**  
ARCTIC CAT  
KAWASAKI  
LYNX  
MOTO-SKI  
POLARIS  
SKI DOO  
YAMAHA

**MOPED & SCOOTER**

**MISC. TECH. SPECIAL**

Footnotes: \* Bearings Only \*\* Rubbers included

**DIRT**  
APRILIA  
BETA  
BMW  
GAS GAS  
HONDA  
HUSABERG  
HUSQVARNA  
KAWASAKI  
KTM  
MOTO TM  
RIEJU  
SHERCO  
SUZUKI  
YAMAHA

<b>Air Filter</b> 52.63092 '02-13		<b>Friction Set</b> 16.S63001 '10-13	<b>F/W Bearing</b> 23.S114015 '03-11 23.S116061 '12-13	<b>Frontbrake Disc</b> 37.BD16200 '03-13	<b>Front Sprocket</b> 07.FS63000-12 '02-13 MX 07.FS63000-13 07.FS63000-14 07.FS63000-15 '02-09	<b>Chain</b> 07.RC520120C '02-13 MX 07.RC520120CG '02-13 MX Gold 07.RC520120XC '02-13 X-Ring 07.RC520120XCG '02-13 X-Ring Gold	<b>Swingarm</b> 26.210119 '03-07 26.210199 '08-13	<b>Seal &amp; Wiper</b> 40.S485810 '10-13
<b>Main Jet</b> 45.100-225 '05-07 Keihin		<b>Steel Set</b> 16.S63002 '10-13	<b>R/W Bearing</b> 23.S114020 '03-13	<b>Front Pad Set</b> 37.102202 '02-13 37.102202BX '02-13 Box of 10	<b>7075-T6 Alloy Rear Sprocket</b> 07.RA62097-46 07.RA62097-47 07.RA62097-48 07.RA62097-49 07.RA62097-50 07.RA62097-51 07.RA62097-52 '04-13	<b>Lower Chain Roller</b> 33.0001 '03-13	<b>Linkage</b> 26.110147 '05-07 26.110176 '08-13	<b>Oil Seal Set</b> 40.F485810 '10-13
<b>Pilot Jet</b> 46.040-085 '05-07 Keihin			<b>Steering Bearing</b> 24.110032 '03-07 24.110061 '08-13	<b>Rear Pad Set</b> 37.202302 '06-13 37.202302BX '06-13 Box of 10	<b>7075-T6 Alloy Rear Sprocket</b> 07.RA62097-46 07.RA62097-47 07.RA62097-48 07.RA62097-49 07.RA62097-50 07.RA62097-51 07.RA62097-52 '04-13	<b>Upper Chain Roller</b> 33.0001 '03-13	<b>Lower</b> 26.450044 '03-07 26.450062 '08-13	<b>Dust Seal Set</b> 40.F4858D '10-13
<b>Throttle Cable</b> 53.110053 '05-07 53.110052 '10-12				<b>Rear Pad Set</b> 37.202302 '06-13 37.202302BX '06-13 Box of 10	<b>UltraLight Steel Rear Sprocket</b> 07.RS62097R-46 07.RS62097R-47 07.RS62097R-48 07.RS62097R-49 07.RS62097R-50 07.RS62097R-51 07.RS62097R-52 '04-13	<b>Upper</b> 26.350080 '03-07 26.450068 '12-13	<b>Bushing Set</b> 39.160068 '10-13	<b>Rear Shock Seal Head Kit</b> 26.810124 '03-04
<b>Carburetor Rebuild Kit</b> 55.10521 '05-07					<b>Sprocket Bolt Set</b> 07.SBSM825 '04-13			
<b>Oil Filter</b> 54.63154 '02-07 1-Pce. 54.63154-50 '02-07 50-Pcs. 54.63563 '08-09 1-Pce. 54.63563-50 '08-09 50-Pcs. 54.13116 '10-13 1-Pce. 54.13116-50 '10-13 50-Pcs.								

**STREET**  
APRILIA  
CAGIVA  
HONDA  
KAWASAKI  
KTM  
SUZUKI  
YAMAHA

<b>Air Filter</b> 52.63092 '08-13		<b>Friction Set</b> 16.S63001 '10-13	<b>F/W Bearing</b> 23.S114015 '08-11 23.S116061 '12-13	<b>Frontbrake Disc</b> 37.BD16200 '11-13	<b>Front Sprocket</b> 07.FS63000-12 07.FS63000-13 07.FS63000-14 07.FS63000-15 '08-09	<b>Chain</b> 07.RC520120C '08-13 MX 07.RC520120CG '08-13 MX Gold 07.RC520120XC '08-13 X-Ring 07.RC520120XCG '08-13 X-Ring Gold	<b>Swingarm</b> 26.210199 '08-13	<b>Seal &amp; Wiper</b> 40.S485810 '10-13
<b>Main Jet</b> 45.100-225 '08-09 Keihin		<b>Steel Set</b> 16.S63002 '10-13	<b>R/W Bearing</b> 23.S114020 '08-13	<b>Rearbrake Disc</b> 37.BD26211 '11-13	<b>7075-T6 Alloy Rear Sprocket</b> 07.RA62097-46 07.RA62097-47 07.RA62097-48 07.RA62097-49 07.RA62097-50 07.RA62097-51 07.RA62097-52 '08-13	<b>Lower Chain Roller</b> 33.0001 '08-13	<b>Linkage</b> 26.110176 '08-13	<b>Oil Seal Set</b> 40.F485810 '10-13
<b>Pilot Jet</b> 46.040-085 '08-09 Keihin			<b>Steering Bearing</b> 24.110061 '08-13	<b>Front Pad Set</b> 37.102202 '08-13 37.102202BX '08-13 Box of 10	<b>7075-T6 Alloy Rear Sprocket</b> 07.RA62097-46 07.RA62097-47 07.RA62097-48 07.RA62097-49 07.RA62097-50 07.RA62097-51 07.RA62097-52 '08-13	<b>Upper Chain Roller</b> 33.0001 '08-13	<b>Lower</b> 26.450062 '08-13	<b>Dust Seal Set</b> 40.F4858D '10-13
<b>Carburetor Rebuild Kit</b> 55.10521 '08-09				<b>Rear Pad Set</b> 37.202302 '08-13 37.202302BX '08-13 Box of 10	<b>UltraLight Steel Rear Sprocket</b> 07.RS62097R-46 07.RS62097R-47 07.RS62097R-48 07.RS62097R-49 07.RS62097R-50 07.RS62097R-51 07.RS62097R-52 '08-13	<b>Upper</b> 26.350080 '03-07 26.450068 '10-13	<b>Bushing Set</b> 39.160068 '10-13	<b>Rear Shock Seal Head Kit</b> 26.810124 '03-04
<b>Throttle Cable</b> 53.110053 '08-09 53.110052 '10-13					<b>Sprocket Bolt Set</b> 07.SBSM825 '08-13			
<b>Oil Filter</b> 54.63563 '08-09 1-Pce. 54.63563-50 '08-09 50-Pcs. 54.13116 '10-13 1-Pce. 54.13116-50 '10-13 50-Pcs.								

**ATV-UTV**  
CAN-AM  
GAS GAS  
HONDA  
KAWASAKI  
KTM  
POLARIS  
SUZUKI  
YAMAHA

**PWC**  
KAWASAKI  
POLARIS  
SEA DOO  
YAMAHA

**SNOW**  
ARCTIC CAT  
KAWASAKI  
LYNX  
MOTO-SKI  
POLARIS  
SKI DOO  
YAMAHA

**MOPED & SCOOTER**

**MISC. TECH. SPECIAL**





### HUSQVARNA

**DIRT**  
APRILIA  
BETA  
BMW  
GAS GAS  
HONDA  
HUSABERG  
HUSQVARNA  
KAWASAKI  
KTM  
MOTO TM  
RIEJU  
SHERCO  
SUZUKI  
YAMAHA

FC 250 4-Stroke Please Note: Nikasil Piston Size -Std. Compression 13.9:1 -Forged Piston -Fuel Injection -KTM Engine	Piston Kit 01.6333.A 01.6333.B 01.6333.C '14-15	Size (mm) 77.96 77.97 77.98	Ring Set 02.6333 02.6333 02.6333 '14-15	Crank Bearing & Seal Kit 23.CBS63013 '14-15 23.CBS63016 '16-18 23.CBS63017 '19-23	Con. Rod Kit 03.6333 '14-15 03.6337 '16-22 03.6343 '23	Complete 34.6333 '14-15 34.6316 '16-22 <b>Top-End</b> 35.6333 '14-15 35.6316 '16-22 35.6343 '23 <b>Head &amp; Base</b> 36.6313 '14-15 36.6316 '16-22 36.6343 '23	Cam Chain 31.6351 '14-15 31.6356 '16-22 31.6363 '23	Valve 28.6333-1 '14-22 Exhaust Titanium 28.6343-1 '23 Exhaust Titanium 28.6333-2 '14-23 Intake Titanium <b>TI-Steel Conversion Set</b> 28.SES6333-1 '14-15 Exhaust 28.SIS6333-2 '14-15 Intake
Please Note: Nikasil Piston Size -Std. Compression 14.4:1 -Forged Piston -Fuel Injection -KTM Engine	01.6347.A 01.6347.B 01.6347.C '16-22	77.96 77.97 77.98	02.6347 02.6347 02.6347 '16-22	<b>Bearing</b> 23.NJ206EPC-3 '14-23 2x	<b>Crankpin</b> 06.3056 '14-15 06.3056-2 '16-22 06.3055.4 '23	<b>Head &amp; Base</b> 36.6313 '14-15 36.6316 '16-22 36.6343 '23	<b>Valve Shim Assortment</b> 29.VSA890 '14-23 29.VSA890-2 '14-23	<b>Valve Seal</b> 35.VS028 '14-23 4x
Please Note: Nikasil Piston Size -Std. Compression 14.5:1 -Forged Piston -Fuel Injection -KTM Engine	01.6348.A 01.6348.B 01.6348.C '23	80.96 80.97 80.98	TBA TBA TBA '23	<b>Oilseal Set</b> 42.6351 '14-15 42.6336 '16-18 <b>Oilseal</b> 41.6-405561 '19-23		<b>Ignition Cover Gasket</b> 19.G96351 '14-15 19.G96316 '16-22		
			<b>Clips</b> 05.1612C '14-22					

Footnotes: \* Bearings Only \*\* Rubbers included

Air Filter 52.62011 '14-15 52.62016 '16-22 52.62023 '23	Cover Gasket 19.G6351 '14-15 19.G6316 '16-22	Complete Plate Set 16.CPS63011 '14-15 16.CPS63019 '19-23	F/W Bearing 23.S114002 '14-23	Frontbrake Disc 37.BD16290 '14-23	Front Sprocket 07.FS62093-12 07.FS62093-13 07.FS62093-14 07.FS62093-15 '14-23	Chain 07.RC520120C '14-23 MX 07.RC520120CG '14-23 MX Gold 07.RC520120XC '14-23 X-Ring 07.RC520120XCG '14-23 X-Ring Gold	Swingarm 26.210168 '14-15 26.210125 '16-23	Seal & Wiper 40.S4857.89 '14
<b>Throttle Cable</b> 53.110045 '14-15 53.112060 '16-18 53.112073 '19-20 53.112090 '23	<b>Master Cylinder Rebuild Kit</b> 16.940000 '14-15 16.940011 '16-18 16.940012 '19-20 16.940011 '21-22	<b>Friction Set</b> 16.S53011 '14-15 16.S53016 '16-23 <b>Steel Set</b> 16.S53029 '14-15 16.S53027 '16-23	<b>R/W Bearing</b> 23.S112073 '14-22 23.S160023 '23	<b>Rearbrake Disc</b> 37.BD26190 '14-23	<b>7075-T6 Alloy Rear Sprocket</b> 07.RA62090-48 07.RA62090-49 07.RA62090-50 07.RA62090-51 07.RA62090-52 '14-23	<b>Countershaft Seal Kit</b> 26.640001 '14-23	<b>Lower</b> 26.450066 '14-21 <b>Upper</b> 26.450068 '14-23	<b>Oil Seal Set</b> 40.F4857.89 '14 <b>Dust Seal Set</b> 40.F4857.8D '14 <b>Bushing Set</b> 39.160082 '14 39.160122 '15-16 39.160128 '17 <b>Rear Shock Seal Head Kit</b> 26.810127 '14-20
<b>Oil Filter</b> 54.63652 '14-23 1-Pce. 54.63652-50 '19-22 '14-23 50-Pcs.	<b>Slave Cylinder Rebuild Kit</b> 16.950001 '14-15 16.950015 '16-21		<b>R/W Spacer Kit</b> 26.710087 '14 26.710103 '15-23	<b>Front Pad Set</b> 37.102202 '14-23 37.102202BX '14-23 Box of 10	<b>7075-T6 Alloy Rear Sprocket</b> 07.RA62090-48 07.RA62090-49 07.RA62090-50 07.RA62090-51 07.RA62090-52 '14-23			
<b>Water Pump Rebuild Kit</b> 57.6323 '14-15 57.6316 '16-19			<b>Steering Bearing</b> 24.110026 '14-22	<b>Rear Pad Set</b> 37.202302 '14-23 37.202302BX '14-23 Box of 10	<b>UltraLight Steel Rear Sprocket</b> 07.RS62090R-48 07.RS62090R-49 07.RS62090R-50 07.RS62090R-51 07.RS62090R-52 '14-23			
				<b>Rear Caliper Rebuild Kit</b> 37.63046 '14-23	<b>Sprocket Bolt Set</b> 07.SBSM825 '14-23			
				<b>Front Master Cylinder Rebuild Kit</b> 37.910035 '14-23				
				<b>Rear Master Cylinder Rebuild Kit</b> 37.910030 '14-23				
				<b>Brake Pedal Rebuild Kit</b> 37.RBPK001 '14-15 37.RBPK003 '16-17				

**DIRT**  
APRILIA  
BETA  
BMW  
GAS GAS  
HONDA  
HUSABERG  
HUSQVARNA  
KAWASAKI  
KTM  
MOTO TM  
RIEJU  
SHERCO  
SUZUKI  
YAMAHA

**STREET**  
APRILIA  
CAGIVA  
HONDA  
KAWASAKI  
KTM  
SUZUKI  
YAMAHA

**ATV-UTV**  
CAN-AM  
GAS GAS  
HONDA  
KAWASAKI  
KTM  
POLARIS  
SUZUKI  
YAMAHA

**PWC**  
KAWASAKI  
POLARIS  
SEA DOO  
YAMAHA

**SNOW**  
ARCTIC CAT  
KAWASAKI  
LYNX  
MOTO-SKI  
POLARIS  
SKI DOO  
YAMAHA

**MOPED & SCOOTER**

**MISC. TECH. SPECIAL**

**ATV-UTV**  
CAN-AM  
GAS GAS  
HONDA  
KAWASAKI  
KTM  
POLARIS  
SUZUKI  
YAMAHA

**PWC**  
KAWASAKI  
POLARIS  
SEA DOO  
YAMAHA

**SNOW**  
ARCTIC CAT  
KAWASAKI  
LYNX  
MOTO-SKI  
POLARIS  
SKI DOO  
YAMAHA

**MOPED & SCOOTER**

**MISC. TECH. SPECIAL**





### HUSQVARNA

**DIRT**  
APRILIA  
BETA  
BMW  
GAS GAS  
HONDA  
HUSABERG  
HUSQVARNA  
KAWASAKI  
KTM  
MOTO TM  
RIEJU  
SHERCO  
SUZUKI  
YAMAHA

FE 250 4-Stroke Please Note: Nikasil Piston Size -Std. Compression 13.9:1 -Forged Piston -Fuel Injection -KTM Engine	<b>Piston Kit</b> 01.6333.A 01.6333.B 01.6333.C '14-23	<b>Size</b> 77.96 77.97 77.98	<b>Ring Set</b> 02.6333 02.6333 02.6333 '14-23	<b>Crank Bearing &amp; Seal Kit</b> 23.CBS63013 '14-15 23.CBS63017 '16-23	<b>Con. Rod Kit</b> 03.6333 '14-16 03.6337 '17-23	<b>Complete</b> 34.6334 '14-16 34.6316 '17	<b>Cam Chain</b> 31.6351 '14-16 31.6356 '17-23	<b>Valve</b> 28.6333-1 '14-23 Exhaust Titanium 28.6333-2 '14-23 Intake Titanium	<b>Valve Shim Assortment</b> 29.VSA890 '14-23 29.VSA890-2 '14-23	<b>TI-Steel Conversion Set</b> 28.SES6334-1 '14-16 Exhaust 28.SIS6334-2 '14-16 Intake
			<b>Clips</b> 05.1612C '14-23	<b>Bearing</b> 23.NJ206EPC-3 '14-23 2x	<b>Crankpin</b> 06.3056 '14-16 06.3056-2 '17-23	<b>Top-End</b> 35.6333 '14-16 35.6316 '17	<b>Valve Shim Assortment</b> 29.VSA890 '14-23 29.VSA890-2 '14-23			<b>Head &amp; Base</b> 36.6313 '14-16 36.6316 '17-19
				<b>Oilseal Set</b> 42.6351 '14-15						<b>Valve Seal</b> 35.VS028 '14-23 4x
				<b>Oilseal</b> 41.6-405561 '16-23 Left						<b>Ignition Cover Gasket</b> 19.G96314 '14-16 19.G96316 '17-23

**STREET**  
APRILIA  
CAGIVA  
HONDA  
KAWASAKI  
KTM  
SUZUKI  
YAMAHA

**ATV-UTV**  
CAN-AM  
GAS GAS  
HONDA  
KAWASAKI  
KTM  
POLARIS  
SUZUKI  
YAMAHA

**PWC**  
KAWASAKI  
POLARIS  
SEA DOO  
YAMAHA

**SNOW**  
ARCTIC CAT  
KAWASAKI  
LYNX  
MOTO-SKI  
POLARIS  
SKI DOO  
YAMAHA

**MOPED & SCOOTER**

**MISC. TECH. SPECIAL**

Footnotes: \* Bearings Only \*\* Rubbers included

**DIRT**  
APRILIA  
BETA  
BMW  
GAS GAS  
HONDA  
HUSABERG  
HUSQVARNA  
KAWASAKI  
KTM  
MOTO TM  
RIEJU  
SHERCO  
SUZUKI  
YAMAHA

**STREET**  
APRILIA  
CAGIVA  
HONDA  
KAWASAKI  
KTM  
SUZUKI  
YAMAHA

**ATV-UTV**  
CAN-AM  
GAS GAS  
HONDA  
KAWASAKI  
KTM  
POLARIS  
SUZUKI  
YAMAHA

**PWC**  
KAWASAKI  
POLARIS  
SEA DOO  
YAMAHA

**SNOW**  
ARCTIC CAT  
KAWASAKI  
LYNX  
MOTO-SKI  
POLARIS  
SKI DOO  
YAMAHA

**MOPED & SCOOTER**

**MISC. TECH. SPECIAL**

<b>Air Filter</b> 52.62011 '14-16 52.62016 '17-23	<b>Cover Gasket</b> 19.G6351 '14-16 19.G6316 '17-23	<b>Complete Plate Set</b> 16.CPS64012 '14-23	<b>F/W Bearing</b> 23.S114002 '14-23	<b>Frontbrake Disc</b> 37.BD16290 '14-23	<b>Front Sprocket</b> 07.FS62093-12 07.FS62093-13 07.FS62093-14 07.FS62093-15 '14-23	<b>Chain</b> 07.RC520120C '14-23 MX 07.RC520120CG '14-23 MX Gold 07.RC520120XC '14-23 X-Ring 07.RC520120XCG '14-23 X-Ring Gold	<b>Swingarm</b> 26.210168 '14-16 26.210125 '17-23	<b>Seal &amp; Wiper</b> 40.S4857.89 '14
<b>Throttle Cable</b> 53.110045 '14-16 53.112060 '17-19 53.112073 '20-23	<b>Master Cylinder Rebuild Kit</b> 16.940000 '14-16 16.940012 '17-20	<b>Friction Set</b> 16.S53011 '14-23	<b>R/W Bearing</b> 23.S112073 '14-23	<b>Rearbrake Disc</b> 37.BD26190 '14-23	<b>7075-T6 Alloy Rear Sprocket</b> 07.RA62090-48 07.RA62090-49 07.RA62090-50 07.RA62090-51 07.RA62090-52 '14-23	<b>Countershaft Seal Kit</b> 26.640001 '14-23	<b>Linkage</b> 26.110180 '14-23	<b>Oil Seal Set</b> 40.F4857.89 '14
<b>Oil Filter</b> 54.63652 '14-23 1-Pce. 54.63652-50 '14-23 50-Pcs.	<b>Slave Cylinder Rebuild Kit</b> 16.950001 '14-16 16.950015 '17-20	<b>Steel Set</b> 16.S53029 '14-23	<b>F/W Spacer Kit</b> 26.710087 '14-15 26.710103 '16-23	<b>Front Pad Set</b> 37.102202 '14-23 37.102202BX '14-23 Box of 10	<b>7075-T6 Alloy Rear Sprocket</b> 07.RS62090R-48 07.RS62090R-49 07.RS62090R-50 07.RS62090R-51 07.RS62090R-52 '14-23	<b>Lower</b> 26.450066 '14-23	<b>Dust Seal Set</b> 40.F4857.8D '14	
<b>Water Pump Rebuild Kit</b> 57.6323 '14-16 57.6316 '17			<b>R/W Spacer Kit</b> 26.710084 '14-23	<b>Rear Pad Set</b> 37.202302 '14-23 37.202302BX '14-23 Box of 10	<b>Ultralight Steel Rear Sprocket</b> 07.RS62090R-48 07.RS62090R-49 07.RS62090R-50 07.RS62090R-51 07.RS62090R-52 '14-23	<b>Upper</b> 26.450068 '14-23	<b>Bushing Set</b> 39.160082 '14	
			<b>Steering Bearing</b> 24.110026 '14-23	<b>Front Caliper Rebuild Kit</b> 37.63046 '14-17	<b>Sprocket Bolt Set</b> 07.SBSM825 '14-23		<b>Rear Shock Seal Head Kit</b> 26.810127 '14-20	
				<b>Rear Caliper Rebuild Kit</b> 37.63048 '14-16				
				<b>Front Master Cylinder Rebuild Kit</b> 37.910035 '14-17				
				<b>Rear Master Cylinder Rebuild Kit</b> 37.910030 '14-17				
				<b>Brake Pedal Rebuild Kit</b> 37.RBPK001 '14-16 37.RBPK003 '17				

<b>Air Filter</b> 52.63092 '09-13	<b>Clutch Cable</b> 53.121020 '08-12	<b>Friction Set</b> 16.S13010 '09-13	<b>F/W Bearing</b> 23.S114015 '09-13	<b>Frontbrake Disc</b> 37.BD16200 '09-13	<b>Front Sprocket</b> 07.FS63000-12 07.FS63000-13 07.FS63000-14 07.FS63000-15 '09-13	<b>Chain</b> 07.RC520120C '09-13 MX 07.RC520120CG '09-13 MX Gold 07.RC520120XC '09-13 X-Ring 07.RC520120XCG '09-13 X-Ring Gold	<b>Swingarm</b> 26.210119 '09-13	<b>Seal &amp; Wiper</b> 40.S485810 '10-13
<b>Main Jet</b> 47.090-580 '09-13 Mikuni		<b>Steel Set</b> 16.S14016 '09-13	<b>R/W Bearing</b> 23.S114020 '09-13	<b>Front Pad Set</b> 37.102202 '09-13 37.102202BX '09-13 Box of 10	<b>7075-T6 Alloy Rear Sprocket</b> 07.RA62097-46 07.RA62097-47 07.RA62097-48 07.RA62097-49 07.RA62097-50 07.RA62097-51 07.RA62097-52 '09-13	<b>Upper Chain Roller</b> 33.0001 '09-13	<b>Linkage</b> 26.110146 '09-13	<b>Oil Seal Set</b> 40.F485810 '10-13
<b>Pilot Jet</b> 49.010-045 '09-13 Mikuni			<b>Steering Bearing</b> 24.110061 '09-13	<b>Rear Pad Set</b> 37.202302 '09-13 37.202302BX '09-13 Box of 10	<b>Ultralight Steel Rear Sprocket</b> 07.RS62097R-46 07.RS62097R-47 07.RS62097R-48 07.RS62097R-49 07.RS62097R-50 07.RS62097R-51 07.RS62097R-52 '09-13	<b>Lower</b> 26.450044 '09-13	<b>Dust Seal Set</b> 40.F4858D '10-13	
<b>Carburetor Rebuild Kit</b> 55.10584 '08-09 55.10583 '10-13					<b>Sprocket Bolt Set</b> 07.SBSM825 '09-13		<b>Bushing Set</b> 39.160068 '10-13	
<b>Throttle Cable</b> 53.110055 '08-13								

**SNOW**  
ARCTIC CAT  
KAWASAKI  
LYNX  
MOTO-SKI  
POLARIS  
SKI DOO  
YAMAHA

**MOPED & SCOOTER**

**MISC. TECH. SPECIAL**







### HUSQVARNA

**DIRT**  
APRILIA  
BETA  
BMW  
GAS GAS  
HONDA  
HUSABERG  
HUSQVARNA  
KAWASAKI  
KTM  
MOTO TM  
RIEJU  
SHERCO  
SUZUKI  
YAMAHA

Model	Piston Kit	Size (mm)	Ring Set	CrankBearing & Seal Kit	Con. Rod Kit	Complete
TE 300 / TE 300 i 2-Stroke Please Note: Nikasil Piston Size -KTM Engine	01.6394.A 01.6394.B 01.6394.C '14-16	71.94 71.95 71.96	02.6394 02.6394 02.6394 '14-16	23.CBS63004 '14-23	03.6323 '14-23	34.6348 '14-16 34.6317 '17-22
Please Note: Nikasil Piston Size -KTM Engine -Forged Piston	01.6387.A 01.6387.B 01.6387.C '17	71.94 71.95 71.96	02.6396 02.6396 02.6396 '17	23.NJ207ECS '14-23 Left 23.6232X2 '14-23 Right	21.6320 '14-23	<b>Top-End</b> 35.6348 '14-16 35.6347 '17-19 35.6350 '20-22 35.6353 '23
Please Note: Nikasil Piston Size -KTM Engine -Forged Piston -Fuel Injection from 2018	01.6388.A 01.6388.B 01.6388.C '18-23	71.94 71.95 71.96	02.6396 02.6396 02.6396 '18-23	<b>Oilseal Set</b> 42.6320 '14-23	<b>Crankpin</b> 06.2459.6 '14-23	<b>Head &amp; Base</b> 36.6308 '14-16 36.6327 '17-22 36.6333 '23  <b>Ignition Cover Gasket</b> 19.G96308 '14-16 19.G96317 '17-23
			<b>Clips</b> 05.1815 '14-16 05.1812 '17-23			

**STREET**  
APRILIA  
CAGIVA  
HONDA  
KAWASAKI  
KTM  
SUZUKI  
YAMAHA

**ATV-UTV**  
CAN-AM  
GAS GAS  
HONDA  
KAWASAKI  
KTM  
POLARIS  
SUZUKI  
YAMAHA

**PWC**  
KAWASAKI  
POLARIS  
SEA DOO  
YAMAHA

**SNOW**  
ARCTIC CAT  
KAWASAKI  
LYNX  
MOTO-SKI  
POLARIS  
SKI DOO  
YAMAHA

**MOPED & SCOOTER**

**MISC. TECH. SPECIAL**

Footnotes: \* Bearings Only \*\* Rubbers included

**DIRT**  
APRILIA  
BETA  
BMW  
GAS GAS  
HONDA  
HUSABERG  
HUSQVARNA  
KAWASAKI  
KTM  
MOTO TM  
RIEJU  
SHERCO  
SUZUKI  
YAMAHA

**STREET**  
APRILIA  
CAGIVA  
HONDA  
KAWASAKI  
KTM  
SUZUKI  
YAMAHA

**ATV-UTV**  
CAN-AM  
GAS GAS  
HONDA  
KAWASAKI  
KTM  
POLARIS  
SUZUKI  
YAMAHA

**PWC**  
KAWASAKI  
POLARIS  
SEA DOO  
YAMAHA

**SNOW**  
ARCTIC CAT  
KAWASAKI  
LYNX  
MOTO-SKI  
POLARIS  
SKI DOO  
YAMAHA

**MOPED & SCOOTER**

**MISC. TECH. SPECIAL**

Model	Air Filter	Inner Cover / Case Gasket	Complete Plate Set	F/W Bearing	Frontbrake Disc	Front Sprocket	Chain	Swingarm	Seal & Wiper
Air Filter 52.62011 '14-16 52.62016 '17-23	Inner Cover / Case Gasket 19.G6323 '14-17	Complete Plate Set 16.CPS64012 '14-23	F/W Bearing 23.S114002 '14-23	Frontbrake Disc 37.BD16290 '14-23	Front Sprocket 07.FS62093-12 07.FS62093-13 07.FS62093-14 07.FS62093-15 '14-23	Chain 07.RC520120C '14-23 MX 07.RC520120CG '14-23 X-Ring 07.RC520120XCG '14-23 X-Ring Gold	Swingarm 26.210168 '14-16 26.210125 '17-23	Seal & Wiper 40.S4857.89 '14	
Main Jet 45.100-225 '14-16 Keihin 47.090-580 '17 Mikuni	Cover Gasket 19.G6324 '14-16 19.G6317 '17-21	Friction Set 16.S53011 '14-23	R/W Bearing 23.S112073 '14-23	Rearbrake Disc 37.BD26190 '14-23	7075-T6 Alloy Rear Sprocket 07.RA62090-48 07.RA62090-49 07.RA62090-50 07.RA62090-51 07.RA62090-52 '14-23 Box of 10	Countershaft Seal Kit 26.640003 '14-16 26.640001 '17-23	Linkage 26.110180 '14-23	Oil Seal Set 40.F4857.89 '14	
Pilot Jet 46.040-085 '14-16 Keihin 49.010-045 '17 Mikuni	Master Cylinder Rebuild Kit 16.940000 '14-16 16.940012 '17-20	Steel Set 16.S53029 '14-23	F/W Spacer Kit 26.710087 '14-15 26.710103 '16-23	Front Pad Set 37.102202 '14-23	Ultralight Steel Rear Sprocket 07.RS62090R-48 07.RS62090R-49 07.RS62090R-50 07.RS62090R-51 07.RS62090R-52 '14-23	Lower 26.450066 '14-23	Dust Seal Set 40.F4857.8D '14		
Carburetor Rebuild Kit 55.10514 '14-16	Slave Cylinder Rebuild Kit 16.950000 '14-16 16.950015 '17-20	Steering Bearing 24.110026 '14-23	R/W Spacer Kit 26.710084 '14-23	Rear Pad Set 37.202302 '14-23 37.202302BX '14-23 Box of 10	Rear Sprocket Bolt Set 07.SBSM825 '14-23	Upper 26.450068 '14-23	Bushing Set 39.160082 '14		
Throttle Cable 53.110046 '14-16 53.112059 '17 53.112071 '18-19 53.112072 '20-22 53.112091 '23	Water Pump Rebuild Kit 57.6324 '14-16 57.6317 '17	Front Caliper Rebuild Kit 37.63046 '14-17	Steering Bearing 24.110026 '14-23	Front Master Cylinder Rebuild Kit 37.910035 '14-17	Rear Caliper Rebuild Kit 37.63048 '14-16	Rear Shock Seal Head Kit 26.810127 '14-20			
		Rear Master Cylinder Rebuild Kit 37.910030 '14-17		Brake Pedal Rebuild Kit 37.RBPK001 '14-16 37.RBPK003 '17					



### HUSQVARNA

**DIRT**  
APRILIA  
BETA  
BMW  
GAS GAS  
HONDA  
HUSABERG  
HUSQVARNA  
KAWASAKI  
KTM  
MOTO TM  
RIEJU  
SHERCO  
SUZUKI  
YAMAHA

TE 310 4-Stroke Please Note: Nikasil Piston Size -Std. Compression 12.9:1 -Forged Piston -Fuel Injection	<b>Piston Kit</b> 01.6339.A 01.6339.B 01.6339.C '09-10	<b>Size</b> 82.96 82.97 82.98	<b>Ring Set</b> 02.6339 02.6339 02.6339 '09-10		<b>Con. Rod Kit</b> 03.6336 '09-12  <b>Crankpin</b> 06.3056.5 '09-12		<b>Valve Shim Assortment</b> 29.VSA748 '09-13 29.VSA748-2 '09-13
4-Stroke Please Note: Nikasil Piston Size -Std. Compression 13.0:1 -Forged Piston -Fuel Injection	01.6342.A 01.6342.B 01.6342.C '11-12	81.96 81.97 81.98	02.6342 02.6342 02.6342 '11-12		<b>B/E Bearing</b> 22.303818F '09-12		
			<b>Clips</b> 05.1612C '09-12				

**STREET**  
APRILIA  
CAGIVA  
HONDA  
KAWASAKI  
KTM  
SUZUKI  
YAMAHA

**ATV-UTV**  
CAN-AM  
GAS GAS  
HONDA  
KAWASAKI  
KTM  
POLARIS  
SUZUKI  
YAMAHA

TXC 310 4-Stroke Please Note: Nikasil Piston Size -Std. Compression 13.0:1 -Forged Piston -Fuel Injection	<b>Piston Kit</b> 01.6342.A 01.6342.B 01.6342.C '12	<b>Size</b> 81.96 81.97 81.98	<b>Ring Set</b> 02.6342 02.6342 02.6342 '12		<b>Con. Rod Kit</b> 03.6336 '12-13  <b>Crankpin</b> 06.3056.5 '12-13		<b>Valve Shim Assortment</b> 29.VSA748 '12-13 29.VSA748-2 '12-13
			<b>Clips</b> 05.1612C '12		<b>B/E Bearing</b> 22.303818F '12-13		

**PWC**  
KAWASAKI  
POLARIS  
SEA DOO  
YAMAHA

**SNOW**  
ARCTIC CAT  
KAWASAKI  
LYNX  
MOTO-SKI  
POLARIS  
SKI DOO  
YAMAHA

**MOPED & SCOOTER**

**MISC. TECH. SPECIAL**

Footnotes: \* Bearings Only \*\* Rubbers included

**DIRT**  
APRILIA  
BETA  
BMW  
GAS GAS  
HONDA  
HUSABERG  
HUSQVARNA  
KAWASAKI  
KTM  
MOTO TM  
RIEJU  
SHERCO  
SUZUKI  
YAMAHA

**STREET**  
APRILIA  
CAGIVA  
HONDA  
KAWASAKI  
KTM  
SUZUKI  
YAMAHA

**ATV-UTV**  
CAN-AM  
GAS GAS  
HONDA  
KAWASAKI  
KTM  
POLARIS  
SUZUKI  
YAMAHA

**PWC**  
KAWASAKI  
POLARIS  
SEA DOO  
YAMAHA

**SNOW**  
ARCTIC CAT  
KAWASAKI  
LYNX  
MOTO-SKI  
POLARIS  
SKI DOO  
YAMAHA

**MOPED & SCOOTER**

**MISC. TECH. SPECIAL**

<b>Air Filter</b> 52.63092 '12-13	<b>Friction Set</b> 16.S63001 '11-13	<b>F/W Bearing</b> 23.S114015 '09-11 23.S116061 '12-13	<b>Frontbrake Disc</b> 37.BD16200 '09-13	<b>Front Sprocket</b> 07.FS63000-12 07.FS63000-13 07.FS63000-14 07.FS63000-15 '09-10 07.FS63009-13 07.FS63009-14 07.FS63009-15 '11-13	<b>Chain</b> 07.RC520120C '09-13 MX 07.RC520120CG '09-13 MX Gold 07.RC520120XC '09-13 X-Ring 07.RC520120XCG '09-13 X-Ring Gold	<b>Swingarm</b> 26.210199 '09-13	<b>Seal &amp; Wiper</b> 40.S485810 '11-13
<b>Throttle Cable</b> 53.110053 '10 53.110052 '11-13	<b>Steel Set</b> 16.S63002 '11-13	<b>R/W Bearing</b> 23.S114020 '09-13	<b>Front Pad Set</b> 37.102202 '09-13 37.102202BX '09-13 Box of 10	<b>7075-T6 Alloy Rear Sprocket</b> 07.RA62097-46 07.RA62097-47 07.RA62097-48 07.RA62097-49 07.RA62097-50 07.RA62097-51 07.RA62097-52 '09-13	<b>Lower Chain Roller</b> 33.0001 '09-13	<b>Linkage</b> 26.110176 '09-13	<b>Oil Seal Set</b> 40.F485810 '11-13
<b>Oil Filter</b> 54.63563 '09-10 1-Pce. 54.63563-50 '09-10 50-Pcs. 54.13116 '11-13 1-Pce. 54.13116-50 '11-13 50-Pcs.		<b>Steering Bearing</b> 24.110061 '09-13	<b>Rear Pad Set</b> 37.202302 '09-13 37.202302BX '09-13 Box of 10	<b>7075-T6 Alloy Rear Sprocket</b> 07.RA62097-46 07.RA62097-47 07.RA62097-48 07.RA62097-49 07.RA62097-50 07.RA62097-51 07.RA62097-52 '09-13	<b>Upper Chain Roller</b> 33.0001 '09-13	<b>Lower</b> 26.450062 '09-13	<b>Dust Seal Set</b> 40.F4858D '11-13
			<b>Rear Pad Set</b> 37.202302 '12-13 37.202302BX '12-13 Box of 10	<b>Ultralight Steel Rear Sprocket</b> 07.RS62097R-46 07.RS62097R-47 07.RS62097R-48 07.RS62097R-49 07.RS62097R-50 07.RS62097R-51 07.RS62097R-52 '09-13	<b>Upper Chain Roller</b> 33.0001 '12-13	<b>Bushing Set</b> 39.160068 '10-13	
			<b>Sprocket Bolt Set</b> 07.SBSM825 '09-13	<b>Sprocket Bolt Set</b> 07.SBSM825 '09-13			

<b>Air Filter</b> 52.63092 '12-13	<b>Friction Set</b> 16.S63001 '12-13	<b>F/W Bearing</b> 23.S116061 '12-13	<b>Frontbrake Disc</b> 37.BD16200 '12-13	<b>Front Sprocket</b> 07.FS63009-13 07.FS63009-14 07.FS63009-15 '12-13	<b>Chain</b> 07.RC520120C '12-13 MX 07.RC520120CG '12-13 MX Gold 07.RC520120XC '12-13 X-Ring 07.RC520120XCG '12-13 X-Ring Gold	<b>Swingarm</b> 26.210199 '12-13	<b>Seal &amp; Wiper</b> 40.S485810 '12-13
<b>Throttle Cable</b> 53.110052 '12-13	<b>Steel Set</b> 16.S63002 '11-13	<b>R/W Bearing</b> 23.S114020 '12-13	<b>Rearbrake Disc</b> 37.BD26211 '12-13	<b>7075-T6 Alloy Rear Sprocket</b> 07.RA62097-46 07.RA62097-47 07.RA62097-48 07.RA62097-49 07.RA62097-50 07.RA62097-51 07.RA62097-52 '12-13	<b>Lower Chain Roller</b> 33.0001 '12-13	<b>Linkage</b> 26.110176 '12-13	<b>Oil Seal Set</b> 40.F485810 '12-13
<b>Oil Filter</b> 54.13116 '12-13 1-Pce. 54.13116-50 '12-13 50-Pcs.		<b>Steering Bearing</b> 24.110061 '12-13	<b>Front Pad Set</b> 37.102202 '12-13 37.102202BX '12-13 Box of 10	<b>7075-T6 Alloy Rear Sprocket</b> 07.RA62097-46 07.RA62097-47 07.RA62097-48 07.RA62097-49 07.RA62097-50 07.RA62097-51 07.RA62097-52 '12-13	<b>Lower Chain Roller</b> 33.0001 '12-13	<b>Lower</b> 26.450062 '12-13	<b>Dust Seal Set</b> 40.F4858D '12-13
			<b>Rear Pad Set</b> 37.202302 '12-13 37.202302BX '12-13 Box of 10	<b>Ultralight Steel Rear Sprocket</b> 07.RS62097R-46 07.RS62097R-47 07.RS62097R-48 07.RS62097R-49 07.RS62097R-50 07.RS62097R-51 07.RS62097R-52 '12-13	<b>Upper Chain Roller</b> 33.0001 '12-13	<b>Bushing Set</b> 39.160068 '12-13	
			<b>Sprocket Bolt Set</b> 07.SBSM825 '12-13	<b>Sprocket Bolt Set</b> 07.SBSM825 '12-13			





### HUSQVARNA

**DIRT**  
APRILIA  
BETA  
BMW  
GAS GAS  
HONDA  
HUSABERG  
HUSQVARNA  
KAWASAKI  
KTM  
MOTO TM  
RIEJU  
SHERCO  
SUZUKI  
YAMAHA

FC 350  
4-Stroke  
Please Note:  
Nikasil Piston Size  
-Std. Compression 13.5:1  
-Forged Piston  
-Fuel Injection  
-KTM Engine

**Piston Kit**  
01.6353.A  
01.6353.B  
01.6353.C  
'14-15

**SIZES (mm)**  
87.96  
87.97  
87.98

**Ring Set**  
02.6351  
02.6351  
02.6351  
'14-15

**Crank Bearing & Seal Kit**  
23.CBS63013  
'14-15  
23.CBS63016  
'16-18  
23.CBS63017  
'19-23

**Con. Rod Kit**  
03.6363  
'14-15  
03.6366  
'16-23  
**Crankpin**  
06.3259.9-1  
'16-23

**Complete**  
34.6343  
'14-15  
34.6336  
'16-18  
**Top-End**  
35.6351  
'14-15  
35.6315  
'16-18  
35.6319  
'19-22

**Cam Chain**  
31.6351  
'14-15  
31.6356  
'16-22  
31.6363  
'23  
**Valve Shim Assortment**  
29.VSA890  
'14-23  
29.VSA890-2  
'14-23

**Valve**  
28.6351-1  
'14-22 2x Exhaust  
Titanium  
28.6351-2  
'14-22 2x Intake  
Titanium  
28.6353-1  
'23 2x Exhaust  
Titanium  
28.6353-2  
'23 2x Intake  
Titanium

**STREET**  
APRILIA  
CAGIVA  
HONDA  
KAWASAKI  
KTM  
SUZUKI  
YAMAHA

Please Note:  
Nikasil Piston Size  
-Std. Compression 14.6:1  
-Forged Piston  
-Fuel Injection  
-KTM Engine

**Piston Kit**  
01.6353.A  
01.6353.B  
01.6353.C  
'23

**SIZES (mm)**  
87.96  
87.97  
87.98

**Ring Set**  
02.6351  
02.6351  
02.6351  
'23

**Bearing**  
23.NJ206EPC-3  
'14-23 2x  
**Oilseal Set**  
42.6351  
'14-15  
42.6336  
'16-18  
**Oilseal**  
41.6-405561  
'19-23

**Head & Base**  
36.6314  
'14-15  
36.6326  
'16-18  
36.6319  
'19-22

**Valve Seal**  
35.VS029  
'14-23  
35.VS028  
'23 4x  
**Ignition Cover Gasket**  
19.G96351  
'15  
19.G96316  
'16-22

**TI-Steel Conversion Set**  
28.SES6351-1  
'14-15 Exhaust  
28.SIS6351-2  
'14-15 Intake

**ATV-UTV**  
CAN-AM  
GAS GAS  
HONDA  
KAWASAKI  
KTM  
POLARIS  
SUZUKI  
YAMAHA

Please Note:  
Nikasil Piston Size  
-High Compression 14.5:1  
-Forged Piston  
-Fuel Injection  
-KTM Engine

**High Compression Piston Kit**  
01.6352.A  
01.6352.B  
'14-15

**SIZES (mm)**  
87.96  
87.97

**Ring Set**  
02.6351  
02.6351  
'14-15

**Pin**  
04.1844.4  
'14-22  
**Clips**  
05.1812  
'14-22

**PWC**  
KAWASAKI  
POLARIS  
SEA DOO  
YAMAHA

**SNOW**  
ARCTIC CAT  
KAWASAKI  
LYNX  
MOTO-SKI  
POLARIS  
SKI DOO  
YAMAHA

**MOPED & SCOOTER**

**MISC. TECH. SPECIAL**

Footnotes: \* Bearings Only \*\* Rubbers included

**DIRT**  
APRILIA  
BETA  
BMW  
GAS GAS  
HONDA  
HUSABERG  
HUSQVARNA  
KAWASAKI  
KTM  
MOTO TM  
RIEJU  
SHERCO  
SUZUKI  
YAMAHA

**STREET**  
APRILIA  
CAGIVA  
HONDA  
KAWASAKI  
KAWASAKI  
KTM  
SUZUKI  
YAMAHA

**ATV-UTV**  
CAN-AM  
GAS GAS  
HONDA  
KAWASAKI  
KAWASAKI  
KTM  
POLARIS  
SUZUKI  
YAMAHA

**PWC**  
KAWASAKI  
POLARIS  
SEA DOO  
YAMAHA

**SNOW**  
ARCTIC CAT  
KAWASAKI  
LYNX  
MOTO-SKI  
POLARIS  
SKI DOO  
YAMAHA

**MOPED & SCOOTER**

**MISC. TECH. SPECIAL**

**Air Filter**  
52.62011  
'14-15  
52.62016  
'16-22  
52.62023  
'23  
**Throttle Cable**  
53.110045  
'14-15  
53.112060  
'16-18  
53.112073  
'19-22  
53.112090  
'23  
**Oil Filter**  
54.63652  
'14-23 1-Pce.  
54.63652-50  
'14-23 50-Pcs.

**Spring Kit**  
17.CS63051  
'14-15  
**Cover Gasket**  
19.G6351  
'14-15  
19.G6316  
'16-22  
**Master Cylinder Rebuild Kit**  
16.940000  
'14-15  
16.940011  
'16-18  
16.940012  
'19-20  
16.940011  
'21  
**Slave Cylinder Rebuild Kit**  
16.950001  
'14-15  
16.950015  
'16-21  
16.950014  
'22

**Complete Plate Set**  
16.CPS63011  
'14-15  
16.CPS63019  
'19-23  
**Friction Set**  
16.S53011  
'14-15  
16.S53016  
'16-23  
**Steel Set**  
16.S53029  
'14-15  
16.S53027  
'16-23

**F/W Bearing**  
23.S114002  
'14-23  
**R/W Bearing**  
23.S112073  
'14-22  
23.S160023  
'23  
**F/W Spacer Kit**  
26.710087  
'14  
26.710103  
'15-23  
**R/W Spacer Kit**  
26.710084  
'14-15  
26.710102  
'16-22  
**Steering Bearing**  
24.110026  
'14-22

**Frontbrake Disc**  
37.BD16290  
'14-23  
**Rearbrake Disc**  
37.BD26190  
'14-23  
**Front Pad Set**  
37.102202  
'14-23  
37.102202BX  
'14-23 Box of 10  
**Rear Pad Set**  
37.202302  
'14-23  
37.202302BX  
'14-23 Box of 10  
**Front Caliper Rebuild Kit**  
37.63046  
'14-23  
**Rear Caliper Rebuild Kit**  
37.63048  
'14-22

**Front Sprocket**  
07.FS62093-12  
07.FS62093-13  
07.FS62093-14  
07.FS62093-15  
'14-23  
**7075-T6 Alloy Rear Sprocket**  
07.RA62090-48  
07.RA62090-49  
07.RA62090-50  
07.RA62090-51  
07.RA62090-52  
'14-23  
**UltraLight Steel Rear Sprocket**  
07.RS62090R-48  
07.RS62090R-49  
07.RS62090R-50  
07.RS62090R-51  
07.RS62090R-52  
'14-23  
**Sprocket Bolt Set**  
07.SBSM825  
'14-23

**Chain**  
07.RC520120C  
'14-23 MX  
07.RC520120CG  
'14-23 MX Gold  
07.RC520120XC  
'14-23 X-Ring  
07.RC520120XCG  
'14-23 X-Ring Gold  
**Countershaft Seal Kit**  
26.640001  
'14-23

**Swingarm**  
26.210168  
'14-15  
26.210125  
'16-23  
**Linkage**  
26.110180  
'14-21  
**Lower**  
26.450066  
'14-21  
**Upper**  
26.450068  
'14-23

**Seal & Wiper**  
40.S4857.89  
'14  
**Oil Seal Set**  
40.F4857.89  
'14  
**Dust Seal Set**  
40.F4857.8D  
'14  
**Bushing Set**  
39.160082  
'14  
39.160122  
'15-16  
**Rear Shock Seal Head Kit**  
26.810127  
'14-20



### HUSQVARNA

**DIRT**  
APRILIA  
BETA  
BMW  
GAS GAS  
HONDA  
HUSABERG  
HUSQVARNA  
KAWASAKI  
KTM  
MOTO TM  
RIEJU  
SHERCO  
SUZUKI  
YAMAHA

FE 350 4-Stroke Please Note: Nikasil Piston Size -Std. Compression 12.3:1 -Forged Piston -Fuel Injection -KTM Engine	<b>Piston Kit</b> 01.6362.A 01.6362.B 01.6362.C '14-16	<b>Size</b> 87.96 87.97 87.98	<b>Ring Set</b> 02.6351 02.6351 02.6351 '14-16	<b>Crank Bearing &amp; Seal Kit</b> 23.CBS63013 '14-15 23.CBS63017 '16-23	<b>Con. Rod Kit</b> 03.6363 '14-16 03.6366 '17-23	<b>Complete</b> 34.6312 '14-16 34.6337 '17-19	<b>Cam Chain</b> 31.6351 '14-16 31.6356 '17-23	<b>Valve</b> 28.6351-1 '14-19 2x Exhaust Titanium 28.6351-2 '14-19 2x Intake Titanium 28.6362-1 '20-23 2x Exhaust Steel 28.6362-2 '20-23 2x Intake Steel
Please Note: Nikasil Piston Size -Std. Compression 12.3:1 -Forged Piston -Fuel Injection -KTM Engine	01.6367.A 01.6367.B 01.6367.C '17-19	87.96 87.97 87.98	02.6351 02.6351 02.6351 '17-19	<b>Bearing</b> 23.NJ206EPC-3 '14-23 2x	<b>Crankpin</b> 06.3259.9-1 '17-23	<b>Top-End</b> 35.6351 '14-16 35.6315 '17-19 35.6319 '20-23	<b>Valve Shim Assortment</b> 29.VSA890 '14-23 29.VSA890-2 '14-23	<b>Valve Seal</b> 35.VS029 '14-23 4x
Please Note: Nikasil Piston Size -Std. Compression 13.5:1 -Forged Piston -Fuel Injection -KTM Engine	01.6353.A 01.6353.B 01.6353.C '20-23	87.96 87.97 87.98	02.6351 02.6351 02.6351 '20-23	<b>Oilseal Set</b> 42.6351 '14-15		<b>Head &amp; Base</b> 36.6311 '14-16 36.6326 '16-19 36.6319 '20-23	<b>TI-Steel Conversion Set</b> 28.SES6353-1 '14-16 Exhaust 28.SIS6353-2 '14-16 Intake	
			<b>Pin</b> 04.1844.4 '14-23			<b>Ignition Cover Gasket</b> 19.G96314 '14-16 19.G96316 '17-23		
			<b>Clips</b> 05.1812 '14-23					

**STREET**  
APRILIA  
CAGIVA  
HONDA  
KAWASAKI  
KTM  
SUZUKI  
YAMAHA

**ATV-UTV**  
CAN-AM  
GAS GAS  
HONDA  
KAWASAKI  
KTM  
POLARIS  
SUZUKI  
YAMAHA

**PWC**  
KAWASAKI  
POLARIS  
SEA DOO  
YAMAHA

**SNOW**  
ARCTIC CAT  
KAWASAKI  
LYNX  
MOTO-SKI  
POLARIS  
SKI DOO  
YAMAHA

**MOPED & SCOOTER**

**MISC. TECH. SPECIAL**

Footnotes: \* Bearings Only \*\* Rubbers included

**DIRT**  
APRILIA  
BETA  
BMW  
GAS GAS  
HONDA  
HUSABERG  
HUSQVARNA  
KAWASAKI  
KTM  
MOTO TM  
RIEJU  
SHERCO  
SUZUKI  
YAMAHA

**STREET**  
APRILIA  
CAGIVA  
HONDA  
KAWASAKI  
KTM  
SUZUKI  
YAMAHA

**ATV-UTV**  
CAN-AM  
GAS GAS  
HONDA  
KAWASAKI  
KTM  
POLARIS  
SUZUKI  
YAMAHA

**PWC**  
KAWASAKI  
POLARIS  
SEA DOO  
YAMAHA

**SNOW**  
ARCTIC CAT  
KAWASAKI  
LYNX  
MOTO-SKI  
POLARIS  
SKI DOO  
YAMAHA

**MOPED & SCOOTER**

**MISC. TECH. SPECIAL**

<b>Air Filter</b> 52.62011 '14-16 52.62016 '17-23	<b>Cover Gasket</b> 19.G6351 '14-16 19.G6316 '17-23	<b>Complete Plate Set</b> 16.CPS64012 '14-23	<b>F/W Bearing</b> 23.S114002 '14-23	<b>Frontbrake Disc</b> 37.BD16290 '14-23	<b>Front Sprocket</b> 07.FS62093-12 07.FS62093-13 07.FS62093-14 07.FS62093-15 '14-23	<b>Chain</b> 07.RC520120C '14-23 MX 07.RC520120CG '14-23 MX Gold 07.RC520120XC '14-23 X-Ring 07.RC520120XCG '14-23 X-Ring Gold	<b>Swingarm</b> 26.210168 '14-16 26.210125 '17-23	<b>Seal &amp; Wiper</b> 40.S4857.89 '14
<b>Throttle Cable</b> 53.110045 '14-16 53.112060 '17-19 53.112072 '20-23	<b>Master Cylinder Rebuild Kit</b> 16.940000 '14-16 16.940012 '17-21	<b>Friction Set</b> 16.S53011 '14-23	<b>R/W Bearing</b> 23.S112073 '14-23	<b>Rearbrake Disc</b> 37.BD26190 '14-23	<b>7075-T6 Alloy Rear Sprocket</b> 07.RA62090-48 07.RA62090-49 07.RA62090-50 07.RA62090-51 07.RA62090-52 '14-23	<b>Countershaft Seal Kit</b> 26.640001 '14-23	<b>Linkage</b> 26.110180 '14-23	<b>Oil Seal Set</b> 40.F4857.89 '14
<b>Oil Filter</b> 54.63652 '14-23 1-Pce. 54.63652-50 '14-23 50-Pcs.	<b>Slave Cylinder Rebuild Kit</b> 16.950001 '14-16 16.950015 '17-21	<b>Steel Set</b> 16.S53029 '14-23	<b>F/W Spacer Kit</b> 26.710087 '14-15 26.710103 '16-23	<b>Front Pad Set</b> 37.102202 '14-23 37.102202BX '14-23 Box of 10	<b>7075-T6 Alloy Rear Sprocket</b> 07.RA62090-48 07.RA62090-49 07.RA62090-50 07.RA62090-51 07.RA62090-52 '14-23	<b>Lower</b> 26.450066 '14-23	<b>Dust Seal Set</b> 40.F4857.8D '14	<b>Upper</b> 26.450068 '14-23
<b>Water Pump Rebuild Kit</b> 57.6321 '14-16 57.6327 '17			<b>R/W Spacer Kit</b> 26.710084 '14-23	<b>Rear Pad Set</b> 37.202302 '14-23 37.202302BX '14-23 Box of 10	<b>UltraLight Steel Rear Sprocket</b> 07.RS62090R-48 07.RS62090R-49 07.RS62090R-50 07.RS62090R-51 07.RS62090R-52 '14-23	<b>Bushing Set</b> 39.160082 '14	<b>Rear Shock Seal Head Kit</b> 26.810127 '14-20	<b>Rear Shock Seal Head Kit</b> 26.810127 '14-20
			<b>Steering Bearing</b> 24.110026 '14-23	<b>Front Caliper Rebuild Kit</b> 37.63046 '14-17	<b>Sprocket Bolt Set</b> 07.SBSM825 '14-23			
				<b>Rear Caliper Rebuild Kit</b> 37.63048 '14-16 37.RBPK001 '14-16 37.RBPK003 '17				
				<b>Front Master Cylinder Rebuild Kit</b> 37.910035 '14-17				
				<b>Rear Master Cylinder Rebuild Kit</b> 37.910030 '14-17				
				<b>Brake Pedal Rebuild Kit</b> 37.RBPK001 '14-16 37.RBPK003 '17				

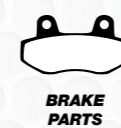

### HUSQVARNA

**DIRT**  
APRILIA  
BETA  
BMW  
GAS GAS  
HONDA  
HUSABERG  
HUSQVARNA  
KAWASAKI  
KTM  
MOTO TM  
RIEJU  
SHERCO  
SUZUKI  
YAMAHA

**STREET**  
APRILIA  
CAGIVA  
HONDA  
KAWASAKI  
KTM  
SUZUKI  
YAMAHA

**ATV-UTV**  
CAN-AM  
GAS GAS  
HONDA  
KAWASAKI  
KTM  
POLARIS  
SUZUKI  
YAMAHA

**PWC**  
KAWASAKI  
POLARIS  
SEA DOO  
YAMAHA

**SNOW**  
ARCTIC CAT  
KAWASAKI  
LYNX  
MOTO-SKI  
POLARIS  
SKI DOO  
YAMAHA

**MOPED & SCOOTER**

**MISC. TECH. SPECIAL**

Model	Piston Kit	Size	Ring Set	Con. Rod Kit
SMR 400 4-Stroke	-	-	-	03.6425 '05-07
TC 410 4-Stroke Please Note: Nikasil Piston Size -Forged Piston	01.6409.A 01.6409.B 01.6409.C '99-01	91.44 91.45 91.46	02.6409 02.6409 02.6409 '99-01  Clips 05.2012 '99-01	
TC 449 4-Stroke Please Note: Nikasil Piston Size -Std. Compression 13.0:1 -Forged Piston -Fuel Injection	01.6411.A 01.6411.B 01.6411.C '11-13	97.95 97.96 97.97	02.6601 02.6601 02.6601 '11-13  Clips 05.2012 '11-13	

Footnotes: \* Bearings Only \*\* Rubbers included

Model	F/W Bearing	R/W Bearing	Steering Bearing	Front Sprocket	Rear Sprocket	Chain	Upper
	23.S114017 '99 23.S114013 '00-01	23.S114018 '99 23.S114020 '00-01	24.110032 '99-01	07.FS63000-12 07.FS63000-13 07.FS63000-14 07.FS63000-15 '99-01	07.RC520120C '05-07 MX 07.RC520120CG '05-07 MX Gold 07.RC520120XC '05-07 X-Ring 07.RC520120XCG '05-07 X-Ring Gold	26.350080 '04	
				07.RA62097-46 07.RA62097-47 07.RA62097-48 07.RA62097-49 07.RA62097-50 07.RA62097-51 07.RA62097-52 '99-01	07.RC520120C '99-01 MX 07.RC520120CG '99-01 MX Gold 07.RC520120XC '99-01 X-Ring 07.RC520120XCG '99-01 X-Ring Gold		
				07.RS62097R-46 07.RS62097R-47 07.RS62097R-48 07.RS62097R-49 07.RS62097R-50 07.RS62097R-51 07.RS62097R-52 '99-01	07.RC520120C '11-13 MX 07.RC520120CG '11-13 MX Gold 07.RC520120XC '11-13 X-Ring 07.RC520120XCG '11-13 X-Ring Gold		
				07.FS64011-13 07.FS64011-14 07.FS64011-15 '11-13	07.RA62097-46 07.RA62097-47 07.RA62097-48 07.RA62097-49 07.RA62097-50 07.RA62097-51 07.RA62097-52 '11-13	07.RC520120C '11-13 MX 07.RC520120CG '11-13 MX Gold 07.RC520120XC '11-13 X-Ring 07.RC520120XCG '11-13 X-Ring Gold	40.S485810 '11-13
				07.RS62097R-46 07.RS62097R-47 07.RS62097R-48 07.RS62097R-49 07.RS62097R-50 07.RS62097R-51 07.RS62097R-52 '11-13	07.RC520120C '11-13 MX 07.RC520120CG '11-13 MX Gold 07.RC520120XC '11-13 X-Ring 07.RC520120XCG '11-13 X-Ring Gold	40.F485810 '11-13	
				07.RA62097-46 07.RA62097-47 07.RA62097-48 07.RA62097-49 07.RA62097-50 07.RA62097-51 07.RA62097-52 '11-13	07.RC520120C '11-13 MX 07.RC520120CG '11-13 MX Gold 07.RC520120XC '11-13 X-Ring 07.RC520120XCG '11-13 X-Ring Gold	40.F4858D '11-13	
				07.RS62097R-46 07.RS62097R-47 07.RS62097R-48 07.RS62097R-49 07.RS62097R-50 07.RS62097R-51 07.RS62097R-52 '11-13	07.RC520120C '11-13 MX 07.RC520120CG '11-13 MX Gold 07.RC520120XC '11-13 X-Ring 07.RC520120XCG '11-13 X-Ring Gold	39.160068 '11-13	

**DIRT**  
APRILIA  
BETA  
BMW  
GAS GAS  
HONDA  
HUSABERG  
HUSQVARNA  
KAWASAKI  
KTM  
MOTO TM  
RIEJU  
SHERCO  
SUZUKI  
YAMAHA

**STREET**  
APRILIA  
CAGIVA  
HONDA  
KAWASAKI  
KTM  
SUZUKI  
YAMAHA

**ATV-UTV**  
CAN-AM  
GAS GAS  
HONDA  
KAWASAKI  
KTM  
POLARIS  
SUZUKI  
YAMAHA

**PWC**  
KAWASAKI  
POLARIS  
SEA DOO  
YAMAHA

**SNOW**  
ARCTIC CAT  
KAWASAKI  
LYNX  
MOTO-SKI  
POLARIS  
SKI DOO  
YAMAHA

**MOPED & SCOOTER**

**MISC. TECH. SPECIAL**



PISTON KITS



SIZES (mm)



PISTON PARTS



CRANKSHAFT PARTS



CONNECTING ROD PARTS



GASKETS



VALVE TRAIN PARTS I



VALVE TRAIN PARTS II



AIR & FUEL PARTS



CLUTCH PARTS



CLUTCH PLATE SETS



WHEEL & STEERING PARTS



BRAKE PARTS



DRIVE CHAIN PARTS I



DRIVE CHAIN PARTS II



SUSPENSION BEARING KITS



SUSPENSION PARTS



HUSQVARNA

DIRT  
APRILIA  
BETA  
BMW  
GAS GAS  
HONDA  
HUSABERG  
HUSQVARNA  
KAWASAKI  
KTM  
MOTO TM  
RIEJU  
SHERCO  
SUZUKI  
YAMAHA

STREET  
APRILIA  
CAGIVA  
HONDA  
KAWASAKI  
KTM  
SUZUKI  
YAMAHA

ATV-UTV  
CAN-AM  
GAS GAS  
HONDA  
KAWASAKI  
KTM  
POLARIS  
SUZUKI  
YAMAHA

PWC  
KAWASAKI  
POLARIS  
SEA DOO  
YAMAHA

SNOW  
ARCTIC CAT  
KAWASAKI  
LYNX  
MOTO-SKI  
POLARIS  
SKI DOO  
YAMAHA

MOPED & SCOOTER

MISC. TECH. SPECIAL

TE / TXC 449 SMR 449 4-Stroke Please Note: Nikasil Piston Size -Std. Compression 12.0:1 -Forged Piston -Fuel Injection	<b>Piston Kit</b> 01.6411.A 01.6411.B 01.6411.C '11-13 TE/TXC '11 SMR	<b>Size</b> 97.95 97.96 97.97	<b>Ring Set</b> 02.6601 02.6601 02.6601 '11-13 TE/TXC '11 SMR  <b>Clips</b> 05.2012 '11-13						
TC 450 4-Stroke Please Note: Nikasil Piston Size -Std. Compression 12.9:1 -Forged Piston	<b>Piston Kit</b> 01.6438.A 01.6438.B 01.6438.C '06-10	<b>Size</b> 96.96 96.97 96.98	<b>Ring Set</b> 02.2440 02.2440 02.2440 '06-10  <b>Pin</b> 04.2045 '06-10  <b>Clips</b> 05.2012 '06-10	<b>Con. Rod Kit</b> 03.6425 '06-10  <b>Crankpin</b> 06.3458.3 '06-10	<b>Valve Shim Assortment</b> 29.VSA948 '06-10 29.VSA948-2 '06-10	<b>Valve</b> 28.6425-1 '05 2x Exhaust Titanium 28.6425-2 '05 2x Intake Titanium			

Footnotes: \* Bearings Only \*\* Rubbers included

DIRT  
APRILIA  
BETA  
BMW  
GAS GAS  
HONDA  
HUSABERG  
HUSQVARNA  
KAWASAKI  
KTM  
MOTO TM  
RIEJU  
SHERCO  
SUZUKI  
YAMAHA

STREET  
APRILIA  
CAGIVA  
HONDA  
KAWASAKI  
KTM  
SUZUKI  
YAMAHA

ATV-UTV  
CAN-AM  
GAS GAS  
HONDA  
KAWASAKI  
KTM  
POLARIS  
SUZUKI  
YAMAHA

PWC  
KAWASAKI  
POLARIS  
SEA DOO  
YAMAHA

SNOW  
ARCTIC CAT  
KAWASAKI  
LYNX  
MOTO-SKI  
POLARIS  
SKI DOO  
YAMAHA

MOPED & SCOOTER

MISC. TECH. SPECIAL

<b>Air Filter</b> 52.64012 '12-13		<b>F/W Bearing</b> 23.S114015 '11 23.S116061 '12-13  <b>R/W Bearing</b> 23.S114020 '11-13  <b>Steering Bearing</b> 24.110061 '11-13	<b>Frontbrake Disc</b> 37.BD16200 '11-13 TE/TXC  <b>Rearbrake Disc</b> 37.BD26211 '11-13 TE/TXC  <b>Front Pad Set</b> 37.102202 '11-13 NOT SMR 37.102202BX '11-13 Box of 10  <b>Rear Pad Set</b> 37.202302 '11-13 37.202302BX '11-13 Box of 10	<b>Front Sprocket</b> 07.FS64011-13 07.FS64011-14 07.FS64011-15 '11-13  <b>7075-T6 Alloy Rear Sprocket</b> 07.RA62097-46 07.RA62097-47 07.RA62097-48 07.RA62097-49 07.RA62097-50 07.RA62097-51 07.RA62097-52 '11-13  <b>UltraLight Steel Rear Sprocket</b> 07.RS62097R-46 07.RS62097R-47 07.RS62097R-48 07.RS62097R-49 07.RS62097R-50 07.RS62097R-51 07.RS62097R-52 '11-13  <b>Sprocket Bolt Set</b> 07.SBSM825 '11-13	<b>Chain</b> 07.RC520120C '11-13 MX 07.RC520120CG '11-13 MX Gold 07.RC520120XC '11-13 X-Ring 07.RC520120XCG '11-13 X-Ring Gold  <b>Upper Chain Roller</b> 33.0001 '11-13	<b>Seal &amp; Wiper</b> 40.S485810 '11-13  <b>Oil Seal Set</b> 40.F485810 '11-13  <b>Dust Seal Set</b> 40.F4858D '11-13  <b>Bushing Set</b> 39.160068 '11-13
<b>Air Filter</b> 52.63092 '02-10  <b>Main Jet</b> 45.100-225 '05-10 Keihin  <b>Pilot Jet</b> 46.040-085 '05-10 Keihin  <b>Carburetor Rebuild Kit</b> 55.10521 '05-10  <b>Throttle Cable</b> 53.112015 '03-04 53.110053 '05-10  <b>Oil Filter</b> 54.63154 '02-07 1-Pce. 54.63154-50 '02-07 50-Pcs. 54.63563 '08-10 1-Pce. 54.63563-50 '08-10 50-Pcs.	<b>Friction Set</b> 16.S14015 '08-10  <b>Steel Set</b> 16.S14016 '08-10	<b>F/W Bearing</b> 23.S114015 '03-10  <b>R/W Bearing</b> 23.S114020 '03-10  <b>Steering Bearing</b> 24.110061 '03-10	<b>Frontbrake Disc</b> 37.BD16200 '03-10  <b>Front Pad Set</b> 37.102202 '02-10 37.102202BX '02-10 Box of 10  <b>Rear Pad Set</b> 37.202302 '05-10 37.202302BX '05-10 Box of 10	<b>Front Sprocket</b> 07.FS63000-12 07.FS63000-13 07.FS63000-14 07.FS63000-15 '02-10  <b>7075-T6 Alloy Rear Sprocket</b> 07.RA62097-46 07.RA62097-47 07.RA62097-48 07.RA62097-49 07.RA62097-50 07.RA62097-51 07.RA62097-52 '02-10  <b>UltraLight Steel Rear Sprocket</b> 07.RS62097R-46 07.RS62097R-47 07.RS62097R-48 07.RS62097R-49 07.RS62097R-50 07.RS62097R-51 07.RS62097R-52 '02-10  <b>Sprocket Bolt Set</b> 07.SBSM825 '02-10	<b>Chain</b> 07.RC520120C '02-10 MX 07.RC520120CG '02-10 MX Gold 07.RC520120XC '02-10 X-Ring 07.RC520120XCG '02-10 X-Ring Gold  <b>Lower Chain Roller</b> 33.0001 '03-10  <b>Upper Chain Roller</b> 33.0001 '03-10	<b>Swingarm</b> 26.210119 '03-07 26.210199 '08-10  <b>Linkage</b> 26.110147 '05-07 26.110176 '08-10  <b>Upper Bushing Set</b> 26.350080 '03-04  <b>Lower Bushing Set</b> 26.450044 '03-07 26.450062 '08-10  <b>Rear Shock Seal Head Kit</b> 26.810124 '03-04

DIRT  
APRILIA  
BETA  
BMW  
GAS GAS  
HONDA  
HUSABERG  
HUSQVARNA  
KAWASAKI  
KTM  
MOTO TM  
RIEJU  
SHERCO  
SUZUKI  
YAMAHA

STREET  
APRILIA  
CAGIVA  
HONDA  
KAWASAKI  
KTM  
SUZUKI  
YAMAHA

ATV-UTV  
CAN-AM  
GAS GAS  
HONDA  
KAWASAKI  
KTM  
POLARIS  
SUZUKI  
YAMAHA

PWC  
KAWASAKI  
POLARIS  
SEA DOO  
YAMAHA

SNOW  
ARCTIC CAT  
KAWASAKI  
LYNX  
MOTO-SKI  
POLARIS  
SKI DOO  
YAMAHA

MOPED & SCOOTER

MISC. TECH. SPECIAL



**HUSQVARNA****DIRT**  
APRILIA  
BETA  
BMW  
GAS GAS  
HONDA  
HUSABERG  
HUSQVARNA  
KAWASAKI  
KTM  
MOTO TM  
RIEJU  
SHERCO  
SUZUKI  
YAMAHA

TE 450 4-Stroke Please Note: Nikasil Piston Size -Std. Compression 12.9:1 -Forged Piston	<b>Piston Kit</b> 01.6436.A 01.6436.B 01.6436.C '06-10	<b>Size</b> 96.96 96.97 96.98	<b>Ring Set</b> 02.2440 02.2440 02.2440 '06-10  <b>Pin</b> 04.2047.6 '06-10  <b>Clips</b> 05.2012 '06-10		<b>Con. Rod Kit</b> 03.6425 '06-10  <b>Crankpin</b> 06.3458.3 '06-10		<b>Valve Shim Assortment</b> 29.VSA948 '06-10 29.VSA948-2 '06-10	<b>Valve</b> 28.6425-1 '05 2x Exhaust Titanium 28.6425-2 '05 2x Intake Titanium
---	--	--	--	--	--	--	--	---

**STREET**  
APRILIA  
CAGIVA  
HONDA  
KAWASAKI  
KTM  
SUZUKI  
YAMAHA

TXC 450 4-Stroke Please Note: Nikasil Piston Size -Std. Compression 12.9:1 -Forged Piston	<b>Piston Kit</b> 01.6438.A 01.6438.B 01.6438.C '08-10	<b>Size</b> 96.96 96.97 96.98	<b>Ring Set</b> 02.2440 02.2440 02.2440 '08-10  <b>Pin</b> 04.2045 '08-10  <b>Clips</b> 05.2012 '08-10		<b>Con. Rod Kit</b> 03.6425 '08-10  <b>Crankpin</b> 06.3458.3 '08-10		<b>Valve Shim Assortment</b> 29.VSA948 '08-10 29.VSA948-2 '08-10	
--	--	--	--	--	--	--	--	--

**PWC**  
KAWASAKI  
POLARIS  
SEA DOO  
YAMAHA**SNOW**  
ARCTIC CAT  
KAWASAKI  
LYNX  
MOTO-SKI  
POLARIS  
SKI DOO  
YAMAHA**MOPED & SCOOTER****MISC. TECH. SPECIAL**

Footnotes: \* Bearings Only \*\* Rubbers included

<b>Air Filter</b> 52.63092 '02-10		<b>Friction Set</b> 16.S14015 '08-10	<b>F/W Bearing</b> 23.S114015 '03-10	<b>Frontbrake Disc</b> 37.BD16200 '03-10	<b>Front Sprocket</b> 07.FS63000-12 07.FS63000-13 07.FS63000-14 07.FS63000-15 '03-10	<b>Chain</b> 07.RC520120C '03-10 MX 07.RC520120CG '03-10 MX Gold 07.RC520120XC '03-10 X-Ring 07.RC520120XCG '03-10 X-Ring Gold	<b>Swingarm</b> 26.210119 '03-07 26.210199 '08-10	<b>Seal &amp; Wiper</b> 40.S485810 '10	
<b>Main Jet</b> 45.100-225 '05-07 Keihin		<b>Steel Set</b> 16.S14016 '08-10	<b>R/W Bearing</b> 23.S114020 '03-10	<b>Front Pad Set</b> 37.102202 '02-10 37.102202BX '02-10 Box of 10	<b>7075-T6 Alloy Rear Sprocket</b> 07.RA62097-46 07.RA62097-47 07.RA62097-48 07.RA62097-49 07.RA62097-50 07.RA62097-51 07.RA62097-52 '04-10	<b>Lower Chain Roller</b> 33.0001 '03-10	<b>Linkage</b> 26.110147 '05-07 26.110176 '08-10	<b>Oil Seal Set</b> 40.F485810 '10	
<b>Pilot Jet</b> 46.040-085 '05-07 Keihin			<b>Steering Bearing</b> 24.110032 '03-07 24.110061 '08-13	<b>Rear Pad Set</b> 37.202302 '06-10 37.202302BX '06-10 Box of 10	<b>Upper Chain Roller</b> 33.0001 '03-10	<b>Upper</b> 26.350080 '03-07	<b>Dust Seal Set</b> 40.F4858D '10	<b>Bushing Set</b> 39.160068 '10-13	
<b>Carburetor Rebuild Kit</b> 55.10521 '05-09					<b>Sprocket Bolt Set</b> 07.SBSM825 '04-10	<b>Lower</b> 26.450044 '03-07 26.450062 '08-10	<b>Rear Shock Seal Head Kit</b> 26.810124 '03-04		
<b>Throttle Cable</b> 53.112015 '03-04 53.110053 '05-07 53.112020 '08-10									
<b>Oil Filter</b> 54.63154 '02-07 1-Pce. 54.63154-50 '02-07 50-Pcs. 54.63563 '08-10 1-Pce. 54.63563-50 '08-10 50-Pcs.									
<b>Air Filter</b> 52.63092 '08-10		<b>Friction Set</b> 16.S14015 '08-10	<b>F/W Bearing</b> 23.S114015 '08-10	<b>Frontbrake Disc</b> 37.BD16200 '08-10	<b>Front Sprocket</b> 07.FS63000-12 07.FS63000-13 07.FS63000-14 07.FS63000-15 '08-10	<b>Chain</b> 07.RC520120C '08-10 MX 07.RC520120CG '08-10 MX Gold 07.RC520120XC '08-10 X-Ring 07.RC520120XCG '08-10 X-Ring Gold	<b>Swingarm</b> 26.210199 '08-10	<b>Seal &amp; Wiper</b> 40.S485810 '10	
<b>Main Jet</b> 45.100-225 '08-10 Keihin		<b>Steel Set</b> 16.S14016 '08-10	<b>R/W Bearing</b> 23.S114020 '08-10	<b>Front Pad Set</b> 37.102202 '08-10 37.102202BX '08-10 Box of 10	<b>7075-T6 Alloy Rear Sprocket</b> 07.RA62097-46 07.RA62097-47 07.RA62097-48 07.RA62097-49 07.RA62097-50 07.RA62097-51 07.RA62097-52 '08-10	<b>Lower Chain Roller</b> 33.0001 '08-10	<b>Linkage</b> 26.110176 '08-10	<b>Oil Seal Set</b> 40.F485810 '10	
<b>Pilot Jet</b> 46.040-085 '08-10 Keihin			<b>Steering Bearing</b> 24.110061 '08-10	<b>Rear Pad Set</b> 37.202302 '08-10 37.202302BX '08-10 Box of 10	<b>Upper Chain Roller</b> 33.0001 '08-10	<b>Lower</b> 26.450062 '08-10	<b>Dust Seal Set</b> 40.F4858D '10	<b>Bushing Set</b> 39.160068 '10	
<b>Carburetor Rebuild Kit</b> 55.10521 '08-10					<b>Ultralight Steel Rear Sprocket</b> 07.RS62097R-46 07.RS62097R-47 07.RS62097R-48 07.RS62097R-49 07.RS62097R-50 07.RS62097R-51 07.RS62097R-52 '08-10				
<b>Throttle Cable</b> 53.110053 '08-10									
<b>Oil Filter</b> 54.63563 '08-10 1-Pce. 54.63563-50 '08-10 50-Pcs.									
					<b>Sprocket Bolt Set</b> 07.SBSM825 '08-10				

**DIRT**  
APRILIA  
BETA  
BMW  
GAS GAS  
HONDA  
HUSABERG  
HUSQVARNA  
KAWASAKI  
KTM  
MOTO TM  
RIEJU  
SHERCO  
SUZUKI  
YAMAHA**STREET**  
APRILIA  
CAGIVA  
HONDA  
KAWASAKI  
KTM  
SUZUKI  
YAMAHA**ATV-UTV**  
CAN-AM  
GAS GAS  
HONDA  
KAWASAKI  
KTM  
POLARIS  
SUZUKI  
YAMAHA**PWC**  
KAWASAKI  
POLARIS  
SEA DOO  
YAMAHA**SNOW**  
ARCTIC CAT  
KAWASAKI  
LYNX  
MOTO-SKI  
POLARIS  
SKI DOO  
YAMAHA**MOPED & SCOOTER****MISC. TECH. SPECIAL**



HUSQVARNA

DIRT  
APRILIA  
BETA  
BMW  
GAS GAS  
HONDA  
HUSABERG  
HUSQVARNA  
KAWASAKI  
KTM  
MOTO TM  
RIEJU  
SHERCO  
SUZUKI  
YAMAHA

SMR 450 4-Stroke Please Note: Nikasil Piston Size -Std. Compression 12.9:1 -Forged Piston	<b>Piston Kit</b> 01.6436.A 01.6436.B 01.6436.C '06-10	<b>Size</b> 96.96 96.97 96.98	<b>Ring Set</b> 02.2440 02.2440 02.2440 '06-10  <b>Pin</b> 04.2047.6 '06-10  <b>Clips</b> 05.2012 '06-10		<b>Con. Rod Kit</b> 03.6425 '06-10  <b>Crankpin</b> 06.3458.3 '06-10		<b>Valve Shim Assortment</b> 29.VSA948 '06-10 29.VSA948-2 '06-10	
--	--	--	--	--	--	--	--	--

STREET  
APRILIA  
CAGIVA  
HONDA  
KAWASAKI  
KTM  
SUZUKI  
YAMAHA

FC 450 4-Stroke Please Note: Nikasil Piston Size -Std. Compression 12.6:1 -Forged Piston -Fuel Injection -KTM Engine	<b>Piston Kit</b> 01.6433.A 01.6433.B 01.6433.C '14-22	<b>Size</b> 94.95 94.96 94.97	<b>Ring Set</b> 02.6429 02.6429 02.6429 '14-22	<b>Crank Bearing &amp; Seal Kit</b> 23.CBS64012 '14-15 23.CBS64016 '16-23  <b>Bearing</b> 23.SX07E39 '14-15 2x 23.NJ207ECP-1 '16-23 2x	<b>Con. Rod Kit</b> 03.6433 '14-15 03.6436 '16-23  <b>Crankpin</b> 06.3562 '16-23	<b>Complete</b> 34.6414 '14-15 34.6416 '16-17 31.1335 '19-22 31.6443 '23	<b>Cam Chain</b> 31.6428 '14-15 31.6328 '16-18 31.1335 '19-22 31.6443 '23	<b>Valve</b> 28.6433-1 '14-18 2x Exhaust Titanium 28.6433-2 '14-18 2x Intake Titanium 28.6419-1 '19-23 2x Exhaust Titanium 28.6419-2 '19-23 2x Intake Titanium
---	--	--	--	--	---	--	---	--

PWC  
KAWASAKI  
POLARIS  
SEA DOO  
YAMAHA

Please Note: Nikasil Piston Size -Std. Compression 13.1:1 -Forged Piston -Fuel Injection -KTM Engine	01.6443.A 01.6443.B 01.6443.C '23	94.96 94.97 94.98	TBA TBA TBA '23  <b>Clips</b> 05.1912 '14-22		<b>Oilseal Set</b> 42.6432 '14-15	<b>Head &amp; Base</b> 36.6414 '14-15 36.6416 '16-23	<b>Valve Shim Assortment</b> 29.VSA890 '14-23 29.VSA890-2 '14-23	<b>Valve Seal</b> 35.VS026 '14-23 4x
---	--	-------------------------	---	--	---	--	--	--

SNOW  
ARCTIC CAT  
KAWASAKI  
LYNX  
MOTO-SKI  
POLARIS  
SKI DOO  
YAMAHA

						<b>Ignition Cover Gasket</b> 19.G96433 '14-15 19.G96416 '16-22		
--	--	--	--	--	--	--	--	--

MOPED & SCOOTER

--	--	--	--	--	--	--	--	--

MISC. TECH. SPECIAL

Footnotes: \* Bearings Only \*\* Rubbers included

DIRT  
APRILIA  
BETA  
BMW  
GAS GAS  
HONDA  
HUSABERG  
HUSQVARNA  
KAWASAKI  
KTM  
MOTO TM  
RIEJU  
SHERCO  
SUZUKI  
YAMAHA

STREET  
APRILIA  
CAGIVA  
HONDA  
KAWASAKI  
KTM  
SUZUKI  
YAMAHA

ATV-UTV  
CAN-AM  
GAS GAS  
HONDA  
KAWASAKI  
KTM  
POLARIS  
SUZUKI  
YAMAHA

PWC  
KAWASAKI  
POLARIS  
SEA DOO  
YAMAHA

SNOW  
ARCTIC CAT  
KAWASAKI  
LYNX  
MOTO-SKI  
POLARIS  
SKI DOO  
YAMAHA

MOPED & SCOOTER

MISC. TECH. SPECIAL

<b>Air Filter</b> 52.63092 '06-10  <b>Main Jet</b> 45.100-225 '05-07 Keihin  <b>Pilot Jet</b> 46.040-085 '05-07 Keihin  <b>Throttle Cable</b> 53.110053 '05-07 53.112020 '08-10  <b>Carburetor Rebuild Kit</b> 55.10521 '05-09  <b>Oil Filter</b> 54.63154 '04-07 1-Pce. 54.63154-50 '04-07 50-Pcs. 54.63563 '08-10 1-Pce. 54.63563-50 '08-10 50-Pcs.		<b>Friction Set</b> 16.S14015 '08-10  <b>Steel Set</b> 16.S14016 '08-10	<b>F/W Bearing</b> 23.S114015 '05-10  <b>R/W Bearing</b> 23.S114020 '05-10  <b>Steering Bearing</b> 24.110032 '03-07 24.110061 '08-10		<b>Front Sprocket</b> 07.FS63000-12 07.FS63000-13 07.FS63000-14 07.FS63000-15 '03-10  <b>7075-T6 Alloy Rear Sprocket</b> 07.RA62097-46 07.RA62097-47 07.RA62097-48 07.RA62097-49 07.RA62097-50 07.RA62097-51 07.RA62097-52 '06-10  <b>Ultralight Steel Rear Sprocket</b> 07.RS62097R-46 07.RS62097R-47 07.RS62097R-48 07.RS62097R-49 07.RS62097R-50 07.RS62097R-51 07.RS62097R-52 '06-10  <b>Sprocket Bolt Set</b> 07.SBSM825 '06-10	<b>Chain</b> 07.RC520120C '05-10 MX 07.RC520120CG '05-10 MX Gold 07.RC520120XC '05-10 X-Ring 07.RC520120XCG '05-10 X-Ring Gold  <b>Lower Chain Roller</b> 33.0001 '03-10  <b>Upper Chain Roller</b> 33.0001 '03-10	<b>Swingarm</b> 26.210119 '03-07 26.210199 '08-10  <b>Linkage</b> 26.110147 '05-07 26.110176 '08-10  <b>Upper</b> 26.350080 '03-07  <b>Lower</b> 26.450044 '03-07 26.450062 '08-10	<b>Bushing Set</b> 39.160068 '10  <b>Rear Shock Seal Head Kit</b> 26.810124 '03-04
---	--	---	---	--	---	--	--	--

<b>Air Filter</b> 52.62011 '14-15 52.62016 '16-22 52.62023 '23  <b>Throttle Cable</b> 53.110045 '14-15 53.112060 '16-18 53.112073 '19-22 53.112090 '23  <b>Oil Filter</b> 54.63655 '14-15 1-Pce. 54.63655-50 '14-15 50-Pcs. 54.63652 '16-23 1-Pce. 54.63652-50 '16-23 50-Pcs.	<b>Cover Gasket</b> 19.G6414 '14-22  <b>Master Cylinder Rebuild Kit</b> 16.940000 '14-15 16.940000 '22  <b>Slave Cylinder Rebuild Kit</b> 16.950003 '14-15 16.950012 '16-21	<b>Complete Plate Set</b> 16.CPS64012 '14-23  <b>Friction Set</b> 16.S53011 '14-23  <b>Steel Set</b> 16.S53029 '14-23	<b>F/W Bearing</b> 23.S114002 '14-23  <b>R/W Bearing</b> 23.S112073 '14-22 23.S160023 '23  <b>F/W Spacer Kit</b> 26.710087 '14 26.710103 '15-23  <b>R/W Spacer Kit</b> 26.710084 '14-15 26.710102 '16-22  <b>Steering Bearing</b> 24.110026 '14-22	<b>Frontbrake Disc</b> 37.BD16290 '14-23  <b>Rearbrake Disc</b> 37.BD26190 '14-23  <b>Front Pad Set</b> 37.102202 '14-23 37.102202BX '14-23 Box of 10  <b>Rear Pad Set</b> 37.202302 '14-23 37.202302BX '14-23 Box of 10  <b>Front Caliper Rebuild Kit</b> 37.63046 '14-23  <b>Rear Caliper Rebuild Kit</b> 37.63048 '14-22  <b>Front Master Cylinder Rebuild Kit</b> 37.910035 '14-23  <b>Rear Master Cylinder Rebuild Kit</b> 37.910030 '14-23  <b>Brake Pedal Rebuild Kit</b> 37.RBPK001 '14-15 37.RBPK003 '16-17	<b>Front Sprocket</b> 07.FS62093-12 07.FS62093-13 07.FS62093-14 07.FS62093-15 '14-23  <b>7075-T6 Alloy Rear Sprocket</b> 07.RA62090-48 07.RA62090-49 07.RA62090-50 07.RA62090-51 07.RA62090-52 '14-23  <b>Ultralight Steel Rear Sprocket</b> 07.RS62090R-48 07.RS62090R-49 07.RS62090R-50 07.RS62090R-51 07.RS62090R-52 '14-23  <b>Sprocket Bolt Set</b> 07.SBSM825 '14-23	<b>Chain</b> 07.RC520120C '14-23 MX 07.RC520120CG '14-23 MX Gold 07.RC520120XC '14-23 X-Ring 07.RC520120XCG '14-23 X-Ring Gold  <b>Countershaft Seal Kit</b> 26.640001 '14-23	<b>Swingarm</b> 26.210125 '14-23  <b>Linkage</b> 26.110180 '14-21  <b>Lower</b> 26.450066 '14-21  <b>Upper</b> 26.450068 '14-23	<b>Seal &amp; Wiper</b> 40.S4857.89 '14  <b>Oil Seal Set</b> 40.F4857.89 '14  <b>Dust Seal Set</b> 40.F4857.8D '14  <b>Bushing Set</b> 39.160082 '14 39.160122 '15-16 39.160128 '17  <b>Rear Shock Seal Head Kit</b> 26.810127 '14-20
---	---	---	--	--	---	---	---	---

--	--	--	--	--	--	--	--	--

--	--	--	--	--	--	--	--	--

DIRT  
APRILIA  
BETA  
BMW  
GAS GAS  
HONDA  
HUSABERG  
HUSQVARNA  
KAWASAKI  
KTM  
MOTO TM  
RIEJU  
SHERCO  
SUZUKI  
YAMAHA

STREET  
APRILIA  
CAGIVA  
HONDA  
KAWASAKI  
KTM  
SUZUKI  
YAMAHA

ATV-UTV  
CAN-AM  
GAS GAS  
HONDA  
KAWASAKI  
KTM  
POLARIS  
SUZUKI  
YAMAHA

PWC  
KAWASAKI  
POLARIS  
SEA DOO  
YAMAHA

SNOW  
ARCTIC CAT  
KAWASAKI  
LYNX  
MOTO-SKI  
POLARIS  
SKI DOO  
YAMAHA

MOPED & SCOOTER

MISC. TECH. SPECIAL







### HUSQVARNA

**DIRT**  
APRILIA  
BETA  
BMW  
GAS GAS  
HONDA  
HUSABERG  
HUSQVARNA  
KAWASAKI  
KTM  
MOTO TM  
RIEJU  
SHERCO  
SUZUKI  
YAMAHA

FE 450 4-Stroke Please Note: Nikasil Piston Size -Std. Compression 11.9:1 -Forged Piston -Fuel Injection -KTM Engine	<b>Piston Kit</b> 01.6432.A 01.6432.B 01.6432.C '14-19	<b>Size</b> 94.94 94.95 94.96	<b>Ring Set</b> 02.6429 02.6429 02.6429 '14-19	<b>Crank Bearing &amp; Seal Kit</b> 23.CBS64012 '14-16 23.CBS64016 '17-23  <b>Bearing</b> 23.SX07E39 '14-16 2x 23.NJ207ECP-1 '17-23 2x  <b>Oilseal Set</b> 42.6432 '14-16	<b>Con. Rod Kit</b> 03.6433 '14-16 03.6436 '17-23	<b>Complete</b> 34.6413 '14-16  <b>Top-End</b> 35.6438 '14-16 35.6417 '17-18 35.6439 '19-23  <b>Head &amp; Base</b> 36.6414 '14-16 36.6416 '17-23  <b>Ignition Cover Gasket</b> 19.G96433 '14-16 19.G96416 '17-23	<b>Cam Chain</b> 31.6428 '14-16 31.6328 '17-19 31.1335 '20-23  <b>Valve Shim Assortment</b> 29.VSA890 '14-23 29.VSA890-2 '14-23	<b>Valve</b> 28.6428-1 '14-19 2x Exhaust Steel 28.6433-2 '14-19 2x Intake Titanium 28.6420-1 '20-23 2x Exhaust Steel 28.6419-2 '20-23 2x Intake Titanium
---	--	--	--	---	---	---	---	--

**STREET**  
APRILIA  
CAGIVA  
HONDA  
KAWASAKI  
KTM  
SUZUKI  
YAMAHA

Please Note: Nikasil Piston Size -Std. Compression 12.75:1 -Forged Piston -Fuel Injection -KTM Engine	01.6440.A 01.6440.B 01.6440.C '20	94.95 94.96 94.97	TBA TBA TBA '20  <b>Pin</b> 04.1947.5 '14-19  <b>Clips</b> 05.1912 '14-19					
--	--	-------------------------	--	--	--	--	--	--

**ATV-UTV**  
CAN-AM  
GAS GAS  
HONDA  
KAWASAKI  
KTM  
POLARIS  
SUZUKI  
YAMAHA

--	--	--	--	--	--	--	--	--

**PWC**  
KAWASAKI  
POLARIS  
SEA DOO  
YAMAHA

FX 450 4-Stroke Please Note: Nikasil Piston Size -Std. Compression 12.6:1 -Forged Piston -Fuel Injection -KTM Engine	<b>Piston Kit</b> 01.6433.A 01.6433.B 01.6433.C '17-22	<b>Size</b> 94.95 94.96 94.97	<b>Ring Set</b> 02.6429 02.6429 02.6429 '17-22	<b>Crank Bearing &amp; Seal Kit</b> 23.CBS64016 '17-23  <b>Bearing</b> 23.NJ207ECP-1 '17-23 2x	<b>Con. Rod Kit</b> 03.6436 '17-23  <b>Crankpin</b> 06.3562 '17-23	<b>Top-End</b> 35.6419 '19-23  <b>Head &amp; Base</b> 36.6416 '17-23	<b>Cam Chain</b> 31.6428 '14-15 31.6328 '17-18 31.1335 '19-22 31.6443 '23	<b>Valve</b> 28.6433-1 '17-18 2x Exhaust Titanium 28.6433-2 '17-18 2x Intake Titanium 28.6419-1 '19-23 2x Exhaust Titanium 28.6419-2 '19-23 2x Intake Titanium
---	--	--	--	--	--	--	---	--

**SNOW**  
ARCTIC CAT  
KAWASAKI  
LYNX  
MOTO-SKI  
POLARIS  
SKI DOO  
YAMAHA

Please Note: Nikasil Piston Size -Std. Compression 13.1:1 -Forged Piston -Fuel Injection -KTM Engine	01.6443.A 01.6443.B 01.6443.C '23	94.96 94.97 94.98	TBA TBA TBA '23  <b>Clips</b> 05.1912 '17-22				<b>Valve Shim Assortment</b> 29.VSA890 '17-23 29.VSA890-2 '17-23	<b>Valve Seal</b> 35.VS026 '17-23 4x
---	--	-------------------------	---	--	--	--	--	--

**MOPED & SCOOTER**

--	--	--	--	--	--	--	--	--

**MISC. TECH. SPECIAL**

--	--	--	--	--	--	--	--	--

Footnotes: \* Bearings Only \*\* Rubbers included

**DIRT**  
APRILIA  
BETA  
BMW  
GAS GAS  
HONDA  
HUSABERG  
HUSQVARNA  
KAWASAKI  
KTM  
MOTO TM  
RIEJU  
SHERCO  
SUZUKI  
YAMAHA

<b>Air Filter</b> 52.62011 '14-16 52.62016 '17-23  <b>Throttle Cable</b> 53.110045 '14-16 53.112060 '17-19 53.112073 '20-23  <b>Oil Filter</b> 54.63655 '14-16 1-Pce. 54.63655-50 '14-16 50-Pcs. 54.63652 '17-23 1-Pce. 54.63652-50 '17-23 50-Pcs.  <b>Water Pump Rebuild Kit</b> 57.6424 '14-17	<b>Cover Gasket</b> 19.G6414 '14-23	<b>Complete Plate Set</b> 16.CPS64012 '14-23  <b>Friction Set</b> 16.S53011 '14-23  <b>Steel Set</b> 16.S53029 '14-23	<b>F/W Bearing</b> 23.S114002 '14-23  <b>R/W Bearing</b> 23.S112073 '14-23  <b>F/W Spacer Kit</b> 26.710087 '14-15 26.710103 '16-23  <b>R/W Spacer Kit</b> 26.710084 '14-23  <b>Steering Bearing</b> 24.110026 '14-23	<b>Frontbrake Disc</b> 37.BD16290 '14-23  <b>Rearbrake Disc</b> 37.BD26190 '14-23  <b>Front Pad Set</b> 37.102202 '14-23 37.102202BX '14-23 Box of 10  <b>Rear Pad Set</b> 37.202302 '14-23 37.202302BX '14-23 Box of 10  <b>Front Caliper Rebuild Kit</b> 37.63046 '14-17  <b>Rear Caliper Rebuild Kit</b> 37.63048 '14-16 37.RBPK003 '17	<b>Front Sprocket</b> 07.FS62093-12 07.FS62093-13 07.FS62093-14 07.FS62093-15 '14-23  <b>7075-T6 Alloy Rear Sprocket</b> 07.RA62090-48 07.RA62090-49 07.RA62090-50 07.RA62090-51 07.RA62090-52 '14-23  <b>Ultralight Steel Rear Sprocket</b> 07.RS62090R-48 07.RS62090R-49 07.RS62090R-50 07.RS62090R-51 07.RS62090R-52 '14-23  <b>Sprocket Bolt Set</b> 07.SBSM825 '14-23	<b>Chain</b> 07.RC520120C '14-23 MX 07.RC520120CG '14-23 MX Gold 07.RC520120XC '14-23 X-Ring 07.RC520120XCG '14-23 X-Ring Gold  <b>Countershaft Seal Kit</b> 26.640001 '14-23	<b>Swingarm</b> 26.210125 '14-23  <b>Linkage</b> 26.110180 '14-23  <b>Lower</b> 26.450066 '14-23  <b>Upper</b> 26.450068 '14-23	<b>Seal &amp; Wiper</b> 40.S4857.89 '14  <b>Oil Seal Set</b> 40.F4857.89 '14  <b>Dust Seal Set</b> 40.F4857.8D '14  <b>Bushing Set</b> 39.160082 '14  <b>Rear Shock Seal Head Kit</b> 26.810127 '14-20
--	---	---	---	--	---	---	---	--

**STREET**  
APRILIA  
CAGIVA  
HONDA  
KAWASAKI  
KTM  
SUZUKI  
YAMAHA

--	--	--	--	--	--	--	--	--

**ATV-UTV**  
CAN-AM  
GAS GAS  
HONDA  
KAWASAKI  
KTM  
POLARIS  
SUZUKI  
YAMAHA

--	--	--	--	--	--	--	--	--

**PWC**  
KAWASAKI  
POLARIS  
SEA DOO  
YAMAHA

<b>Air Filter</b> 52.62016 '17-22 52.62023 '23  <b>Oil Filter</b> 54.63652 '17-23 1-Pce. 54.63652-50 '17-23 50-Pcs.  <b>Throttle Cable</b> 53.112060 '17-18 53.112073 '19-22 53.112090 '23	<b>Cover Gasket</b> 19.G6414 '17-22  <b>Master Cylinder Rebuild Kit</b> 16.940011 '17 16.940012 '18-20 16.940000 '22  <b>Slave Cylinder Rebuild Kit</b> 16.950012 '17-20	<b>Complete Plate Set</b> 16.CPS64012 '17-23  <b>Friction Set</b> 16.S53011 '17-23  <b>Steel Set</b> 16.S53029 '17-23	<b>F/W Bearing</b> 23.S114002 '17-23  <b>R/W Bearing</b> 23.S112073 '17-22 23.S160023 '23  <b>F/W Spacer Kit</b> 26.710103 '17-23  <b>R/W Spacer Kit</b> 26.710102 '17-22  <b>Steering Bearing</b> 24.110026 '17-22	<b>Frontbrake Disc</b> 37.BD16290 '17-23  <b>Rearbrake Disc</b> 37.BD26190 '17-23  <b>Front Pad Set</b> 37.102202 '18-20 37.102202BX '17-23 Box of 10  <b>Rear Pad Set</b> 37.202302 '17-23 37.202302BX '17-23 Box of 10  <b>Front Caliper Rebuild Kit</b> 37.63046 '17 + '22-23  <b>Rear Caliper Rebuild Kit</b> 37.63048 '17 + '22  <b>Front Master Cylinder Rebuild Kit</b> 37.910035 '17 + '22-23  <b>Rear Master Cylinder Rebuild Kit</b> 37.910030 '17 + '22-23	<b>Front Sprocket</b> 07.FS62093-12 07.FS62093-13 07.FS62093-14 07.FS62093-15 '17-23  <b>7075-T6 Alloy Rear Sprocket</b> 07.RA62090-48 07.RA62090-49 07.RA62090-50 07.RA62090-51 07.RA62090-52 '17-23  <b>Ultralight Steel Rear Sprocket</b> 07.RS62090R-48 07.RS62090R-49 07.RS62090R-50 07.RS62090R-51 07.RS62090R-52 '17-23  <b>Sprocket Bolt Set</b> 07.SBSM825 '17-23	<b>Chain</b> 07.RC520120C '17-23 MX 07.RC520120CG '17-23 MX Gold 07.RC520120XC '17-23 X-Ring 07.RC520120XCG '17-23 X-Ring Gold  <b>Countershaft Seal Kit</b> 26.640001 '17-23	<b>Swingarm</b> 26.210125 '17-23  <b>Linkage</b> 26.110180 '17-20  <b>Upper</b> 26.450068 '17-23  <b>Lower</b> 26.450066 '17-20	<b>Rear Shock Seal Head Kit</b> 26.810127 '17-20
--	--	---	---	---	---	---	---	--

**SNOW**  
ARCTIC CAT  
KAWASAKI  
LYNX  
MOTO-SKI  
POLARIS  
SKI DOO  
YAMAHA

--	--	--	--	--	--	--	--	--

**MOPED & SCOOTER**

--	--	--	--	--	--	--	--	--

**MISC. TECH. SPECIAL**

--	--	--	--	--	--	--	--	--





### HUSQVARNA

**DIRT**  
APRILIA  
BETA  
BMW  
GAS GAS  
HONDA  
HUSABERG  
HUSQVARNA  
KAWASAKI  
KTM  
MOTO TM  
RIEJU  
SHERCO  
SUZUKI  
YAMAHA

FS 450 4-Stroke Please Note: Nikasil Piston Size -Std. Compression 12.6:1 -Forged Piston -Fuel Injection -KTM Engine	<b>Piston Kit</b> 01.6433.A 01.6433.B 01.6433.C '15-23	<b>Size</b> 94.95 94.96 94.97	<b>Ring Set</b> 02.6429 02.6429 02.6429 '15-23	<b>CrankBearing &amp; Seal Kit</b> 23.CBS64012 '15 23.CBS64016 '16-23	<b>Con. Rod Kit</b> 03.6433 '15 03.6436 '16-23	<b>Top-End</b> 35.6419 '19-23	<b>Cam Chain</b> 31.6428 '15 31.6328 '16-18 31.1335 '19-23	<b>Valve</b> 28.6433-1 '15-18 2x Exhaust Titanium 28.6419-1 '19-23 2x Exhaust Titanium 28.6433-2 '15-18 2x Intake Titanium 28.6419-2 '19-23 2x Intake Titanium  <b>Valve Seal</b> 35.VS026 '15-23 4x
---	--	--	--	---	--	-------------------------------------	--	--

**STREET**  
APRILIA  
CAGIVA  
HONDA  
KAWASAKI  
KTM  
SUZUKI  
YAMAHA

FE 501 4-Stroke Please Note: Nikasil Piston Size -Std. Compression 11.8:1 -Forged Piston -Fuel Injection -KTM Engine	<b>Piston Kit</b> 01.6512.A 01.6512.B 01.6512.C '14-19	<b>Size</b> 94.95 94.96 94.97	<b>Ring Set</b> 02.6429 02.6429 02.6429 '14-19	<b>CrankBearing &amp; Seal Kit</b> 23.CBS64012 '14-16 23.CBS64016 '17-23	<b>Complete</b> 34.6512 '14-16	<b>Top-End</b> 35.6438 '14-16 35.6417 '17-18 35.6439 '19-23	<b>Cam Chain</b> 31.6508 '14-16 31.1403 '17-19 31.6328 '20-23	<b>Valve</b> 28.6428-1 '14-19 2x Exhaust Steel 28.6433-2 '14-19 2x Intake Titanium 28.6420-1 '20-23 2x Exhaust Steel 28.6419-2 '20-23 2x Intake Titanium  <b>Valve Seal</b> 35.VS026 '14-23 2x Intake 35.VS028 '14-23 2x Intake
---	--	--	--	--	--------------------------------------	---	---	---

**ATV-UTV**  
CAN-AM  
GAS GAS  
HONDA  
KAWASAKI  
KTM  
POLARIS  
SUZUKI  
YAMAHA

FE 501 4-Stroke Please Note: Nikasil Piston Size -Std. Compression 11.8:1 -Forged Piston -Fuel Injection -KTM Engine	<b>Piston Kit</b> 01.6512.A 01.6512.B 01.6512.C '14-19	<b>Size</b> 94.95 94.96 94.97	<b>Ring Set</b> 02.6429 02.6429 02.6429 '14-19	<b>CrankBearing &amp; Seal Kit</b> 23.CBS64012 '14-16 23.CBS64016 '17-23	<b>Complete</b> 34.6512 '14-16	<b>Top-End</b> 35.6438 '14-16 35.6417 '17-18 35.6439 '19-23	<b>Cam Chain</b> 31.6508 '14-16 31.1403 '17-19 31.6328 '20-23	<b>Valve</b> 28.6428-1 '14-19 2x Exhaust Steel 28.6433-2 '14-19 2x Intake Titanium 28.6420-1 '20-23 2x Exhaust Steel 28.6419-2 '20-23 2x Intake Titanium  <b>Valve Seal</b> 35.VS026 '14-23 2x Intake 35.VS028 '14-23 2x Intake
---	--	--	--	--	--------------------------------------	---	---	---

**PWC**  
KAWASAKI  
POLARIS  
SEA DOO  
YAMAHA

			<b>Pin</b> 04.1947.5 '14-23					
--	--	--	-----------------------------------	--	--	--	--	--

**SNOW**  
ARCTIC CAT  
KAWASAKI  
LYNX  
MOTO-SKI  
POLARIS  
SKI DOO  
YAMAHA

			<b>Clips</b> 05.1912 '14-23					
--	--	--	-----------------------------------	--	--	--	--	--

**MOPED & SCOOTER**

--	--	--	--	--	--	--	--	--

**MISC. TECH. SPECIAL**

--	--	--	--	--	--	--	--	--

Footnotes: \* Bearings Only \*\* Rubbers included

**DIRT**  
APRILIA  
BETA  
BMW  
GAS GAS  
HONDA  
HUSABERG  
HUSQVARNA  
KAWASAKI  
KTM  
MOTO TM  
RIEJU  
SHERCO  
SUZUKI  
YAMAHA

<b>Air Filter</b> 52.62011 '15 52.62016 '16-22 52.62023 '23	<b>Cover Gasket</b> 19.G6414 '15-23	<b>Complete Plate Set</b> 16.CPS64012 '18-23	<b>F/W Bearing</b> 23.S114002 '15-23	<b>Rearbrake Disc</b> 37.BD26190 '15-23	<b>Front Sprocket</b> 07.FS62093-12 07.FS62093-13 07.FS62093-14 07.FS62093-15 '15-23	<b>Chain</b> 07.RC520120C '15-23 MX 07.RC520120CG '15-23 MX Gold 07.RC520120XC '15-23 X-Ring 07.RC520120XCG '15-23 X-Ring Gold	<b>Swingarm</b> 26.210125 '15-23	<b>Seal &amp; Wiper</b> 40.S4857.89 '15
---	---	--	--	---	---	--	--	---

**STREET**  
APRILIA  
CAGIVA  
HONDA  
KAWASAKI  
KTM  
SUZUKI  
YAMAHA

<b>Throttle Cable</b> 53.110045 '15 53.112060 '16-18 53.112073 '19-22 53.112090 '23	<b>Oil Filter</b> 54.63655 '15 1-Pce. 54.63655-50 '15 50-Pcs. 54.63652 '16-23 1-Pce. 54.63652-50 '16-23 50-Pcs.	<b>Master Cylinder Rebuild Kit</b> 16.940000 '14-16 16.940012 '17-21	<b>Friction Set</b> 16.S53011 '14-23	<b>Steel Set</b> 16.S53029 '14-23	<b>Slave Cylinder Rebuild Kit</b> 16.950003 '14-16 16.950012 '17-21	<b>F/W Spacer Kit</b> 26.710103 '14-15 26.710103 '16-23	<b>R/W Spacer Kit</b> 26.710103 '15-23	<b>Steering Bearing</b> 24.110026 '15-23	<b>Oil Filter</b> 54.63655 '15 1-Pce. 54.63655-50 '15 50-Pcs. 54.63652 '16-23 1-Pce. 54.63652-50 '16-23 50-Pcs.
---	---	--	--	---	---	---	--	--	---

**ATV-UTV**  
CAN-AM  
GAS GAS  
HONDA  
KAWASAKI  
KTM  
POLARIS  
SUZUKI  
YAMAHA

<b>Air Filter</b> 52.62011 '14-16 52.62016 '17-23	<b>Cover Gasket</b> 19.G6414 '14-23	<b>Complete Plate Set</b> 16.CPS64012 '14-23	<b>F/W Bearing</b> 23.S114002 '14-23	<b>Frontbrake Disc</b> 37.BD16290 '14-23	<b>Front Sprocket</b> 07.FS62093-12 07.FS62093-13 07.FS62093-14 07.FS62093-15 '14-23	<b>Chain</b> 07.RC520120C '14-23 MX 07.RC520120CG '14-23 MX Gold 07.RC520120XC '14-23 X-Ring 07.RC520120XCG '14-23 X-Ring Gold	<b>Swingarm</b> 26.210125 '14-23	<b>Seal &amp; Wiper</b> 40.S4857.89 '14
---	---	--	--	--	---	--	--	---

**PWC**  
KAWASAKI  
POLARIS  
SEA DOO  
YAMAHA

<b>Throttle Cable</b> 53.110045 '14-16 53.112061 '17-19 53.112073 '20-23	<b>Oil Filter</b> 54.63655 '14-16 1-Pce. 54.63655-50 '14-16 50-Pcs. 54.63652 '17-23 1-Pce. 54.63652-50 '17-23 50-Pcs.	<b>Master Cylinder Rebuild Kit</b> 16.940000 '14-16 16.940012 '17-21	<b>Friction Set</b> 16.S53011 '14-23	<b>Steel Set</b> 16.S53029 '14-23	<b>Slave Cylinder Rebuild Kit</b> 16.950003 '14-16 16.950012 '17-21	<b>F/W Spacer Kit</b> 26.710087 '14-15 26.710103 '16-23	<b>R/W Spacer Kit</b> 26.710084 '14-23	<b>Steering Bearing</b> 24.110026 '14-23	<b>Water Pump Rebuild Kit</b> 57.6522 '14-15 57.6423 '16
--	---	--	--	---	---	---	--	--	--

**SNOW**  
ARCTIC CAT  
KAWASAKI  
LYNX  
MOTO-SKI  
POLARIS  
SKI DOO  
YAMAHA

--	--	--	--	--	--	--	--	--

**MOPED & SCOOTER**

--	--	--	--	--	--	--	--	--

**MISC. TECH. SPECIAL**

--	--	--	--	--	--	--	--	--



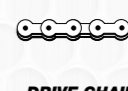

### HUSQVARNA

**DIRT**  
APRILIA  
BETA  
BMW  
GAS GAS  
HONDA  
HUSABERG  
HUSQVARNA  
KAWASAKI  
KTM  
MOTO TM  
RIEJU  
SHERCO  
SUZUKI  
YAMAHA

TC 510 4-Stroke Please Note: Nikasil Piston Size -Std. Compression 12.9:1 -Forged Piston	<b>Piston Kit</b> 01.6516.A 01.6516.B 01.6516.C '06-09	<b>Size</b> 96.95 96.96 96.97	<b>Ring Set</b> 02.6427 02.6427 02.6427 '06-09	<b>Pin</b> 04.2045 '06-09	<b>Clips</b> 05.2012 '06-09	<b>Con. Rod Kit</b> 03.6505 '06-09  <b>Crankpin</b> 06.3056.5 '06-09	<b>Valve Shim Assortment</b> 29.VSA948 '06-09  29.VSA948-2 '06-09	<b>Valve</b> 28.6425-1 '05 2x Exhaust Titanium 28.6425-2 '05 2x Intake Titanium
---	--	--	--	---------------------------------	-----------------------------------	--	--	---

**STREET**  
APRILIA  
CAGIVA  
HONDA  
KAWASAKI  
KTM  
SUZUKI  
YAMAHA

TE 510 4-Stroke Please Note: Nikasil Piston Size -Std. Compression 12.9:1 -Forged Piston	<b>Piston Kit</b> 01.6518.A 01.6518.B 01.6518.C '08-10	<b>Size</b> 96.95 96.96 96.97	<b>Ring Set</b> 02.2440 02.2440 02.2440 '08-10	<b>Clips</b> 05.2012 '08-10	<b>Con. Rod Kit</b> 03.6505 '08-10  <b>Crankpin</b> 06.3056.5 '08-10	<b>Valve Shim Assortment</b> 29.VSA948 '08-10  29.VSA948-2 '08-10		
---	--	--	--	-----------------------------------	--	--	--	--

**PWC**  
KAWASAKI  
POLARIS  
SEA DOO  
YAMAHA

								<b>Oil Filter</b> 54.63563 '08-10 1-Pce. 54.63563-50 '08-10 50-Pcs.
--	--	--	--	--	--	--	--	---

**SNOW**  
ARCTIC CAT  
KAWASAKI  
LYNX  
MOTO-SKI  
POLARIS  
SKI DOO  
YAMAHA

--	--	--	--	--	--	--	--	--

**MOPED & SCOOTER**

--	--	--	--	--	--	--	--	--

**MISC. TECH. SPECIAL**

--	--	--	--	--	--	--	--	--

Footnotes: \* Bearings Only \*\* Rubbers included

**DIRT**  
APRILIA  
BETA  
BMW  
GAS GAS  
HONDA  
HUSABERG  
HUSQVARNA  
KAWASAKI  
KTM  
MOTO TM  
RIEJU  
SHERCO  
SUZUKI  
YAMAHA

<b>Air Filter</b> 52.63092 '03-10			<b>F/W Bearing</b> 23.S114015 '05-09	<b>Frontbrake Disc</b> 37.BD16200 '04-10	<b>Front Sprocket</b> 07.FS63000-12 07.FS63000-13 07.FS63000-14 07.FS63000-15 '05-09	<b>Chain</b> 07.RC520120C '03-09 MX 07.RC520120CG '03-09 MX Gold 07.RC520120XC '03-09 X-Ring 07.RC520120XCG '03-09 X-Ring Gold	<b>Swingarm</b> 26.210119 '05-07 26.210199 '08-09		
<b>Main Jet</b> 45.100-225 '05-09 Keihin			<b>R/W Bearing</b> 23.S114020 '05-09	<b>Front Pad Set</b> 37.102202 '05-10 37.102202BX '05-10 Box of 10	<b>7075-T6 Alloy Rear Sprocket</b> 07.RA62097-46 07.RA62097-47 07.RA62097-48 07.RA62097-49 07.RA62097-50 07.RA62097-51 07.RA62097-52 '06-09	<b>Lower Chain Roller</b> 33.0001 '05-10	<b>Linkage</b> 26.110147 '05-07 26.110176 '08-09		
<b>Pilot Jet</b> 46.040-085 '05-09 Keihin			<b>Steering Bearing</b> 24.110061 '05-09	<b>Rear Pad Set</b> 37.202302 '05-10 37.202302BX '05-10 Box of 10	<b>Upper Chain Roller</b> 33.0001 '05-10	<b>Upper</b> 26.350080 '05	<b>Lower</b> 26.450044 '05-07 26.450062 '08-09		
<b>Carburetor Rebuild Kit</b> 55.10521 '05-09					<b>Ultralight Steel Rear Sprocket</b> 07.RS62097R-46 07.RS62097R-47 07.RS62097R-48 07.RS62097R-49 07.RS62097R-50 07.RS62097R-51 07.RS62097R-52 '06-09	<b>Sprocket Bolt Set</b> 07.SBSM825 '06-09			
<b>Throttle Cable</b> 53.110053 '05-09									
<b>Oil Filter</b> 54.63154 '05-07 1-Pce. 54.63154-50 '05-07 50-Pcs. 54.63563 '08-10 1-Pce. 54.63563-50 '08-10 50-Pcs.									

**STREET**  
APRILIA  
CAGIVA  
HONDA  
KAWASAKI  
KTM  
SUZUKI  
YAMAHA

<b>Air Filter</b> 52.63092 '03-10	<b>Friction Set</b> 16.S14015 '08-10	<b>F/W Bearing</b> 23.S114015 '04-10	<b>Frontbrake Disc</b> 37.BD16200 '04-10	<b>Front Sprocket</b> 07.FS63000-12 07.FS63000-13 07.FS63000-14 07.FS63000-15 '05-10	<b>Chain</b> 07.RC520120C '03-10 MX 07.RC520120CG '03-10 MX Gold 07.RC520120XC '03-10 X-Ring 07.RC520120XCG '03-10 X-Ring Gold	<b>Swingarm</b> 26.210119 '04-07 26.210199 '08-10	<b>Seal &amp; Wiper</b> 40.S485810 '10
<b>Carburetor Rebuild Kit</b> 55.10521 '05-07	<b>Steel Set</b> 16.S14016 '08-10	<b>R/W Bearing</b> 23.S114020 '04-10	<b>Front Pad Set</b> 37.102202 '04-10 37.102202BX '04-10 Box of 10	<b>7075-T6 Alloy Rear Sprocket</b> 07.RA62097-46 07.RA62097-47 07.RA62097-48 07.RA62097-49 07.RA62097-50 07.RA62097-51 07.RA62097-52 '06-10	<b>Lower Chain Roller</b> 33.0001 '04-10	<b>Upper</b> 26.350080 '04-07	<b>Oil Seal Set</b> 40.F485810 '10
<b>Throttle Cable</b> 53.112015 '04 53.110053 '05-07 53.112020 '08-10		<b>Steering Bearing</b> 24.110032 '04-07 24.110061 '08-10	<b>Rear Pad Set</b> 37.202302 '06-10 37.202302BX '06-10 Box of 10	<b>Upper Chain Roller</b> 33.0001 '04-10	<b>Dust Seal Set</b> 40.F4858D '10	<b>Bushing Set</b> 39.160068 '10	<b>Rear Shock Seal Head Kit</b> 26.810124 '04
<b>Oil Filter</b> 54.63563 '08-10 1-Pce. 54.63563-50 '08-10 50-Pcs.				<b>Ultralight Steel Rear Sprocket</b> 07.RS62097R-46 07.RS62097R-47 07.RS62097R-48 07.RS62097R-49 07.RS62097R-50 07.RS62097R-51 07.RS62097R-52 '06-10	<b>Sprocket Bolt Set</b> 07.SBSM825 '06-10	<b>Lower</b> 26.450044 '04-07 26.450062 '08-10	

**PWC**  
KAWASAKI  
POLARIS  
SEA DOO  
YAMAHA

--	--	--	--	--	--	--	--

**SNOW**  
ARCTIC CAT  
KAWASAKI  
LYNX  
MOTO-SKI  
POLARIS  
SKI DOO  
YAMAHA

--	--	--	--	--	--	--	--

**MOPED & SCOOTER**

--	--	--	--	--	--	--	--

**MISC. TECH. SPECIAL**

--	--	--	--	--	--	--	--





### HUSQVARNA

**DIRT**  
APRILIA  
BETA  
BMW  
GAS GAS  
HONDA  
HUSABERG  
HUSQVARNA  
KAWASAKI  
KTM  
MOTO TM  
RIEJU  
SHERCO  
SUZUKI  
YAMAHA

<b>TXC 510</b> 4-Stroke Please Note: Nikasil Piston Size -Std. Compression 12.9:1 -Forged Piston	<b>Piston Kit</b> 01.6516.A 01.6516.B 01.6516.C '08-10	<b>Size</b> 96.95 96.96 96.97	<b>Ring Set</b> 02.6427 02.6427 02.6427 '08-10	<b>Pin</b> 04.2045 '08-10	<b>Con. Rod Kit</b> 03.6505 '08-10	<b>Crankpin</b> 06.3056.5 '08-10	<b>Valve Shim Assortment</b> 29.VSA948 '08-10 29.VSA948-2 '08-10
			<b>Clips</b> 05.2012 '08-10				

**STREET**  
APRILIA  
CAGIVA  
HONDA  
KAWASAKI  
KTM  
SUZUKI  
YAMAHA

<b>SMR 510</b> 4-Stroke Please Note: Nikasil Piston Size -Std. Compression 12.9:1 -Forged Piston	<b>Piston Kit</b> 01.6518.A 01.6518.B 01.6518.C '08-10	<b>Size</b> 96.95 96.96 96.97	<b>Ring Set</b> 02.2440 02.2440 02.2440 '08-10	<b>Clips</b> 05.2012 '08-10	<b>Con. Rod Kit</b> 03.6505 '08-10	<b>Crankpin</b> 06.3056.5 '08-10	<b>Valve Shim Assortment</b> 29.VSA948 '08-10 29.VSA948-2 '08-10
---	--	--	--	-----------------------------------	--	--	--

**PWC**  
KAWASAKI  
POLARIS  
SEA DOO  
YAMAHA

--	--	--	--	--	--	--	--

**SNOW**  
ARCTIC CAT  
KAWASAKI  
LYNX  
MOTO-SKI  
POLARIS  
SKI DOO  
YAMAHA

--	--	--	--	--	--	--	--

**MOPED & SCOOTER**

Footnotes: \* Bearings Only \*\* Rubbers included

**MISC. TECH. SPECIAL**

**DIRT**  
APRILIA  
BETA  
BMW  
GAS GAS  
HONDA  
HUSABERG  
HUSQVARNA  
KAWASAKI  
KTM  
MOTO TM  
RIEJU  
SHERCO  
SUZUKI  
YAMAHA

<b>Air Filter</b> 52.63092 '08-10	<b>Friction Set</b> 16.S14015 '08-10	<b>F/W Bearing</b> 23.S114015 '08-10	<b>Frontbrake Disc</b> 37.BD16200 '08-10	<b>Front Sprocket</b> 07.FS63000-12 07.FS63000-13 07.FS63000-14 07.FS63000-15 '08-10	<b>Chain</b> 07.RC520120C '08-10 MX 07.RC520120CG '08-10 MX Gold 07.RC520120XC '08-10 X-Ring 07.RC520120XCG '08-10 X-Ring Gold	<b>Swingarm</b> 26.210199 '08-10	<b>Seal &amp; Wiper</b> 40.S485810 '10
<b>Main Jet</b> 45.100-225 '08-10 Keihin	<b>Steel Set</b> 16.S14016 '08-10	<b>R/W Bearing</b> 23.S114020 '08-10	<b>Front Pad Set</b> 37.102202 '08-10 37.102202BX '08-10 Box of 10	<b>7075-T6 Alloy Rear Sprocket</b> 07.RA62097-46 07.RA62097-47 07.RA62097-48 07.RA62097-49 07.RA62097-50 07.RA62097-51 07.RA62097-52 '08-10	<b>Lower Chain Roller</b> 33.0001 '08-10	<b>Linkage</b> 26.110176 '08-10	<b>Oil Seal Set</b> 40.F485810 '10
<b>Pilot Jet</b> 46.040-085 '08-10 Keihin		<b>Steering Bearing</b> 24.110061 '08-10	<b>Rear Pad Set</b> 37.202302 '08-10 37.202302BX '08-10 Box of 10	<b>UltraLight Steel Rear Sprocket</b> 07.RS62097R-46 07.RS62097R-47 07.RS62097R-48 07.RS62097R-49 07.RS62097R-50 07.RS62097R-51 07.RS62097R-52 '08-10	<b>Upper Chain Roller</b> 33.0001 '08-10	<b>Dust Seal Set</b> 40.F4858D '10	<b>Bushing Set</b> 39.160068 '10
<b>Carburetor Rebuild Kit</b> 55.10521 '08-10				<b>Sprocket Bolt Set</b> 07.SBSM825 '08-10			
<b>Throttle Cable</b> 53.110053 '08-10							
<b>Oil Filter</b> 54.63563 '08-10 1-Pce. 54.63563-50 '08-10 50-Pcs.							

**STREET**  
APRILIA  
CAGIVA  
HONDA  
KAWASAKI  
KTM  
SUZUKI  
YAMAHA

<b>Air Filter</b> 52.63092 '08-10	<b>Friction Set</b> 16.S14015 '08-10	<b>F/W Bearing</b> 23.S114015 '05-10		<b>Front Sprocket</b> 07.FS63000-12 07.FS63000-13 07.FS63000-14 07.FS63000-15 '05-10	<b>Chain</b> 07.RC520120C '05-10 MX 07.RC520120CG '05-10 MX Gold 07.RC520120XC '05-10 X-Ring 07.RC520120XCG '05-10 X-Ring Gold	<b>Swingarm</b> 26.210119 '05-07 26.210199 '08-10	<b>Bushing Set</b> 39.160068 '10
<b>Carburetor Rebuild Kit</b> 55.10521 '05-07	<b>Steel Set</b> 16.S14016 '08-10	<b>R/W Bearing</b> 23.S114020 '05-10		<b>7075-T6 Alloy Rear Sprocket</b> 07.RA62097-46 07.RA62097-47 07.RA62097-48 07.RA62097-49 07.RA62097-50 07.RA62097-51 07.RA62097-52 '08-10	<b>Linkage</b> 26.110147 '05-07 26.110176 '08-10	<b>Upper</b> 26.350080 '05-07	
<b>Throttle Cable</b> 53.110053 '05-07 53.112020 '08-09		<b>Steering Bearing</b> 24.110032 '05-07 24.110061 '08-10		<b>UltraLight Steel Rear Sprocket</b> 07.RS62097R-46 07.RS62097R-47 07.RS62097R-48 07.RS62097R-49 07.RS62097R-50 07.RS62097R-51 07.RS62097R-52 '08-10	<b>Lower</b> 26.450044 '05-07 26.450062 '08-10		
<b>Oil Filter</b> 54.63563 '08-10 1-Pce. 54.63563-50 '08-10 50-Pcs.				<b>Sprocket Bolt Set</b> 07.SBSM825 '08-10			

**ATV-UTV**  
CAN-AM  
GAS GAS  
HONDA  
KAWASAKI  
KTM  
POLARIS  
SUZUKI  
YAMAHA

--	--	--	--	--	--	--	--

**PWC**  
KAWASAKI  
POLARIS  
SEA DOO  
YAMAHA

--	--	--	--	--	--	--	--

**SNOW**  
ARCTIC CAT  
KAWASAKI  
LYNX  
MOTO-SKI  
POLARIS  
SKI DOO  
YAMAHA

Footnotes: \* Bearings Only \*\* Rubbers included

**MOPED & SCOOTER**

Footnotes: \* Bearings Only \*\* Rubbers included

**MISC. TECH. SPECIAL**



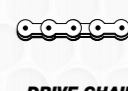

### HUSQVARNA

**DIRT**  
APRILIA  
BETA  
BMW  
GAS GAS  
HONDA  
HUSABERG  
HUSQVARNA  
KAWASAKI  
KTM  
MOTO TM  
RIEJU  
SHERCO  
SUZUKI  
YAMAHA

TC / TE 610  
4-Stroke  
Please Note:  
Nikasil Piston Size  
-Std. Compression 10.0:1  
-Forged Piston

**Piston Kit**  
01.6601.A  
01.6601.B  
01.6601.C  
'99-03

**SIZES (mm)**  
97.94  
97.95  
97.96

**Piston Parts**  
**Ring Set**  
02.6601  
02.6601  
02.6601  
'99-03

**STREET**  
APRILIA  
CAGIVA  
HONDA  
KAWASAKI  
KTM  
SUZUKI  
YAMAHA

Please Note:  
Nikasil Piston Size  
-High Compression 11.0:1  
-Forged Piston

**High Compression**  
01.6602.A  
'99-03

**Size**  
97.94

**Ring Set**  
02.6601  
'99-03

**Clips**  
05.2216  
'99-03

**ATV-UTV**  
CAN-AM  
GAS GAS  
HONDA  
KAWASAKI  
KTM  
POLARIS  
SUZUKI  
YAMAHA

**PWC**  
KAWASAKI  
POLARIS  
SEA DOO  
YAMAHA

**SNOW**  
ARCTIC CAT  
KAWASAKI  
LYNX  
MOTO-SKI  
POLARIS  
SKI DOO  
YAMAHA

**MOPED & SCOOTER**

**MISC. TECH. SPECIAL**

Footnotes: \* Bearings Only \*\* Rubbers included

**Throttle Cable**  
53.110053  
'06-08 TE  
**Oil Filter**  
54.63154  
'98-08 TE 1-Pce.  
54.63154-50  
'98-08 TE 50-Pcs.

**F/W Bearing**  
23.S114017  
'96-99  
23.S114013  
'00  
23.S114015  
'01 TC  
23.S114016  
'01 TE  
23.S114017  
'02-04 TE  
23.S114015  
'05-08 TE  
**R/W Bearing**  
23.S114019  
'96-98  
23.S114018  
'99  
23.S114020  
'00-01  
23.S115035  
'02-03 TE  
23.S114020  
'06-08 TE  
**Steering Bearing**  
24.110032  
'98 TC  
24.110061  
'99-00 TC  
24.110032  
'98-01 + 07 TE  
24.110061  
'08 TE

**Frontbrake Disc**  
37.BD16200  
'00-10  
**Front Pad Set**  
37.102202  
'95-00  
37.102202BX  
'95-00 Box of 10  
**Rear Pad Set**  
37.204202  
'95-00  
37.204202BX  
'95-00 Box of 10

**Chain**  
07.RC520120C  
'91-07 MX  
07.RC520120CG  
'91-07 MX Gold  
07.RC520120XC  
'91-07 X-Ring  
07.RC520120XCG  
'91-07 X-Ring  
**Lower Chain Roller**  
33.0001  
'96-03 + 06-07  
**Upper Chain Roller**  
33.0001  
'96-03 + 06-07

**Upper**  
26.350080  
'98-01 TC  
'98-07 TE

**DIRT**  
APRILIA  
BETA  
BMW  
GAS GAS  
HONDA  
HUSABERG  
HUSQVARNA  
KAWASAKI  
KTM  
MOTO TM  
RIEJU  
SHERCO  
SUZUKI  
YAMAHA

**STREET**  
APRILIA  
CAGIVA  
HONDA  
KAWASAKI  
KTM  
SUZUKI  
YAMAHA

**ATV-UTV**  
CAN-AM  
GAS GAS  
HONDA  
KAWASAKI  
KTM  
POLARIS  
SUZUKI  
YAMAHA

**PWC**  
KAWASAKI  
POLARIS  
SEA DOO  
YAMAHA

**SNOW**  
ARCTIC CAT  
KAWASAKI  
LYNX  
MOTO-SKI  
POLARIS  
SKI DOO  
YAMAHA

**MOPED & SCOOTER**

**MISC. TECH. SPECIAL**





### KAWASAKI

#### DIRT

- APRILIA
- BETA
- BMW
- GAS GAS
- HONDA
- HUSABERG
- HUSQVARNA
- KAWASAKI**
- KTM
- MOTO TM
- RIEJU
- SHERCO
- SUZUKI
- YAMAHA

KX 60 2-Stroke Please Note: Nikasil Piston Size	<b>Piston Kit</b> 01.4100.A 01.4100.B '88-04	<b>Size</b> 42.95 42.96	<b>Ring Set</b> 02.4100 02.4100 '88-04	<b>CrankBearing &amp; Seal Kit</b> 23.CBS41088 '88-04	<b>Con. Rod Kit</b> 03.4022 '85-04	<b>Complete</b> 34.4100 '85-04		
			<b>Pin</b> 04.1236.4 '88-04	<b>Bearing</b> 23.6304C3 '85-04 2x	<b>S/E Bearing</b> 21.4100 '83-04	<b>Top-End</b> 35.4100.90 '85-04		
			<b>Clips</b> 05.1210C '88-04	<b>Oilseal Set</b> 42.4105 '85-04	<b>B/E Bearing</b> 22.202714F '85-04	<b>Head &amp; Base</b> 36.4185 '85-04		
					<b>Crankpin</b> 06.2046 '85-04	<b>Ignition Cover Gasket</b> 19.G94085 '85-04		

#### STREET

- APRILIA
- CAGIVA
- HONDA
- KAWASAKI**
- KTM
- SUZUKI
- YAMAHA

KX 65 2-Stroke Please Note: Nikasil Piston Size -Molycoated Skirt	<b>Piston Kit</b> 01.4022.A 01.4022.B 01.4022.C 01.4022.D '00-23	<b>Size</b> 44.45 44.46 44.47 44.48	<b>Ring Set</b> 02.4021 02.4021 02.4021 02.4021 '00-23	<b>CrankBearing &amp; Seal Kit</b> 23.CBS41088 '00-23	<b>Con. Rod Kit</b> 03.4022 '00-23	<b>Complete</b> 34.4021 '00-05 34.4027 '06-21		
			<b>Pin</b> 04.1236.4 '00-23	<b>Bearing</b> 23.6304C3 '00-23 2x	<b>S/E Bearing</b> 21.4100 '00-23	<b>Top-End</b> 35.4021 '00-23		
			<b>Clips</b> 05.1210C '00-23	<b>Oilseal Set</b> 42.4105 '00-23	<b>B/E Bearing</b> 22.202714F '00-23	<b>Head &amp; Base</b> 36.4100 '00-23		
					<b>Crankpin</b> 06.2046 '00-23	<b>Ignition Cover Gasket</b> 19.G94085 '00-05 19.G94006 '06-23		

#### ATV-UTV

- CAN-AM
- GAS GAS
- HONDA
- KAWASAKI**
- KTM
- POLARIS
- SUZUKI
- YAMAHA

#### PWC

- KAWASAKI**
- POLARIS
- SEA DOO
- YAMAHA

#### SNOW

- ARCTIC CAT
- KAWASAKI**
- LYNX
- MOTO-SKI
- POLARIS
- SKI DOO
- YAMAHA

#### MOPED & SCOOTER

#### MISC. TECH. SPECIAL

KDX 80 2-Stroke	<b>Piston Kit</b> -	<b>Size</b> -	<b>Ring Set</b> -					
--------------------	------------------------	------------------	----------------------	--	--	--	--	--

Footnotes: \* Bearings Only \*\* Rubbers included

#### DIRT

- APRILIA
- BETA
- BMW
- GAS GAS
- HONDA
- HUSABERG
- HUSQVARNA
- KAWASAKI**
- KTM
- MOTO TM
- RIEJU
- SHERCO
- SUZUKI
- YAMAHA

<b>Air Filter</b> 52.40086 '86-04	<b>Basket</b> 17.4085F '85-04	<b>Complete Plate Set</b> 16.CPS41088 '88-04	<b>F/W Bearing</b> 23.S111065 '83-04		<b>Front Sprocket</b> 07.FS41086-12 07.FS41086-13 07.FS41086-14 07.FS41086-15 '85-04	<b>Chain</b> 07.RC420130C '83-04 MX	<b>Swingarm</b> 26.210067 '83-04	
<b>Throttle Cable</b> 53.112004 '88-04	<b>Spring Kit</b> 17.CS40012 '83-04	<b>Friction Set</b> 16.S41001 '88-04	<b>R/W Bearing</b> 23.S111081 '83-04			<b>Countershaft Seal Kit</b> 26.640018 '83-04	<b>Linkage</b> 26.110059 '85-04	
<b>Water Pump Rebuild Kit</b> 57.3023 '85-04	<b>Cover Gasket</b> 19.G4085 '88-04	<b>Steel Set</b> 16.S41002 '88-04	<b>Steering Bearing</b> 24.110040 '83-04			<b>Lower Chain Roller</b> 33.0009 '83-04	<b>Upper</b> 26.450040 '85-04	
	<b>Clutch Cable</b> 53.121005 '88-04					<b>Upper Chain Roller</b> 33.0009 '83-04		

<b>Air Filter</b> 52.40000 '00-23	<b>Basket</b> 17.4085F '00-23	<b>Complete Plate Set</b> 16.CPS41088 '00-23	<b>F/W Bearing</b> 23.S111081 '00-23	<b>Frontbrake Disc</b> 37.BD14000 '00-23	<b>Front Sprocket</b> 07.FS41086-12 07.FS41086-13 07.FS41086-14 07.FS41086-15 '00-23	<b>Chain</b> 07.RC420130C '00-23 MX	<b>Swingarm</b> 26.210067 '00-23	<b>Seal &amp; Wiper</b> 40.S334611P '00-23
<b>Main Jet</b> 47.090-580 '00-23 Mikuni	<b>Spring Kit</b> 17.CS40012 '00-23	<b>Friction Set</b> 16.S41001 '00-23	<b>R/W Bearing</b> 23.S111081 '00-23	<b>Rearbrake Disc</b> 37.BD14000 '00-23		<b>Countershaft Seal Kit</b> 26.640018 '00-04 26.640017 '05-23	<b>Linkage</b> 26.110012 '00-01 26.110011 '02-23	<b>Oil Seal Set</b> 40.F334611P '00-23
<b>Pilot Jet</b> 48.015-080 '00-23 Mikuni	<b>Cover Gasket</b> 19.G4090 '00-23	<b>Steel Set</b> 16.S41002 '00-23	<b>F/W Spacer Kit</b> 26.710024 '00-23	<b>Front Pad Set</b> 37.107202 '00-23 37.107202BX '00-23 Box of 10	<b>7075-T6 Alloy Rear Sprocket</b> 07.RA40000-46 07.RA40000-47 07.RA40000-48 '00-23	<b>Lower Chain Roller</b> 33.0012 '00-23	<b>Lower</b> 26.450022 '00-23	<b>Dust Seal Set</b> 40.F3346DP '00-23
<b>Carburetor Rebuild Kit</b> 55.10562 '00-01 55.10108 '02-21	<b>Clutch Cable</b> 53.121006 '00-23		<b>Steering Bearing</b> 24.110022 '00-23	<b>Rear Pad Set</b> 37.202002 '00-23 37.202002BX '00-23 Box of 10	<b>Sprocket Bolt Set</b> 07.SBSM825 '00-23	<b>Upper Chain Roller</b> 33.0009 '00-23		<b>Rear Shock Seal Head Kit</b> 26.810005 '00-23
<b>Throttle Cable</b> 53.112004 '00-23				<b>Front Caliper Rebuild Kit</b> 37.63001 '00-23				
<b>Water Pump Rebuild Kit</b> 57.4023 '00-05 57.4026 '06-23				<b>Rear Caliper Rebuild Kit</b> 37.63033 '00-23				
				<b>Front Master Cylinder Rebuild Kit</b> 37.910010 '00-23				
				<b>Rear Master Cylinder Rebuild Kit</b> 37.910007 '00-23				

#### STREET

- APRILIA
- CAGIVA
- HONDA
- KAWASAKI**
- KTM
- SUZUKI
- YAMAHA

#### ATV-UTV

- CAN-AM
- GAS GAS
- HONDA
- KAWASAKI**
- KTM
- POLARIS
- SUZUKI
- YAMAHA

#### PWC

- KAWASAKI**
- POLARIS
- SEA DOO
- YAMAHA

#### SNOW

- ARCTIC CAT
- KAWASAKI**
- LYNX
- MOTO-SKI
- POLARIS
- SKI DOO
- YAMAHA

#### MOPED & SCOOTER

#### MISC. TECH. SPECIAL

<b>Throttle Cable</b> 53.112003 '87-88			<b>F/W Bearing</b> 23.S111065 '80-88			<b>Chain</b> 07.RC420130C '81-88 MX	<b>Swingarm</b> 26.210067 '84-88	
			<b>R/W Bearing</b> 23.S111081 '84-88				<b>Linkage</b> 26.110110 '84-88	





PISTON KITS



SIZES (mm)



PISTON PARTS



CRANKSHAFT PARTS



CONNECTING ROD PARTS



GASKETS



VALVE TRAIN PARTS I



VALVE TRAIN PARTS II



AIR & FUEL PARTS



CLUTCH PARTS



CLUTCH PLATE SETS



WHEEL & STEERING PARTS



BRAKE PARTS



DRIVE CHAIN PARTS I



DRIVE CHAIN PARTS II



SUSPENSION BEARING KITS



SUSPENSION PARTS



X

**KAWASAKI**

**DIRT**  
APRILIA  
BETA  
BMW  
GAS GAS  
HONDA  
HUSABERG  
HUSQVARNA  
KAWASAKI  
KTM  
MOTO TM  
RIEJU  
SHERCO  
SUZUKI  
YAMAHA

**STREET**  
APRILIA  
CAGIVA  
HONDA  
KAWASAKI  
KTM  
SUZUKI  
YAMAHA

**ATV-UTV**  
CAN-AM  
GAS GAS  
HONDA  
KAWASAKI  
KTM  
POLARIS  
SUZUKI  
YAMAHA

**PWC**  
KAWASAKI  
POLARIS  
SEA DOO  
YAMAHA

**SNOW**  
ARCTIC CAT  
KAWASAKI  
LYNX  
MOTO-SKI  
POLARIS  
SKI DOO  
YAMAHA

**MOPED & SCOOTER**

**MISC. TECH. SPECIAL**

	Piston Kit	Size	Ring Set	Crank Bearing & Seal Kit	Con. Rod Kit	Complete
KX 80 International Bore 79cc 2-Stroke Please Note: Nikasil Piston Size	01.4118.A 01.4118.B 01.4118.C 01.4118.D '88-00	46.95 46.96 46.97 46.98	02.4114 02.4114 02.4114 02.4114 '88-00	23.CBS41082 '82-84 23.CBS41088 '85-00	03.4108 '82-97 03.4118 '98-00	34.4101 '91-97 34.4108 '98-00
USA Bore 82cc Please Note: Nikasil Piston Size	01.4108.A 01.4108.B 01.4108.C 01.4108.D '90-00	47.94 47.95 47.96 47.97	02.4106 02.4106 02.4106 02.4106 '90-00	Bearing 23.6304C3 '82-00 2x  Oilseal Set 42.4105 '85-00	S/E Bearing 21.4103 '82-00  B/E Bearing 22.222914F '82-97 22.222916F '98-00  Crankpin 06.2246 '82-00	Top-End 35.4189 '88-89 35.4110 '90 35.4111 '91-97 35.4118 '98-00  Head & Base 36.4101 '98-00  Ignition Cover Gasket 19.G94085 '83-89 19.G94190 '90-00
			Pin 04.1439.5 '81-00  Clips 05.1410C '81-00			
KX 85 2-Stroke Please Note: Nikasil Piston Size	01.4121.A 01.4121.B 01.4121.C '01-13	48.45 48.46 48.47	02.4121 02.4121 02.4121 '01-13	23.CBS41088 '01-23  Bearing 23.6304C3 '01-23 2x  Oilseal Set 42.4105 '01-23	03.4118 '01-23  S/E Bearing 21.4103 '01-23  B/E Bearing 22.222916F '01-23  Crankpin 06.2246 '01-23	34.4121 '01-06 34.4127 '07-13 34.4124 '14-21  Top-End 35.4121 '01-13 35.4124 '14-23  Head & Base 36.4101 '01-13 36.4114 '14-23  Ignition Cover Gasket 19.G94190 '01-05 19.G94107 '06-21
Please Note: Nikasil Piston Size	01.4124.A 01.4124.B 01.4124.C '14-23	48.45 48.46 48.47	02.4124 02.4124 02.4124 '14-23			
			Pin 04.1439.5 '01-13  Clips 05.1410C '01-23			

Footnotes: \* Bearings Only \*\* Rubbers included

**DIRT**  
APRILIA  
BETA  
BMW  
GAS GAS  
HONDA  
HUSABERG  
HUSQVARNA  
KAWASAKI  
KTM  
MOTO TM  
RIEJU  
SHERCO  
SUZUKI  
YAMAHA

**STREET**  
APRILIA  
CAGIVA  
HONDA  
KAWASAKI  
KTM  
SUZUKI  
YAMAHA

**ATV-UTV**  
CAN-AM  
GAS GAS  
HONDA  
KAWASAKI  
KTM  
POLARIS  
SUZUKI  
YAMAHA

**PWC**  
KAWASAKI  
POLARIS  
SEA DOO  
YAMAHA

**SNOW**  
ARCTIC CAT  
KAWASAKI  
LYNX  
MOTO-SKI  
POLARIS  
SKI DOO  
YAMAHA

**MOPED & SCOOTER**

**MISC. TECH. SPECIAL**

Air Filter	Basket	Complete Plate Set	F/W Bearing	Front Pad Set	Front Sprocket	Chain	Swingarm	Seal & Wiper
52.41091 '91-00	17.4188 * '88-97 17.4198F * '98-00	16.CPS41098 '98-00	23.S111065 '79-83 23.S111077 '86-97 23.S111081 '98-00	37.106002 '88-96 37.106002BX '88-96 Box of 10 37.106202 '97-00 37.106202BX '97-00 Box of 10	07.FS41086-12 07.FS41086-13 07.FS41086-14 07.FS41086-15 '86-00	07.RC420130C '79-00 MX	26.210067 '83-00	40.S354811 '86-91 40.S36488P '98-00
Main Jet 45.100-225 '90-00 Keihin	Clutch Rubber Set 17.CRS4198-6 '88-00	Friction Set 16.S41001 '81-84 16.S41005 '85 16.S41007 '88 16.S41009 '98-00	R/W Bearing 23.S111081 '83-85 23.S111071 '88-97 23.S110033 '98-00	Rear Pad Set 37.200802 '88-00 37.200802BX '88-00 Box of 10	7075-T6 Alloy Rear Sprocket 07.RA41086-49 07.RA41086-50 07.RA41086-51 07.RA41086-52 07.RA41086-53 '86-00	Countershaft Seal Kit 26.640018 '83-00	Linkage 26.110110 '83-85 26.110013 '91-97 26.110014 '98-00	Oil Seal Set 40.F354811 '86-91 40.F385011 '92-97 40.F36488P '98-00
Pilot Jet 46.040-085 '90-00 Keihin	Spring Kit 17.CS41013 '98-00	Steel Set 16.S41002 '81-84 16.S41006 '85 16.S41008 '88-90 16.S41010 '98-00	F/W Spacer Kit 26.710025 '98-00	Rear Caliper 37.63024 '84-96 37.63025 '97-00	Sprocket Bolt Set 07.SBSM825 '86-00	Lower Chain Roller 33.0009 '83-00	Lower 26.450040 '83-85 26.310002 '91-97 26.450022 '98-00	Dust Seal Set 40.F3548D '86-91 40.F3648DP '98-00
Throttle Cable 53.112003 '87-00	Cover Gasket 19.G4198 '98-00	R/W Spacer Kit 26.710036 '98-00	Steering Bearing 24.110022 '86-00	Rear Caliper Rebuild Kit 37.63033 '91-00		Upper Chain Roller 33.0009 '83-00	Upper 26.310002 '98-00	Bushing Set 39.160058 '98-00
Water Pump Rebuild Kit 57.4118 '88-00	Clutch Cable 53.120056 '89-00			Front Master Cylinder Rebuild Kit 37.910001 '88-93 37.910002 '94-00				Rear Shock Seal Head Kit 26.810012 '86-00
				Rear Master Cylinder Rebuild Kit 37.910007 '91-00				
Air Filter 52.41091 '01-23	Basket 17.4198F * '01-23	Complete Plate Set 16.CPS41098 '01-23	F/W Bearing 23.S111081 '01-23	Frontbrake Disc 37.BD14101 '01-23	Front Sprocket 07.FS41086-12 07.FS41086-13 07.FS41086-14 07.FS41086-15 '01-23	Chain 07.RC420130C '01-23 MX	Swingarm 26.210067 '01-23	Seal & Wiper 40.S36488P '01-23
Main Jet 45.100-225 '01-23 Keihin	Clutch Rubber Set 17.CRS4198-6 '01-23	Friction Set 16.S41009 '01-23	R/W Bearing 23.S110033 '01-23	Rearbrake Disc 37.BD24101 '01-23	7075-T6 Alloy Rear Sprocket 07.RA41086-49 07.RA41086-50 07.RA41086-51 07.RA41086-52 07.RA41086-53 '01-23	Countershaft Seal Kit 26.640018 '01-04 26.640017 '05-23	Linkage 26.110014 '01-23	Oil Seal Set 40.F36488P '01-23
Pilot Jet 46.040-085 '01-23 Keihin	Spring Kit 17.CS41013 '01-23	Steel Set 16.S41010 '01-23	F/W Spacer Kit 26.710025 '01-23	Front Pad Set 37.106202 '01-23 37.106202BX '01-23 Box of 10		Lower Chain Roller 33.0012 '01-23	Upper 26.310002 '01-23	Dust Seal Set 40.F3648DP '01-23
Carburetor Rebuild Kit 55.10396 '01-13 55.10397 '14-21	Cover Gasket 19.G4198 '01-23		R/W Spacer Kit 26.710036 '01-23	Rear Pad Set 37.200802 '01-23 37.200802BX '01-23 Box of 10	Sprocket Bolt Set 07.SBSM825 '01-23		Lower 26.450022 '01-23	Bushing Set 39.160058 '01-18
Throttle Cable 53.112003 '01-13 53.112052 '14-23	Clutch Cable 53.121036 '14-23		Steering Bearing 24.110022 '01-23	Rear Caliper Rebuild Kit 37.63025 '01-23		Upper Chain Roller 33.0012 '01-23		Rear Shock Seal Head Kit 26.810012 '01-16 26.810002 '17-20
Water Pump Rebuild Kit 57.4118 '01-23				Rear Caliper Rebuild Kit 37.63033 '01-23				
				Front Master Cylinder Rebuild Kit 37.910002 '01-23				
				Rear Master Cylinder Rebuild Kit 37.910007 '01-23				

**DIRT**  
APRILIA  
BETA  
BMW  
GAS GAS  
HONDA  
HUSABERG  
HUSQVARNA  
KAWASAKI  
KTM  
MOTO TM  
RIEJU  
SHERCO  
SUZUKI  
YAMAHA

**STREET**  
APRILIA  
CAGIVA  
HONDA  
KAWASAKI  
KTM  
SUZUKI  
YAMAHA

**ATV-UTV**  
CAN-AM  
GAS GAS  
HONDA  
KAWASAKI  
KTM  
POLARIS  
SUZUKI  
YAMAHA

**PWC**  
KAWASAKI  
POLARIS  
SEA DOO  
YAMAHA

**SNOW**  
ARCTIC CAT  
KAWASAKI  
LYNX  
MOTO-SKI  
POLARIS  
SKI DOO  
YAMAHA

**MOPED & SCOOTER**

**MISC. TECH. SPECIAL**





### KAWASAKI

**DIRT**  
APRILIA  
BETA  
BMW  
GAS GAS  
HONDA  
HUSABERG  
HUSQVARNA  
KAWASAKI  
KTM  
MOTO TM  
RIEJU  
SHERCO  
SUZUKI  
YAMAHA

KX 100 2-Stroke Please Note: Nikasil Piston Size	<b>Piston Kit</b> 01.4195.A 01.4195.B 01.4195.C '95-13	<b>Size</b> 52.45 52.46 52.47	<b>Ring Set</b> 02.4195 02.4195 02.4195 '95-13	<b>CrankBearing &amp; Seal Kit</b> 23.CBS41088 '98-21	<b>Con. Rod Kit</b> 03.4118 '98-21	<b>Complete</b> 34.4125 '14-21		
Please Note: Nikasil Piston Size	01.4194.A 01.4194.B 01.4194.C '14-21	52.45 52.46 52.47	02.4194 02.4194 02.4194 '14-21	<b>Bearing</b> 23.6304C3 '98-21 2x	<b>S/E Bearing</b> 21.4103 '98-21	<b>Top-End</b> 35.4198 '98-13 35.4125 '14-21	<b>Head &amp; Base</b> 36.4198 '98-13 36.4214 '14-21	
				<b>Oilseal Set</b> 42.4105 '98-21	<b>B/E Bearing</b> 22.222916F '98-21	<b>Ignition Cover Gasket</b> 19.G94190 '95-05 19.G94107 '06-21		
					<b>Crankpin</b> 06.2246 '98-21			

**STREET**  
APRILIA  
CAGIVA  
HONDA  
KAWASAKI  
KTM  
SUZUKI  
YAMAHA

KX 112 2-Stroke Please Note: Nikasil Piston Size	<b>Piston Kit</b> 01.4194.A 01.4194.B 01.4194.C '22-23	<b>Size</b> 52.45 52.46 52.47	<b>Ring Set</b> 02.4194 02.4194 02.4194 '22-23	<b>CrankBearing &amp; Seal Kit</b> 23.CBS41088 '22-23	<b>S/E Bearing</b> 21.4103 '22-23	<b>Complete</b> 34.4125 '22		
				<b>Bearing</b> 23.6304C3 '22-23 2x		<b>Top-End</b> 35.4125 '22-23	<b>Head &amp; Base</b> 36.4214 '22-23	
				<b>Oilseal Set</b> 42.4105 '22-23				

**PWC**  
KAWASAKI  
POLARIS  
SEA DOO  
YAMAHA

**SNOW**  
ARCTIC CAT  
KAWASAKI  
LYNX  
MOTO-SKI  
POLARIS  
SKI DOO  
YAMAHA

**MOPED & SCOOTER**

**MISC. TECH. SPECIAL**

Footnotes: \* Bearings Only \*\* Rubbers included

**DIRT**  
APRILIA  
BETA  
BMW  
GAS GAS  
HONDA  
HUSABERG  
HUSQVARNA  
KAWASAKI  
KTM  
MOTO TM  
RIEJU  
SHERCO  
SUZUKI  
YAMAHA

**STREET**  
APRILIA  
CAGIVA  
HONDA  
KAWASAKI  
KTM  
SUZUKI  
YAMAHA

**ATV-UTV**  
CAN-AM  
GAS GAS  
HONDA  
KAWASAKI  
KTM  
POLARIS  
SUZUKI  
YAMAHA

**PWC**  
KAWASAKI  
POLARIS  
SEA DOO  
YAMAHA

**SNOW**  
ARCTIC CAT  
KAWASAKI  
LYNX  
MOTO-SKI  
POLARIS  
SKI DOO  
YAMAHA

**MOPED & SCOOTER**

**MISC. TECH. SPECIAL**

<b>Air Filter</b> 52.41091 '95-21	<b>Basket</b> 17.4198F * '98-21	<b>Complete Plate Set</b> 16.CPS41098 '98-21	<b>F/W Bearing</b> 23.S111077 '95-97 23.S111081 '98-21	<b>Frontbrake Disc</b> 37.BD14101 '06-21	<b>Front Sprocket</b> 07.FS41086-12 07.FS41086-13 07.FS41086-14 07.FS41086-15 '95-21	<b>Chain</b> 07.RC420130C '95-21 MX	<b>Swingarm</b> 26.210067 '95-21	<b>Seal &amp; Wiper</b> 40.S36488P '98-21
<b>Main Jet</b> 45.100-225 '98-21 Keihin	<b>Clutch Rubber Set</b> 17.CRS4198-6 '98-21	<b>Friction Set</b> 16.S41009 '98-21	<b>R/W Bearing</b> 23.S111071 '95-97 23.S110033 '98-21	<b>Rearbrake Disc</b> 37.BD24101 '01-21	<b>7075-T6 Alloy Rear Sprocket</b> 07.RA41086-49 07.RA41086-50 07.RA41086-51 07.RA41086-52 07.RA41086-53 '95-21	<b>Countershaft Seal Kit</b> 26.640018 '95-04 26.640017 '05-21	<b>Linkage</b> 26.110013 '95-97 26.110014 '98-21	<b>Oil Seal Set</b> 40.F36488P '98-21
<b>Pilot Jet</b> 46.040-085 '98-21 Keihin	<b>Spring Kit</b> 17.CS41013 '98-21	<b>Steel Set</b> 16.S41010 '98-21	<b>F/W Spacer Kit</b> 26.710025 '97-21	<b>Front Pad Set</b> 37.106202 '95-21 37.106202BX '95-21 Box of 10	<b>Rear Sprocket Bolt Set</b> 07.SBSM825 '95-21	<b>Lower Chain Roller</b> 33.0009 '95-00 33.0012 '01-21	<b>Upper</b> 26.310002 '98-21	<b>Dust Seal Set</b> 40.F3648DP '98-21
<b>Carburetor Rebuild Kit</b> 55.10401 '01-13 55.10402 '14-21	<b>Cover Gasket</b> 19.G4198 '98-21		<b>R/W Spacer Kit</b> 26.710036 '97-21	<b>Rear Pad Set</b> 37.200802 '95-21 37.200802BX '95-21 Box of 10		<b>Upper Chain Roller</b> 33.0009 '95-00 33.0012 '01-21	<b>Lower</b> 26.310002 '95-97 26.450022 '98-21	<b>Bushing Set</b> 39.160058 '95-19
<b>Throttle Cable</b> 53.112003 '95-13 53.112052 '14-21	<b>Clutch Cable</b> 53.120056 '95-13 53.121036 '14-21		<b>Steering Bearing</b> 24.110022 '95-21	<b>Front Caliper Rebuild Kit</b> 37.63025 '97-21			<b>Rear Shock Seal Head Kit</b> 26.810012 '95-20	
<b>Water Pump Rebuild Kit</b> 57.4118 '95-21				<b>Rear Caliper Rebuild Kit</b> 37.63033 '97-21				
				<b>Front Master Cylinder Rebuild Kit</b> 37.910002 '95-21				
				<b>Rear Master Cylinder Rebuild Kit</b> 37.910007 '95-21				

<b>Air Filter</b> 52.41091 '22-23	<b>Basket</b> 17.4198F * '22-23	<b>Complete Plate Set</b> 16.CPS41098 '22-23	<b>F/W Bearing</b> 23.S111081 '22-23	<b>Frontbrake Disc</b> 37.BD14101 '22-23	<b>Front Sprocket</b> 07.FS41086-12 07.FS41086-13 07.FS41086-14 07.FS41086-15 '22-23	<b>Chain</b> 07.RC420130C '22-23 MX	<b>Swingarm</b> 26.210067 '22-23	<b>Seal &amp; Wiper</b> 40.S36488P '22-23
<b>Main Jet</b> 45.100-225 '22-23 Keihin	<b>Clutch Rubber Set</b> 17.CRS4198-6 '22-23	<b>Friction Set</b> 16.S41009 '22-23	<b>R/W Bearing</b> 23.S110033 '22-23	<b>Rearbrake Disc</b> 37.BD24101 '22-23	<b>7075-T6 Alloy Rear Sprocket</b> 07.RA41086-49 07.RA41086-50 07.RA41086-51 07.RA41086-52 07.RA41086-53 '22-23	<b>Countershaft Seal Kit</b> 26.640017 '22-23	<b>Linkage</b> 26.110014 '22-23	<b>Oil Seal Set</b> 40.F36488P '22-23
<b>Pilot Jet</b> 46.040-085 '22-23 Keihin	<b>Spring Kit</b> 17.CS41013 '22-23	<b>Steel Set</b> 16.S41010 '22-23	<b>F/W Spacer Kit</b> 26.710025 '22-23	<b>Front Pad Set</b> 37.106202 '22-23 37.106202BX '22-23 Box of 10	<b>Rear Sprocket Bolt Set</b> 07.SBSM825 '22-23	<b>Lower Chain Roller</b> 33.0012 '22-23	<b>Upper</b> 26.310002 '22-23	<b>Dust Seal Set</b> 40.F3648DP '22-23
<b>Throttle Cable</b> 53.112052 '22-23	<b>Cover Gasket</b> 19.G4198 '22-23		<b>R/W Spacer Kit</b> 26.710036 '22-23	<b>Rear Pad Set</b> 37.200802 '22-23 37.200802BX '22-23 Box of 10		<b>Upper Chain Roller</b> 33.0012 '22-23	<b>Lower</b> 26.450022 '22-23	
<b>Water Pump Rebuild Kit</b> 57.4118 '22-23	<b>Clutch Cable</b> 53.121036 '22-23		<b>Steering Bearing</b> 24.110022 '22-23	<b>Front Caliper Rebuild Kit</b> 37.63025 '22-23				
				<b>Rear Caliper Rebuild Kit</b> 37.63033 '22-23				
				<b>Front Master Cylinder Rebuild Kit</b> 37.910002 '22-23				
				<b>Rear Master Cylinder Rebuild Kit</b> 37.910007 '22-23				

**PWC**  
KAWASAKI  
POLARIS  
SEA DOO  
YAMAHA

**SNOW**  
ARCTIC CAT  
KAWASAKI  
LYNX  
MOTO-SKI  
POLARIS  
SKI DOO  
YAMAHA

**MOPED & SCOOTER**

**MISC. TECH. SPECIAL**



### KAWASAKI

#### DIRT

APRILIA  
BETA  
BMW  
GAS GAS  
HONDA  
HUSABERG  
HUSQVARNA  
KAWASAKI  
KTM  
MOTO TM  
RIEJU  
SHERCO  
SUZUKI  
YAMAHA

KX 125 2-Stroke Please Note: Nikasil Piston Size	Piston Kit 01.4213.B 01.4213.C 01.4214.D '94	Size (mm) 53.95 53.96 53.97	Ring Set 02.4210 02.4210 02.4210 '94	Crank Bearing & Seal Kit 23.CBS42085 '85-87 23.CBS42088 '88-08	Con. Rod Kit 03.4285 '88-91 03.4214 '94-97 03.4218 '98-02 03.4223 '03-08	Complete 34.4215 '95-97 34.4218 '98-00 34.4221 '01-02 34.4223 '03-08				
Please Note: Nikasil Piston Size -Forged Piston	01.4216.A 01.4216.B 01.4216.C 01.4216.D '95-97	53.95 53.96 53.97 53.98	02.1222 02.1222 02.1222 02.1222 '95-97	<b>Bearing</b> 23.6305C3 '80-87 Left 23.6304C3 '82-84 Right 23.6322C3 '85-87 Right 23.6322C4 '88-08 2x	<b>S/E Bearing</b> 21.4204 '82-93 21.4214 '94-08	<b>Top-End</b> 35.4209 '89 35.4210 '90-91 35.4212 '92-94 35.4215 '95-97 35.4221 '98-02 35.4223 '03-08				
Please Note: Nikasil Piston Size	01.4218.A 01.4218.B 01.4218.C 01.4218.D '98-00	53.95 53.96 53.97 53.99	02.4217 02.4217 02.4217 02.4217 '98-00	<b>Oilseal Set</b> 42.4205 '85-87 42.4208 '88-08	<b>B/E Bearing</b> 22.222917F '78-87 22.222917 '88-91 22.222917F '92-08	<b>Head &amp; Base</b> 36.4200 '00-02 36.4203 '03-08				
Please Note: Nikasil Piston Size	01.4221.A 01.4221.B 01.4221.C '01-02	53.96 53.97 53.98	02.4217 02.4217 02.4217 '01-02		<b>Crankpin</b> 06.2251 '82-02	<b>Ignition Cover Gasket</b> 19.G94292 '92-02				
Please Note: Nikasil Piston Size	01.4223.A 01.4223.B 01.4223.C '03-08	53.95 53.96 53.97	02.4217 02.4217 02.4217 '03-08							
			<b>Pin</b> 04.1646.5 '82-91 04.1644.5 '92-93 04.1544.4 '98-08							
			<b>Clips</b> 05.1610 '82-87 05.1612C '88-93 05.1510 '94-08							

Footnotes: \* Bearings Only \*\* Rubbers included

#### DIRT

APRILIA  
BETA  
BMW  
GAS GAS  
HONDA  
HUSABERG  
HUSQVARNA  
KAWASAKI  
KTM  
MOTO TM  
RIEJU  
SHERCO  
SUZUKI  
YAMAHA

Air Filter 52.42097 '90-91 52.42092 '92-93 52.42097 '94-08	Basket 17.4290 * '90-92 17.4293 * '93 17.4294F * '94-02 17.4303F * '03-08	Complete Plate Set 16.CPS42094 '94-96 16.CPS42097 '97-02 16.CPS42003 '03-08	F/W Bearing 23.S110093 '85-92 23.S110079 '93-08	Frontbrake Disc 37.BD14206 '06-08	Front Sprocket 07.FS42094-12 12T 07.FS42094-13 07.FS42094-14 '94-08	Chain 07.RC520120C '80-08 MX 07.RC520120CG '80-08 MX Gold 07.RC520120XC '80-08 X-Ring 07.RC520120XCG '80-08 X-Ring Gold	Swingarm 26.210080 '83 26.210079 '85 26.210080 '86-91 26.210066 '92-93 26.210065 '94-95 26.210043 '96-97 26.210042 '98 26.210044 '99-08	Seal & Wiper 40.S435511 '83-87 40.S43559 '88 40.S43559 '91-95 40.S46589 '96-01 40.485810 '02-08
<b>Main Jet</b> 45.100-225 '96-00 Keihin 47.090-580 '01-08 Mikuni	<b>Clutch Rubber Set</b> 17.CRS4389-7 '90-93 17.CRS2288-8 '94-08	<b>Friction Set</b> 16.S42011 '85-87 16.S42013 '94-96 16.S42015 '97-08	<b>R/W Bearing</b> 23.S113045 '82 23.S111092 '85 23.S112023 '86-96 23.S112024 '97-02 23.S114006 '03-08	<b>Rearbrake Disc</b> 37.BD24203 '03-08	<b>7075-T6 Alloy Rear Sprocket</b> 07.RA42080-47 07.RA42080-48 07.RA42080-49 07.RA42080-50 07.RA42080-51 07.RA42080-52 '80-08	<b>Countershaft Seal Kit</b> 26.640016 '94-08	<b>Lower Chain Roller</b> 33.0002 '82-83 33.0001 '84-08	<b>Oil Seal Set</b> 40.F435511 '83-87 40.F43559 '88 40.F43559 '91-95 40.F46589 '96-01 40.F485810 '02-08
<b>Carburetor Rebuild Kit</b> 55.10558 '91 55.10557 '96-97 55.10409 '99 55.10556 '00 55.10410 '01 55.10509 '02 55.10502 '03-04 55.10503 '05	<b>Inner Hub</b> 18.4294 '94-02 18.4303 '03-08	<b>Steel Set</b> 16.S42012 '85-87 16.S42014 '94-08	<b>F/W Spacer Kit</b> 26.710028 '99-03 26.710029 '04-08	<b>Rear Pad Set</b> 37.105002 '87-88 37.105002BX '87-88 Box of 10 37.201202 37.201202BX '89-94 Box of 10 37.207102 '95-08 37.207102BX '95-08 Box of 10	<b>Ultralight Steel Rear Sprocket</b> 07.RS42080R-47 07.RS42080R-48 07.RS42080R-49 07.RS42080R-50 07.RS42080R-51 07.RS42080R-52 '80-08	<b>Upper Chain Roller</b> 33.0002 '82-83 33.0001 '84-08	<b>Dust Seal Set</b> 40.F4355DP '83-87 40.F4355DP '88 40.F4658D '89 40.F4355DP '91-95 40.F4658D '96-01 40.F4858D '02-08	
<b>Throttle Cable</b> 53.110015 '88-91 53.110036 '92-98 53.110035 '99-08	<b>Pressure Plate</b> 18.P4294 '94-02 18.P4303 '03-08		<b>R/W Spacer Kit</b> 26.710041 '97-02 26.710042 '03-08	<b>Front Caliper Rebuild Kit</b> 37.63024 '82 37.63010 '89-93 37.63005 '94-96 37.63011 '97-00 37.63005 '01-05	<b>Sprocket Bolt Set</b> 07.SBSM825 '80-08	<b>Upper</b> 26.310002 '89-08	<b>Bushing Set</b> 39.160048 '84-88 39.160071 '89 26.450041 '88 26.310002 '89-93 26.450022 '98-08	
<b>Water Pump Rebuild Kit</b> 57.4218 '88-91 57.4212 '92-94 57.4215 '95-02 57.4223 '03-05	<b>Spring Kit</b> 17.CS42014 '94-02 17.CS42015 '03-08		<b>Steering Bearing</b> 24.110004 '82-91 24.110023 '92-08	<b>Rear Caliper Rebuild Kit</b> 37.63024 '88 37.63031 '89-93 37.63004 '94 37.63028 '95-05		<b>Lower</b> 26.450040 '84-87 26.450041 '88 26.310002 '89-93 26.450022 '98-08		
	<b>Cover Gasket</b> 19.G4294 '94-02 19.G4203 '03-08			<b>Front Master Cylinder Rebuild Kit</b> 37.910001 '88-92 37.910002 '94-96 37.910010 '97-99 37.910002 '00-08		<b>Rear Shock Seal Head Kit</b> 26.810010 '83-86 26.810007 '87 26.810003 '88-92 26.810002 '93-99 26.810004 '00-08		
	<b>Clutch Cable</b> 53.120096 '88-93 53.121023 '94 53.120095 '95-96 53.120094 '97-98 53.120093 '99 53.120092 '00-02 53.120091 '03 53.120090 '04-05			<b>Rear Master Cylinder Rebuild Kit</b> 37.910007 '88-90 37.910003 '91-93 37.910007 '94-08				

#### STREET

APRILIA  
CAGIVA  
HONDA  
KAWASAKI  
KTM  
SUZUKI  
YAMAHA

#### ATV-UTV

CAN-AM  
GAS GAS  
HONDA  
KAWASAKI  
KTM  
POLARIS  
SUZUKI  
YAMAHA

#### PWC

KAWASAKI  
POLARIS  
SEA DOO  
YAMAHA

#### SNOW

ARCTIC CAT  
KAWASAKI  
LYNX  
MOTO-SKI  
POLARIS  
SKI DOO  
YAMAHA

#### MOPED & SCOOTER

#### MISC. TECH. SPECIAL





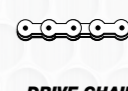

### KAWASAKI

<b>DIRT</b> APRILIA BETA BMW GAS GAS HONDA HUSABERG HUSQVARNA <b>KAWASAKI</b> KTM MOTO TM RIEJU SHERCO SUZUKI YAMAHA	KDX 220 R 2-Stroke	Piston Kit -	Size 69.00	Ring Set -	CrankBearing & Seal Kit 23.CBS42092 '98-05  Bearing 23.6305JR2 '98-05 2x  Oilseal Set 42.4288 '98-05	Con. Rod Kit 03.4285 '98-05  S/E Bearing 21.4204 '98-05  B/E Bearing 22.222917 '98-05  Crankpin 06.2251 '98-05	Complete 34.4287 '98-05  Top-End 35.4287 '98-05					
<b>STREET</b> APRILIA CAGIVA HONDA <b>KAWASAKI</b> KTM SUZUKI YAMAHA	KDX 250 E 2-Stroke Please Note: Nikasil Piston Size	Piston Kit 01.4306.B 01.4306.C 01.4306.D '92-95	Size 67.35 67.36 67.37	Ring Set 02.4305 02.4305 02.4305 '92-95  Clips 05.1810 '92-95		Con. Rod Kit 03.4309 '91-94  S/E Bearing 21.4305 '91-94  B/E Bearing 22.243220F '91-94  Crankpin 06.2458.5 '91-94						
<b>PWC</b> KAWASAKI POLARIS SEA DOO YAMAHA												
<b>SNOW</b> ARCTIC CAT <b>KAWASAKI</b> LYNX MOTO-SKI POLARIS SKI DOO YAMAHA												
<b>MOPED &amp; SCOOTER</b>												
<b>MISC. TECH. SPECIAL</b>												

Footnotes: \* Bearings Only \*\* Rubbers included

Air Filter 52.42089 '98-05  Main Jet 45.100-225 '98-05 Keihin  Pilot Jet 46.040-085 '98-05 Keihin  Throttle Cable 53.110039 '97-05  Water Pump Rebuild Kit 57.4315 '97-05	Spring Kit 17.CS42014 '97-05  Clutch Cable 53.120088 '97-05	Complete Plate Set 16.CPS43095 '98-05  Friction Set 16.S42016 '98-05  Steel Set 16.S42017 '98-05	F/W Bearing 23.S117045 '97-05  R/W Bearing 23.S112023 '98-05  Steering Bearing 24.110004 '98-05	Front Pad Set 37.103202 '97-05 37.103202BX '97-05 Box of 10  Rear Pad Set 37.201202 '97-05 37.201202BX '97-05 Box of 10  Front Caliper Rebuild Kit 37.63005 '95-05  Rear Caliper Rebuild Kit 37.63031 '95-05  Front Master Cylinder Rebuild Kit 37.910002 '98-05  Rear Master Cylinder Rebuild Kit 37.910007 '98-05	Front Sprocket 07.FS23080-13 07.FS23080-14 07.FS23080-15 '97-05  7075-T6 Alloy Rear Sprocket 07.RA42080-47 07.RA42080-48 07.RA42080-49 07.RA42080-50 07.RA42080-51 07.RA42080-52 '97-05  Ultralight Steel Rear Sprocket 07.RS42080R-47 07.RS42080R-48 07.RS42080R-49 07.RS42080R-50 07.RS42080R-51 07.RS42080R-52 '97-05  Sprocket Bolt Set 07.SBSM825 '97-05	Chain 07.RC520120C '97-05 MX 07.RC520120CG '97-05 MX Gold 07.RC520120XC '97-05 X-Ring 07.RC520120XCG '97-05 X-Ring Gold  Countershaft Seal Kit 26.640036 '97-05  Lower Chain Roller 33.0001 '97-05  Upper Chain Roller 33.0001 '97-05	Swingarm 26.210064 '98-05  Linkage 26.110036 '98-05  Lower 26.310002 '98-05	Seal & Wiper 40.S43559 '98-05  Oil Seal Set 40.F43559 '98-05  Dust Seal Set 40.F4355DP '98-05  Bushing Set 39.160063 '98-05  Rear Shock Seal Head Kit 26.810007 '97-05
Water Pump Rebuild Kit 57.4318 '91-94	Clutch Cable 53.120003 '91-94	Friction Set 16.S43018 '82-84 16.S43019 '91-94  Steel Set 16.S43020 '91-94	F/W Bearing 23.S117045 '92-94  R/W Bearing 23.S112023 '91-94  Steering Bearing 24.110004 '91-94	Front Pad Set 37.100202 '91-93 37.100202BX '91-93 Box of 10  Rear Pad Set 37.201202 '91-93 37.201202BX '91-93 Box of 10  Front Caliper Rebuild Kit 37.63010 '91-94  Rear Caliper Rebuild Kit 37.63031 '91-94  Front Master Cylinder Rebuild Kit 37.910001 '91-94  Rear Master Cylinder Rebuild Kit 37.910003 '91-94	Chain 07.RC520120C '80-94 MX 07.RC520120CG '80-94 MX Gold 07.RC520120XC '80-94 X-Ring 07.RC520120XCG '80-94 X-Ring Gold  Countershaft Seal Kit 26.640015 '91-94  Lower Chain Roller 33.0001 '91-94  Upper Chain Roller 33.0001 '91-94	Swingarm 26.210080 '91-94  Linkage 26.110040 '91-94  Lower 26.310002 '91-94	Oil Seal Set 40.F385011 '92-95  Bushing Set 39.160064 '91-94  Rear Shock Seal Head Kit 26.810007 '91-94	

<b>DIRT</b> APRILIA BETA BMW GAS GAS HONDA HUSABERG HUSQVARNA <b>KAWASAKI</b> KTM MOTO TM RIEJU SHERCO SUZUKI YAMAHA												
<b>STREET</b> APRILIA CAGIVA HONDA <b>KAWASAKI</b> KTM SUZUKI YAMAHA												
<b>ATV-UTV</b> CAN-AM GAS GAS HONDA <b>KAWASAKI</b> KTM POLARIS SUZUKI YAMAHA												
<b>PWC</b> KAWASAKI POLARIS SEA DOO YAMAHA												
<b>SNOW</b> ARCTIC CAT <b>KAWASAKI</b> LYNX MOTO-SKI POLARIS SKI DOO YAMAHA												
<b>MOPED &amp; SCOOTER</b>												
<b>MISC. TECH. SPECIAL</b>												



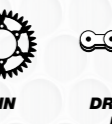

### KAWASAKI

**DIRT**  
APRILIA  
BETA  
BMW  
GAS GAS  
HONDA  
HUSABERG  
HUSQVARNA  
KAWASAKI  
KTM  
MOTO TM  
RIEJU  
SHERCO  
SUZUKI  
YAMAHA

**STREET**  
APRILIA  
CAGIVA  
HONDA  
KAWASAKI  
KTM  
SUZUKI  
YAMAHA

**ATV-UTV**  
CAN-AM  
GAS GAS  
HONDA  
KAWASAKI  
KTM  
POLARIS  
SUZUKI  
YAMAHA

**PWC**  
KAWASAKI  
POLARIS  
SEA DOO  
YAMAHA

**SNOW**  
ARCTIC CAT  
KAWASAKI  
LYNX  
MOTO-SKI  
POLARIS  
SKI DOO  
YAMAHA

**MOPED & SCOOTER**

**MISC. TECH. SPECIAL**

KX 250	Piston Kit	Size	Ring Set	Crank Bearing & Seal Kit	Con. Rod Kit	Complete
2-Stroke Please Note: Nikasil Piston Size	01.4306.B 01.4306.C 01.4306.D '90-91	67.35 67.36 67.37	02.4305 02.4305 02.4305 '90-91	23.CBS43087 '87-01 23.CBS43002 '02 23.CBS43003 '03-08	03.4309 '78-08  <b>S/E Bearing</b> 21.4305 '78-08  <b>B/E Bearing</b> 22.243220F '78-08	34.4313 '93-03 34.4314 '04 34.4315 '05-08  <b>Top-End</b> 35.4310 '88-91 35.4312 '92 35.4313 '93-03 35.4314 '04 35.4315 '05-08  <b>Head &amp; Base</b> 36.4393 '93-00 36.4301 '01-04 36.4305 '05-08  <b>Ignition Cover Gasket</b> 19.G94390 '90-04 19.G94305 '05-07
Please Note: Nikasil Piston Size -Molycoated Skirt	01.4322.B 01.4322.C 01.4322.D '92-04	66.35 66.36 66.37	02.4312 02.4312 02.4312 '92-04	23.6328C3 '87-01 2x 23.6328/72C4 '02 2x 23.SCO6C50C4 '03-08 2x		
Please Note: Nikasil Piston Size -Molycoated Skirt	01.4325.B 01.4325.C 01.4325.D '05-08	66.35 66.36 66.37	02.4325 02.4325 02.4325 '05-08			
			<b>Clips</b> 05.1810 '87-91 05.1812 '92-08	<b>Oilseal Set</b> 42.4300 '80-08		

Footnotes: \* Bearings Only \*\* Rubbers included

Air Filter	Basket	Complete Plate Set	F/W Bearing	Frontbrake Disc	Front Sprocket	Chain	Swingarm	Seal & Wiper
52.42097 '90-91 52.42092 '92-93 52.42097 '94-08	17.4389 * '90-91 17.4392F * '92-05	16.CPS43092 '92-08	23.S110093 '86-92 23.S110079 '93-08	37.BD14206 '06-08	07.FS23080-13 07.FS23080-14 07.FS23080-15 '87-98	07.RC520120C '79-08 MX 07.RC520120CG '79-08 MX Gold 07.RC520120XC '79-08 X-Ring 07.RC520120XCG '79-08 X-Ring Gold	26.210080 '86-91 26.210066 '92-93 26.210065 '94-95 26.210043 '96-97 26.210042 '98	40.S43559 '88 40.S41559 '90 40.S43559 '91-95 40.S46589 '96-97 40.S485810 '02-08
<b>Main Jet</b> 45.100-225 '95-08 Keihin	<b>Clutch Rubber Set</b> 17.CRS4389-8 '90-08	<b>Friction Set</b> 16.S43019 '87-91 16.S43023 '92-08	<b>R/W Bearing</b> 23.S112023 '86-96 23.S112024 '97-02 23.S114006 '03-08	<b>Rearbrake Disc</b> 37.BD24203 '03-08	<b>Front Pad Set</b> 37.100202 '89-93 37.100202BX '89-93 Box of 10 37.103202 '94-08	<b>7075-T6 Alloy Rear Sprocket</b> 07.RA42080-47 07.RA42080-48 07.RA42080-49 07.RA42080-50 07.RA42080-51 07.RA42080-52 '87-08	<b>Countershaft Seal Kit</b> 26.640015 '91-08	<b>Oil Seal Set</b> 40.F43559 '88 40.F43559 '91-95 40.F46589 '96-01 40.F485810 '02-08
<b>Pilot Jet</b> 46.040-085 '95-08 Keihin	<b>Inner Hub</b> 18.4392 '92-08	<b>Steel Set</b> 16.S43021 '87-90 16.S43020 '91 16.S43022 '92-08	<b>F/W Spacer Kit</b> 26.710028 '99-03 26.710029 '04-05 26.710031 '06-08	<b>Front Pad Set</b> 37.201202 '89-94 Box of 10 37.201202BX '94-08	<b>Rear Pad Set</b> 37.201202 '89-94 Box of 10 37.201202BX '95-08 Box of 10	<b>Ultraight Steel Rear Sprocket</b> 07.RS42080R-47 07.RS42080R-48 07.RS42080R-49 07.RS42080R-50 07.RS42080R-51 07.RS42080R-52 '87-08	<b>Upper Chain Roller</b> 33.0001 '84-08	<b>Dust Seal Set</b> 40.F4355DP '88 40.F4658D '89 40.F4355DP '91-95 40.F4658D '96-01 40.F4858D '02-08
<b>Carburetor Rebuild Kit</b> 55.10582 '93 55.10553 '94 55.10581 '95 55.10552 '96 55.10550 '97 55.10549 '98 55.10548 '99 55.10134 '00 55.10137 '01 55.10551 '02 55.10136 '03 55.10135 '04 55.10134 '05-07	<b>Pressure Plate</b> 18.P4392 '92-02 18.P4403 '03-08	<b>Cover Gasket</b> 19.G4392 '92-04 19.G4395 '05-08	<b>R/W Spacer Kit</b> 26.710041 '97-02 26.710042 '03-08	<b>Steering Bearing</b> 24.110004 '79-91 24.110023 '92-08	<b>Front Caliper Rebuild Kit</b> 37.63010 '89-93 37.63011 '94-96 37.63011 '97-00 37.63005 '01-07	<b>Sprocket Bolt Set</b> 07.SBSM825 '87-08	<b>Lower Chain Roller</b> 33.0001 '84-08	<b>Rear Shock Seal Head Kit</b> 26.810007 '87 26.810003 '88-92 26.810002 '93-99 26.810004 '00-08
<b>Throttle Cable</b> 53.110015 '84-91 53.110036 '92-98 53.110035 '99-04 53.110034 '05-08	<b>Clutch Cable</b> 53.120003 '90-98 53.120087 '99-04 53.120086 '05-08				<b>Rear Caliper Rebuild Kit</b> 37.63024 '88 37.63031 '89-93 37.63004 '94 37.63028 '95-07			
<b>Water Pump Rebuild Kit</b> 57.4318 '87-91 57.4312 '92-96 57.4317 '97-04 57.4325 '05-07					<b>Front Master Cylinder Rebuild Kit</b> 37.910001 '88-92 37.910002 '94-96 37.910010 '97-99 37.910002 '00-08			
					<b>Rear Master Cylinder Rebuild Kit</b> 37.910007 '88-90 37.910003 '91-93 37.910007 '94-08			

**DIRT**  
APRILIA  
BETA  
BMW  
GAS GAS  
HONDA  
HUSABERG  
HUSQVARNA  
KAWASAKI  
KTM  
MOTO TM  
RIEJU  
SHERCO  
SUZUKI  
YAMAHA

**STREET**  
APRILIA  
CAGIVA  
HONDA  
KAWASAKI  
KTM  
SUZUKI  
YAMAHA

**ATV-UTV**  
CAN-AM  
GAS GAS  
HONDA  
KAWASAKI  
KTM  
POLARIS  
SUZUKI  
YAMAHA

**PWC**  
KAWASAKI  
POLARIS  
SEA DOO  
YAMAHA

**SNOW**  
ARCTIC CAT  
KAWASAKI  
LYNX  
MOTO-SKI  
POLARIS  
SKI DOO  
YAMAHA

**MOPED & SCOOTER**

**MISC. TECH. SPECIAL**







### KAWASAKI

**DIRT**  
APRILIA  
BETA  
BMW  
GAS GAS  
HONDA  
HUSABERG  
HUSQVARNA  
KAWASAKI  
KTM  
MOTO TM  
RIEJU  
SHERCO  
SUZUKI  
YAMAHA

Model	Piston Kit	Size (mm)	Ring Set	Crank Bearing & Seal Kit	Con. Rod Kit	Top-End	Cam Chain	Valve
KX 250 X 4-Stroke Please Note: Nikasil Piston Size -Std. Compression 14.1:1 -Forged Piston -Fuel Injection	01.4351.A 01.4351.B 01.4351.C '21-22	77.96 77.97 77.98	02.4351 02.4351 02.4351 '21-23	23.CBS43051 '21-23	03.4351 '21-23	35.4351 '21-23	31.4351 '21-23	28.4350-1 '21-23 2x Exhaust Titanium 28.4350-2 '21-22 2x Intake Titanium
	01.4353.A 01.4353.B 01.4353.C '23	77.96 77.97 77.98	02.4351 02.4351 02.4351 '21-23	Bearing 23.6206RSI '21-23 2x	Crankpin 06.3055.9 '21-23	Head & Base 36.4351 '21-23	Valve Shim Assortment 29.VSA948 '21-23 29.VSA948-2 '21-23	Valve Seal 35.VS021 '21-23 4x
			Clips 05.1610 '21-23	Oilseal Set 42.4351 '21-23				

**STREET**  
APRILIA  
CAGIVA  
HONDA  
KAWASAKI  
KTM  
SUZUKI  
YAMAHA

Model	Piston Kit	Size	Ring Set	Crank Bearing & Seal Kit	Con. Rod Kit	Complete	Cam Chain	Valve
KLX 400 R 4-Stroke Please Note: Nikasil Piston Size -Std. Compression 12.2:1 -Forged Piston	01.3420.A 01.3420.B 01.3420.C '03	89.96 89.97 89.98	02.3402 02.3402 02.3402 '03	23.CBS34000* '03	03.3402 '03	34.3420 '03	31.3403 '03	28.3402-1 '03 2x Exhaust Steel 28.3402-2 '03 2x Intake Steel
			Clips 05.2012 '03	Bearing 23.6306R/3 '03 2x	B/E Bearing 22.354322F '03	Top-End 35.3420 '03	Valve Shim Assortment 29.VSA948 '03 29.VSA948-2 '03	
						Ignition Cover Gasket 19.G93400 '03		

**PWC**  
KAWASAKI  
POLARIS  
SEA DOO  
YAMAHA

Model	Piston Kit	Size	Ring Set	Crank Bearing & Seal Kit	Con. Rod Kit	Complete	Cam Chain	Valve

**SNOW**  
ARCTIC CAT  
KAWASAKI  
LYNX  
MOTO-SKI  
POLARIS  
SKI DOO  
YAMAHA

Model	Piston Kit	Size	Ring Set	Crank Bearing & Seal Kit	Con. Rod Kit	Complete	Cam Chain	Valve

**MOPED & SCOOTER**

Model	Piston Kit	Size	Ring Set	Crank Bearing & Seal Kit	Con. Rod Kit	Complete	Cam Chain	Valve

**MISC. TECH. SPECIAL**

Footnotes: \* Bearings Only \*\* Rubbers included

**DIRT**  
APRILIA  
BETA  
BMW  
GAS GAS  
HONDA  
HUSABERG  
HUSQVARNA  
KAWASAKI  
KTM  
MOTO TM  
RIEJU  
SHERCO  
SUZUKI  
YAMAHA

**STREET**  
APRILIA  
CAGIVA  
HONDA  
KAWASAKI  
KTM  
SUZUKI  
YAMAHA

**ATV-UTV**  
CAN-AM  
GAS GAS  
HONDA  
KAWASAKI  
KTM  
POLARIS  
SUZUKI  
YAMAHA

**PWC**  
KAWASAKI  
POLARIS  
SEA DOO  
YAMAHA

**SNOW**  
ARCTIC CAT  
KAWASAKI  
LYNX  
MOTO-SKI  
POLARIS  
SKI DOO  
YAMAHA

**MOPED & SCOOTER**

**MISC. TECH. SPECIAL**

Model	Air Filter	Basket	Complete Plate Set	F/W Bearing	Frontbrake Disc	Front Sprocket	Chain	Swingarm	Seal & Wiper
	52.44019 '21-23	17.4336F * '21-23	16.CPS43021 '21-23	23.S114082 '21-23	37.BD14315 '21-23	07.FS43006-13 07.FS43006-14 07.FS43006-15 '21-23	07.RC520120C '21-23 MX 07.RC520120CG '21-23 MX Gold 07.RC520120XC '21-23 X-Ring 07.RC520120XCG '21-23 X-Ring Gold	26.210217 '21-23	40.S485810 '21-23
	Oil Filter 54.43207 '21-23 1-Pce. 54.43207-50 '21-23 50-Pcs.	Inner Hub 18.4351 '21-23	Friction Set 16.S43041 '21-23	R/W Bearing 23.S114006 '21-23	Rearbrake Disc 37.BD24203 '21-23	7075-T6 Alloy Rear Sprocket 07.RA42080-47 07.RA42080-48 07.RA42080-49 07.RA42080-50 07.RA42080-51 07.RA42080-52 '21-23	Lower Chain Roller 33.0014 '21-23	Upper 26.310002 '21-23	Oil Seal Set 40.F485810 '21-23
	Throttle Cable 53.112066 '21-23	Clutch Rubber Set 17.CRS4336-8 '21-23	Steel Set 16.S43042 '21-23	F/W Spacer Kit 26.710108 '21-23	Front Pad Set 37.103202 '21-23 37.103202BX '21-23 Box of 10	7075-T6 Alloy Rear Sprocket 07.RA42080-47 07.RA42080-48 07.RA42080-49 07.RA42080-50 07.RA42080-51 07.RA42080-52 '21-23	Lower Chain Roller 33.0014 '21-23	Lower 26.450022 '21-23	Dust Seal Set 40.F4858D '21-23
		Master Cylinder Rebuild Kit 16.940014 '21		R/W Spacer Kit 26.710042 '21-23	Rear Pad Set 37.201302 '21-23 37.201302BX '21-23 Box of 10	Ultralight Steel Rear Sprocket 07.RS42080R-47 07.RS42080R-48 07.RS42080R-49 07.RS42080R-50 07.RS42080R-51 07.RS42080R-52 '21-23	Upper Chain Roller 33.0014 '21-23		
		Slave Cylinder Rebuild Kit 16.950016 '21		Steering Bearing 24.110023 '21-23	Front Caliper Rebuild Kit 37.63005 '21-23	Sprocket Bolt Set 07.SBSM825 '21-23			
					Rear Caliper Rebuild Kit 37.63032 '21-23				
					Rear Master Cylinder Rebuild Kit 37.910007 '21-23				

Model	Main Jet	Basket	Complete Plate Set	F/W Bearing	Frontbrake Disc	Front Sprocket	Chain	Swingarm	Seal & Wiper
	45.100-225 '03 Keihin	17.3400F '03	16.CPS34000 '03	23.S110079 '03	37.BD13288 '03	07.FS33082-13 07.FS33082-14 07.FS33082-15 '03	07.RC520120C '03 MX 07.RC520120CG '03 MX Gold 07.RC520120XC '03 X-Ring 07.RC520120XCG '03 X-Ring Gold	26.210047 '03	40.S496011 '03
	Pilot Jet 46.040-085 '03 Keihin	Pressure Plate 18.P3402 '03	Friction Set 16.S34015 '03	R/W Bearing 23.111017 '03	Front Pad Set 37.103202 '03 37.103202BX '03 Box of 10	7075-T6 Alloy Rear Sprocket 07.RA32080-48 07.RA32080-49 07.RA32080-50 07.RA32080-51 07.RA32080-52 '03	Lower Chain Roller 33.0001 '03	Linkage 26.110043 '03	Oil Seal Set 40.F496011 '03
	Throttle Cable 53.111083 '03	Spring Kit 17.CS44019 '03	Steel Set 16.S34016 '03	Steering Bearing 24.110013 '03	Rear Pad Set 37.207102 '03 37.207102BX '03 Box of 10	Ultralight Steel Rear Sprocket 07.RS32080R-48 07.RS32080R-49 07.RS32080R-50 07.RS32080R-51 07.RS32080R-52 '03	Lower Chain Roller 33.0002 '03	Lower 26.450024 '03	Dust Seal Set 40.F4960D '03
	Oil Filter 54.34139 '03 1-Pce. 54.34139-50 '03 50-Pcs.	Cover Gasket 19.G3401 '03			Front Caliper Rebuild Kit 37.63005 '03		Upper Chain Roller 33.0002 '03		Bushing Set 39.160037 '03
	Water Pump Rebuild Kit 57.3420 '03-04	Clutch Cable 53.120042 '03			Rear Caliper Rebuild Kit 37.63028 '03	Sprocket Bolt Set 07.SBSM825 '03			Rear Shock Seal Head Kit 26.810001 '03

**PWC**  
KAWASAKI  
POLARIS  
SEA DOO  
YAMAHA

**SNOW**  
ARCTIC CAT  
KAWASAKI  
LYNX  
MOTO-SKI  
POLARIS  
SKI DOO  
YAMAHA

**MOPED & SCOOTER**

**MISC. TECH. SPECIAL**



KAWASAKI

DIRT

STREET

ATV-UTV

PWC

SNOW

MOPED & SCOOTER

MISC. TECH. SPECIAL

Table with columns for model (KX 450 F, KX 450 X), part categories (Piston Kit, Con. Rod Kit, Complete, Cam Chain, Valve, etc.), and part numbers. Includes footnotes: \* Bearings Only \*\* Rubbers included

Table with columns for part categories (Air Filter, Basket, Complete Plate Set, F/W Bearing, Frontbrake Disc, etc.) and part numbers.

DIRT

STREET

ATV-UTV

PWC

SNOW

MOPED & SCOOTER

MISC. TECH. SPECIAL







### KAWASAKI

#### DIRT

- APRILIA
- BETA
- BMW
- GAS GAS
- HONDA
- HUSABERG
- HUSQVARNA
- KAWASAKI
- KTM
- MOTO TM
- RIEJU
- SHERCO
- SUZUKI
- YAMAHA

KLX 450 R 4-Stroke Please Note: Nikasil Piston Size -Std. Compression 12.0:1 -Forged Piston	<b>Piston Kit</b> 01.4406.A 01.4406.B 01.4406.C '08-21	<b>Size</b> 95.97 95.98 95.99	<b>Ring Set</b> 02.1402 02.1402 02.1402 '08-21	<b>Pin</b> 04.1950.3 '08-21	<b>Clips</b> 05.1912 '08-21	<b>Con. Rod Kit</b> 03.4406 '08-21	<b>B/E Bearing</b> 22.344220F '08-21	<b>Complete</b> 34.4418 '08-18	<b>Top-End</b> 35.4406 '08-21	<b>Head &amp; Base</b> 36.4406 '08-21	<b>Ignition Cover Gasket</b> 19.G94406 '08-21	<b>Cam Chain</b> 31.4406 '08-21	<b>Valve Shim Assortment</b> 29.VSA948 '08-21	<b>Valve Seal</b> 35.VS022 '08-21 2x Intake 35.VS022 '08-21 2x Exhaust
--	--	--	--	-----------------------------------	-----------------------------------	--	--	--------------------------------------	-------------------------------------	---	---	---------------------------------------	---	--

#### STREET

- APRILIA
- CAGIVA
- HONDA
- KAWASAKI
- KTM
- SUZUKI
- YAMAHA

KX 500 2-Stroke Please Note: Nikasil Piston Size	<b>Piston Kit</b> 01.4408.A 01.4408.B '88-04	<b>Size</b> 85.94 85.95	<b>Ring Set</b> 02.4408 02.4408 '88-04	<b>CrankBearing &amp; Seal Kit</b> 23.CBS45088 '83-04	<b>Bearing</b> 23.6306C3 '83-04 2x	<b>Oilseal Set</b> 42.4403 '83-04	<b>S/E Bearing</b> 21.4408 '85-04	<b>B/E Bearing</b> 22.263322F '85-04	<b>Complete</b> 34.4409 '89-04	<b>Top-End</b> 35.4409 '89-04	<b>Ignition Cover Gasket</b> 19.G94586 '86-04			
---	---	-------------------------------	---	---	--	---	---	--	--------------------------------------	-------------------------------------	---	--	--	--

#### PWC

- KAWASAKI
- POLARIS
- SEA DOO
- YAMAHA

#### SNOW

- ARCTIC CAT
- KAWASAKI
- LYNX
- MOTO-SKI
- POLARIS
- SKI DOO
- YAMAHA

#### MOPED & SCOOTER

#### MISC. TECH. SPECIAL

Footnotes: \* Bearings Only \*\* Rubbers included

<b>Air Filter</b> 52.44008 '08-21	<b>Main Jet</b> 45.100-225 '08-21 Keihin	<b>Pilot Jet</b> 46.040-085 '08-21 Keihin	<b>Throttle Cable</b> 53.110032 '08-21	<b>Oil Filter</b> 54.44113 '08-21 1-Pce. 54.44113-50 '08-21 50-Pcs.	<b>Water Pump Rebuild Kit</b> 57.4426 '08-21	<b>Basket</b> 17.4406F * '08-21	<b>Clutch Rubber Set</b> 17.CRS4389-8 '08-21	<b>Inner Hub</b> 18.4406 '08-21	<b>Pressure Plate</b> 18.P4406 '08-21	<b>Spring Kit</b> 17.CS44020 '08-21	<b>Cover Gasket</b> 19.G4406 '08-21	<b>Clutch Cable</b> 53.120082 '08-21	<b>Complete Plate Set</b> 16.CPS44010 '08-21	<b>Friction Set</b> 16.S14015 '08-21	<b>Steel Set</b> 16.S34016 '08-21	<b>F/W Bearing</b> 23.S110079 '08-21	<b>R/W Bearing</b> 23.S114006 '08-21	<b>R/W Spacer Kit</b> 26.710042 '08-21	<b>Steering Bearing</b> 24.110023 '08-21	<b>Frontbrake Disc</b> 37.BD14206 '08-21	<b>Rearbrake Disc</b> 37.BD24203 '08-21	<b>Front Pad Set</b> 37.103202 '08-21	<b>Rear Pad Set</b> 37.103202BX '08-21 Box of 10	<b>Front Caliper Rebuild Kit</b> 37.63005 '08-21	<b>Rear Caliper Rebuild Kit</b> 37.63032 '08-21	<b>Front Master Cylinder Rebuild Kit</b> 37.910002 '08-21	<b>Rear Master Cylinder Rebuild Kit</b> 37.910007 '08-21	<b>Front Sprocket</b> 07.FS44006-13 07.FS44006-14 07.FS44006-15 '08-21	<b>7075-T6 Alloy Rear Sprocket</b> 07.RA42080-47 07.RA42080-48 07.RA42080-49 07.RA42080-50 07.RA42080-51 07.RA42080-52 '08-21	<b>Chain</b> 07.RC520120C '08-21 MX 07.RC520120CG '08-21 MX Gold 07.RC520120XCG '08-21 X-Ring 07.RC520120XCG '08-21 X-Ring Gold	<b>Countershaft Seal Kit</b> 26.640011 '08-21	<b>Lower Chain Roller</b> 33.0014 '08-21	<b>Upper Chain Roller</b> 33.0014 '08-21	<b>Sprocket Bolt Set</b> 07.SBSM825 '08-21	<b>Swingarm</b> 26.210156 '08-21	<b>Linkage</b> 26.110137 '08-21	<b>Upper</b> 26.310002 '08-21	<b>Lower</b> 26.450022 '08-21	<b>Seal &amp; Wiper</b> 40.S485810 '08-21	<b>Oil Seal Set</b> 40.F485810 '08-21	<b>Dust Seal Set</b> 40.F4858D '08-21	<b>Bushing Set</b> 39.160068 '08-21	<b>Rear Shock Seal Head Kit</b> 26.810004 '08-21
<b>Air Filter</b> 52.45087 '87-04	<b>Main Jet</b> 45.100-225 '88-04 Keihin	<b>Pilot Jet</b> 46.040-085 '88-04 Keihin	<b>Throttle Cable</b> 53.110015 '84-04	<b>Carburetor Rebuild Kit</b> 55.10102 '96-04		<b>Basket</b> 17.4389 * '86-04	<b>Clutch Rubber Set</b> 17.CRS4389-8 '86-04	<b>Inner Hub</b> 18.4408 '89-04	<b>Spring Kit</b> 17.CS44018 '87-04	<b>Cover Gasket</b> 19.G4489 '89-04	<b>Clutch Cable</b> 53.120003 '90-04	<b>Friction Set</b> 16.S43019 '87-04	<b>Steel Set</b> 16.S43021 '87	<b>F/W Bearing</b> 23.S110093 '85-93 23.S110079 '95-04	<b>R/W Bearing</b> 23.S112023 '86-93 23.S112024 '94-04	<b>R/W Spacer Kit</b> 26.710041 '97-04	<b>Steering Bearing</b> 24.110004 '83-04	<b>Front Pad Set</b> 37.100202 '89-93 37.100202BX '89-93 Box of 10 37.103202 '94-04	<b>Rear Pad Set</b> 37.201202 '89-95 37.201202BX '89-95 Box of 10 37.207102 '96-04	<b>Front Caliper Rebuild Kit</b> 37.63010 '89-93 37.63005 '94-04	<b>Rear Caliper Rebuild Kit</b> 37.63024 '88 37.63031 '89-93 37.63004 '94-95 37.63028 '96-04	<b>Front Master Cylinder Rebuild Kit</b> 37.910001 '85-93 37.910002 '94-04	<b>Rear Master Cylinder Rebuild Kit</b> 37.910007 '88-90 37.910003 '91-93 37.910007 '94-04	<b>Front Sprocket</b> 07.FS23080-13 07.FS23080-14 07.FS23080-15 '87-04	<b>7075-T6 Alloy Rear Sprocket</b> 07.RA42080-47 07.RA42080-48 07.RA42080-49 07.RA42080-50 07.RA42080-51 07.RA42080-52 '83-04	<b>Chain</b> 07.RC520120C '83-04 MX 07.RC520120CG '83-04 MX Gold 07.RC520120XC '83-04 X-Ring 07.RC520120XCG '83-04 X-Ring Gold	<b>Lower Chain Roller</b> 33.0001 '84-04	<b>Upper Chain Roller</b> 33.0001 '84-04	<b>Sprocket Bolt Set</b> 07.SBSM825 '83-04	<b>Swingarm</b> 26.210080 '86-04	<b>Linkage</b> 26.110108 '88	<b>Upper</b> 26.110040 '89-04	<b>Lower</b> 26.310002 '89-04	<b>Seal &amp; Wiper</b> 40.S43559 '88+91-95 40.S46589 '96-04	<b>Oil Seal Set</b> 40.F43559 '88+91-95 40.F46589 '96-04	<b>Dust Seal Set</b> 40.F4355DP '88+91-95 40.F4658D '89	<b>Bushing Set</b> 39.160048 '83-88 39.160071 '89 39.160070 '90 39.160069 '91-96 39.160010 '97-04	<b>Rear Shock Seal Head Kit</b> 26.810010 '83-85 26.810002 '86 26.810007 '87 26.810003 '88-93 26.810002 '94-04					

#### DIRT

- APRILIA
- BETA
- BMW
- GAS GAS
- HONDA
- HUSABERG
- HUSQVARNA
- KAWASAKI
- KTM
- MOTO TM
- RIEJU
- SHERCO
- SUZUKI
- YAMAHA

#### STREET

- APRILIA
- CAGIVA
- HONDA
- KAWASAKI
- KTM
- SUZUKI
- YAMAHA

#### ATV-UTV

- CAN-AM
- GAS GAS
- HONDA
- KAWASAKI
- KTM
- POLARIS
- SUZUKI
- YAMAHA

#### PWC

- KAWASAKI
- POLARIS
- SEA DOO
- YAMAHA

#### SNOW

- ARCTIC CAT
- KAWASAKI
- LYNX
- MOTO-SKI
- POLARIS
- SKI DOO
- YAMAHA

#### MOPED & SCOOTER

#### MISC. TECH. SPECIAL





### KTM

<b>DIRT</b> KTM MOTO TM RIEJU SHERCO SUZUKI YAMAHA	KTM 50 Adventure 2-Stroke Please Note: Nikasil Piston Size -Molycoated Skirt	<b>Piston Kit</b> 01.6012.A 01.6012.B 01.6012.C '02-08	<b>SIZES (mm)</b> 39.46 39.47 39.48	<b>Ring Set</b> 02.6012 02.6012 02.6012 '02-08	<b>Bearing</b> 23.6203T9C3 '02-08 2x	<b>S/E Bearing</b> 21.7012 '02-08	<b>Complete</b> 34.6011 '02-08									
	KTM 50 SX 2-Stroke Please Note: Nikasil Piston Size -Molycoated Skirt	<b>Piston Kit</b> 01.6012.A 01.6012.B 01.6012.C '01-08	<b>Size</b> 39.46 39.47 39.48	<b>Ring Set</b> 02.6012 02.6012 02.6012 '01-08	<b>CrankBearing &amp; Seal Kit</b> 23.CBS60001 '01-08 23.CBS60009 '09-12 23.CBS60013 '13-23	<b>Con. Rod Kit</b> 03.6011 '01-23	<b>S/E Bearing</b> 21.6011 '01-23	<b>Complete</b> 34.6011 '01-08 34.6012 '09-22	<b>Clips</b> 05.1210C '02-08	<b>Top-End</b> 35.6011 '02-08						
	Please Note: Nikasil Piston Size -Molycoated Skirt	01.6019.A 01.6019.B 01.6019.C '09-23	39.46 39.47 39.48	02.6012 02.6012 02.6012 '09-23	<b>Bearing</b> 23.6203T9C3 '97-23 2x	<b>B/E Bearing</b> 22.162212F '01-23	<b>Crankpin</b> 06.1635.9 '01-23	<b>Top-End</b> 35.6011 '01-08 35.6012 '09-23								
<b>STREET</b> APRILIA CAGIVA HONDA KAWASAKI KTM SUZUKI YAMAHA	SX-E 3 Electronic	<b>Piston Kit</b> -	<b>Size</b> -	<b>Ring Set</b> -												
	SX-E 5 Electronic	<b>Piston Kit</b> -	<b>Size</b> -	<b>Ring Set</b> -												
<b>ATV-UTV</b> CAN-AM GAS GAS HONDA KAWASAKI KTM POLARIS SUZUKI YAMAHA	KTM 60 SX 2-Stroke Please Note: Nikasil Piston Size	<b>Piston Kit</b> -	<b>Size</b> 43.50	<b>Ring Set</b> -	<b>CrankBearing &amp; Seal Kit</b> 23.CBS61097 '97-99	<b>Con. Rod Kit</b> 03.6017 '97-99	<b>Complete</b> 34.6018 '97-99	<b>Clips</b> 05.1210C '97-99	<b>Top-End</b> 35.6018 '97-99							
				<b>Oilseal Set</b> 42.6017 '97-99	<b>Bearing</b> 23.6304C3 '97-99 2x	<b>S/E Bearing</b> 21.2001 '97-99	<b>Top-End</b> 35.6018 '97-99									
<b>PWC</b> KAWASAKI POLARIS SEA DOO YAMAHA					<b>B/E Bearing</b> 22.182415F '97-99	<b>Crankpin</b> 06.1856 '97-99										
<b>SNOW</b> ARCTIC CAT KAWASAKI LYNX MOTO-SKI POLARIS SKI DOO YAMAHA																
<b>MOPED &amp; SCOOTER</b>																
<b>MISC. TECH. SPECIAL</b>																

Footnotes: \* Bearings Only \*\* Rubbers included

<b>Throttle Cable</b> 53.110049 '02-07			<b>F/W Bearing</b> 23.S110009 '02-03 23.S111043 '04-08	<b>Front Pad Set</b> 37.106302 '02-08 37.106302BX '02-08 Box of 10			<b>Swingarm</b> 26.210169 '02-08	
<b>Water Pump Rebuild Kit</b> 57.6021 '02-08			<b>R/W Bearing</b> 23.S110009 '02-08					
<b>Air Filter</b> 52.60000 '00-08 52.60009 '09-23	<b>Cover Gasket</b> 19.G6012 '09-23 Outer		<b>F/W Bearing</b> 23.S110009 '97-01 23.S111043 '02-11 23.S111035 '12-23	<b>Frontbrake Disc</b> 37.BD16009 '02-23	<b>Front Sprocket</b> 07.FS60001-10 '01-08 07.FS60009-10 '09-23		<b>Swingarm</b> 26.210169 '97-03 26.210170 '04-08 26.210129 '09-23	<b>Seal &amp; Wiper</b> 40.S3547611P '12-16
<b>Throttle Cable</b> 53.110049 '06-11 53.112068 '12-20 53.112088 '21-23			<b>R/W Bearing</b> 23.S110009 '97-03 23.S111043 '04-14 23.S117011 '15-23	<b>Front Pad Set</b> 37.106302 '02-23 37.106302BX '02-23 Box of 10			<b>Upper</b> 26.450070 '10-23	<b>Dust Seal Set</b> 40.F3546.8DP '12-16
<b>Water Pump Rebuild Kit</b> 57.6021 '02-09 57.6022 '12-23			<b>Steering Bearing</b> 24.110047 '05-23	<b>Front Pad Set</b> 37.106302 '04-23 37.106302BX '04-23 Box of 10			<b>Lower</b> 26.450070 '10-23	
			<b>F/W Bearing</b> 23.S111035 '23	<b>Frontbrake Disc</b> 37.BD16009 '23			<b>Swingarm</b> 26.210129 '23	
			<b>Steering Bearing</b> 24.110047 '23	<b>Rearbrake Disc</b> 37.BD16009 '23				
			<b>F/W Bearing</b> 23.S111035 '20-23	<b>Frontbrake Disc</b> 37.BD16009 '20-23			<b>Swingarm</b> 26.210129 '20-23	
			<b>R/W Bearing</b> 23.S117011 '20-23	<b>Rearbrake Disc</b> 37.BD16009 '20-23			<b>Upper</b> 26.450070 '20-23	
			<b>Steering Bearing</b> 24.110047 '20-23	<b>Front Pad Set</b> 37.106302 '20-23 37.106302BX '20-23 Box of 10			<b>Lower</b> 26.450070 '20-23	
				<b>Rear Pad Set</b> 37.106302 '20-23 37.106302BX '20-23 Box of 10				
<b>Air Filter</b> 52.61097 '97-99		<b>Complete Plate Set</b> 16.CPS60098 '97-99	<b>F/W Bearing</b> 23.S111035 '97-99	<b>Front Pad Set</b> 37.102102 '97-99 37.102102BX '97-99 Box of 10	<b>Front Sprocket</b> 07.FS60004-12 07.FS60004-13 07.FS60004-14 07.FS60004-15 '97-99	<b>Chain</b> 07.RC420130C '97-99 MX	<b>Swingarm</b> 26.210129 '97-99	
<b>Throttle Cable</b> 53.112017 '98-00		<b>Friction Set</b> 16.S50012 '97-99	<b>R/W Bearing</b> 23.S113048 '97-99			<b>Countershaft Seal Kit</b> 26.640007 '98-99		
		<b>Steel Set</b> 16.S50013 '97-99	<b>Steering Bearing</b> 24.110047 '97-99		<b>7075-T6 Alloy Rear Sprocket</b> 07.RA60097-44 07.RA60097-45 07.RA60097-46 07.RA60097-47 07.RA60097-48 07.RA60097-49 07.RA60097-50 '97-99			
					<b>Sprocket Bolt Set</b> 07.SBSM825 '97-99			

<b>DIRT</b> APRILIA BETA BMW GAS GAS HONDA HUSABERG HUSQVARNA KAWASAKI	KTM MOTO TM RIEJU SHERCO SUZUKI YAMAHA
	KTM MOTO TM RIEJU SHERCO SUZUKI YAMAHA
	KTM SUZUKI YAMAHA
<b>STREET</b> APRILIA CAGIVA HONDA KAWASAKI KTM SUZUKI YAMAHA	KTM SUZUKI YAMAHA
	KTM SUZUKI YAMAHA
<b>ATV-UTV</b> CAN-AM GAS GAS HONDA KAWASAKI KTM POLARIS SUZUKI YAMAHA	KTM POLARIS SUZUKI YAMAHA
	KTM POLARIS SUZUKI YAMAHA
<b>PWC</b> KAWASAKI POLARIS SEA DOO YAMAHA	KAWASAKI POLARIS SEA DOO YAMAHA
	KAWASAKI POLARIS SEA DOO YAMAHA
<b>SNOW</b> ARCTIC CAT KAWASAKI LYNX MOTO-SKI POLARIS SKI DOO YAMAHA	ARCTIC CAT KAWASAKI LYNX MOTO-SKI POLARIS SKI DOO YAMAHA
	ARCTIC CAT KAWASAKI LYNX MOTO-SKI POLARIS SKI DOO YAMAHA
<b>MOPED &amp; SCOOTER</b>	
<b>MISC. TECH. SPECIAL</b>	



**KTM**

**DIRT**

- APRILIA
- BETA
- BMW
- GAS GAS
- HONDA
- HUSABERG
- HUSQVARNA
- KAWASAKI
- KTM
- MOTO TM
- RIEJU
- SHERCO
- SUZUKI
- YAMAHA

Model	Piston Kit	Size (mm)	Ring Set	Crankshaft	Con. Rod Kit	Complete			
KTM 65 SX 2-Stroke	01.6022.A	44.96	02.6022	10.6023	03.6017	34.6018			
	01.6022.B	44.97	02.6022	03-08	'00-02	'00-08			
Please Note: Nikasil Piston Size -Molycoated Skirt	01.6022.C	44.98	02.6022		03.6023	34.6019			
	'00-08		'00-08	<b>Crank Bearing &amp; Seal Kit</b>	03.6029	'09-22			
Please Note: Nikasil Piston Size -Molycoated Skirt	01.6029.A	44.96	02.6022	23.CBS61097	'09-23	<b>Top-End</b>			
	01.6029.B	44.97	02.6022	'00-08		35.6018			
Please Note: Nikasil Piston Size -Molycoated Skirt	01.6029.C	44.98	02.6022	23.CBS61009	<b>S/E Bearing</b>	'00-08			
	01.6029.D	44.99	02.6022	'09-23	21.2001	35.6019			
	'09-23		'09-23	<b>Bearing</b>	'00-23	'09-23			
			<b>Clips</b>	23.6304JR2	<b>B/E Bearing</b>	<b>Head &amp; Base</b>			
			05.1210C	'00-23 2x	22.182415F	36.6019			
			'00-23	<b>Oilseal Set</b>	'00-23	'09-23			
				42.6017	<b>Crankpin</b>				
				'00-08	06.1856				
				42.6029	'00-02				
				'09-23	06.1842				
					'03-08				
					06.1854.3				
					'09-23				

Footnotes: \* Bearings Only \*\* Rubbers included

**STREET**

- APRILIA
- CAGIVA
- HONDA
- KAWASAKI
- KTM
- SUZUKI
- YAMAHA

**ATV-UTV**

- CAN-AM
- GAS GAS
- HONDA
- KAWASAKI
- KTM
- POLARIS
- SUZUKI
- YAMAHA

**PWC**

- KAWASAKI
- POLARIS
- SEA DOO
- YAMAHA

**SNOW**

- ARCTIC CAT
- KAWASAKI
- LYNX
- MOTO-SKI
- POLARIS
- SKI DOO
- YAMAHA

**MOPED & SCOOTER**

**MISC. TECH. SPECIAL**

**DIRT**

- APRILIA
- BETA
- BMW
- GAS GAS
- HONDA
- HUSABERG
- HUSQVARNA
- KAWASAKI
- KTM
- MOTO TM
- RIEJU
- SHERCO
- SUZUKI
- YAMAHA

**STREET**

- APRILIA
- CAGIVA
- HONDA
- KAWASAKI
- KTM
- SUZUKI
- YAMAHA

**ATV-UTV**

- CAN-AM
- GAS GAS
- HONDA
- KAWASAKI
- KTM
- POLARIS
- SUZUKI
- YAMAHA

**PWC**

- KAWASAKI
- POLARIS
- SEA DOO
- YAMAHA

**SNOW**

- ARCTIC CAT
- KAWASAKI
- LYNX
- MOTO-SKI
- POLARIS
- SKI DOO
- YAMAHA

**MOPED & SCOOTER**

**MISC. TECH. SPECIAL**

Model	Air Filter	Basket	Complete Plate Set	F/W Bearing	Frontbrake Disc	Front Sprocket	Chain	Swingarm	Seal & Wiper
KTM 65 SX 2-Stroke	52.61097	17.6020F	16.CPS60098	23.S111035	37.BD16000	07.FS60004-12	07.RC420130C	26.210129	40.S354710P
	'00-23	'00-23	'00-08	'00-23	'00-23	07.FS60004-13	'00-23 MX	'00-23	'02-11
Please Note: Nikasil Piston Size -Molycoated Skirt	<b>Main Jet</b>	<b>Spring Kit</b>	<b>Friction Set</b>	<b>R/W Bearing</b>	<b>Rearbrake Disc</b>	07.FS60004-14	<b>Countershaft Seal Kit</b>	<b>Upper</b>	40.S3547611P
	47.090-580	17.CS60047	16.S50012	23.S113045	37.BD26000	07.FS60004-15	26.640007	26.450070	'12-16
Please Note: Nikasil Piston Size -Molycoated Skirt	'00-23 Mikuni	'00-08	'00-23	'00-23	'00-23	'00-23	'00-08	'02-08	'02-11
	<b>Pilot Jet</b>	<b>CLUTCH Master Cylinder Rebuild Kit</b>	<b>Steel Set</b>	<b>Steering Bearing</b>	<b>Front Pad Set</b>	<b>7075-T6 Alloy Rear Sprocket</b>	26.640006	'09-14	40.F354710P
48.015-080	16.940001	16.S50013	24.110047	37.102102	07.RA60097-44	07.RA60097-45	'09-23	40.F354611P	
'00-23 Mikuni	'02-04	'00-23	'00-23	'00-01	07.RA60097-46	07.RA60097-47		'12-16	
<b>Carburetor Rebuild Kit</b>	16.940004			37.102102BX	07.RA60097-48	07.RA60097-49			
55.10561	'05-13			'00-01 Box of 10	07.RA60097-48	07.RA60097-49			
'98-06	16.910055			37.109202	07.RA60097-49	07.RA60097-50			
55.10519	'14-22			37.109202BX	'00-23	'00-23			
'09-22	<b>Slave Cylinder Rebuild Kit</b>			'02-22 Box of 10	<b>Sprocket Bolt Set</b>				
<b>Throttle Cable</b>	16.950008			37.202302	07.SBSM825				
53.112017	'02-13			'23	'00-23				
'98-01	16.950013			37.202302BX					
53.110048	'14-22			'23 Box of 10					
'02-08									
53.110047									
'09-20									
53.112089									
'21-23									
<b>Water Pump Rebuild Kit</b>									
57.6018									
'98-08									
57.6029									
'09-23									



### KTM

**DIRT**  
APRILIA  
BETA  
BMW  
GAS GAS  
HONDA  
HUSABERG  
HUSQVARNA  
KAWASAKI  
KTM  
MOTO TM  
RIEJU  
SHERCO  
SUZUKI  
YAMAHA

KTM 85 SX 2-Stroke Please Note: Nikasil Piston Size -Molycoated Skirt	<b>Piston Kit</b> 01.6105.A 01.6105.B 01.6105.C 01.6105.D '03-23	<b>Size</b> 46.95 46.96 46.97 46.98	<b>Ring Set</b> 02.6105 02.6105 02.6105 02.6105 '03-23	<b>CrankBearing &amp; Seal Kit</b> 23.CBS61003 '03-23	<b>Con. Rod Kit</b> 03.6104 '03-12 03.6113 '13-23	<b>Complete</b> 34.6103 '03-12 34.6113 '13-17			
			<b>Clips</b> 05.1410C '03-23	<b>Bearing</b> 23.NJ205 '03-23 Left 23.6304/22 '03-23 Right	<b>S/E Bearing</b> 21.1111 '03-23	<b>Top-End</b> 35.6103 '03-12 35.6113 '13-17 35.6118 '18-23			
				<b>Oilseal Set</b> 42.6103 '03-23	<b>B/E Bearing</b> 22.222816F '03-12 22.202615F '13-23	<b>Head &amp; Base</b> 36.6113 '13-17 36.6118 '18-23			
					<b>Crankpin</b> 06.2245.9 '03-12 06.2045.9 '13-23	<b>Ignition Cover Gasket</b> 19.G96103 '03-13			

**STREET**  
APRILIA  
CAGIVA  
HONDA  
KAWASAKI  
KTM  
SUZUKI  
YAMAHA

**ATV-UTV**  
CAN-AM  
GAS GAS  
HONDA  
KAWASAKI  
KTM  
POLARIS  
SUZUKI  
YAMAHA

**PWC**  
KAWASAKI  
POLARIS  
SEA DOO  
YAMAHA

**SNOW**  
ARCTIC CAT  
KAWASAKI  
LYNX  
MOTO-SKI  
POLARIS  
SKI DOO  
YAMAHA

**MOPED & SCOOTER**

**MISC. TECH. SPECIAL**

Footnotes: \* Bearings Only \*\* Rubbers included

**DIRT**  
APRILIA  
BETA  
BMW  
GAS GAS  
HONDA  
HUSABERG  
HUSQVARNA  
KAWASAKI  
KTM  
MOTO TM  
RIEJU  
SHERCO  
SUZUKI  
YAMAHA

**STREET**  
APRILIA  
CAGIVA  
HONDA  
KAWASAKI  
KTM  
SUZUKI  
YAMAHA

**ATV-UTV**  
CAN-AM  
GAS GAS  
HONDA  
KAWASAKI  
KTM  
POLARIS  
SUZUKI  
YAMAHA

**PWC**  
KAWASAKI  
POLARIS  
SEA DOO  
YAMAHA

**SNOW**  
ARCTIC CAT  
KAWASAKI  
LYNX  
MOTO-SKI  
POLARIS  
SKI DOO  
YAMAHA

**MOPED & SCOOTER**

**MISC. TECH. SPECIAL**

<b>Air Filter</b> 52.62098 '03-04 52.62004 '05-12 52.62011 '13-17 52.61018 '18-23	<b>Basket</b> 17.6103F '03-17	<b>Complete Plate Set</b> 16.CPS61003 '03-17 16.CPS61018 '18-23	<b>F/W Bearing</b> 23.S110063 '03-11 23.S114006 '12-23	<b>Frontbrake Disc</b> 37.BD16103 '03-17 17/14 '03-11 19/16 37.BD16112 '12-23 19/16	<b>Front Sprocket</b> 07.FS61004-12 07.FS61004-13 07.FS61004-14 07.FS61004-15 '03-17	<b>Chain</b> 07.RC428130C '03-23 MX	<b>Swingarm</b> 26.210087 '03-23	<b>Seal &amp; Wiper</b> 40.S4352.99P '03-17
<b>Main Jet</b> 45.100-225 '03-23 Keihin	<b>Spring Kit</b> 17.CS61043 '03-17	<b>Friction Set</b> 16.S51011 '03-17	<b>R/W Bearing</b> 23.S112073 '03-23	<b>Rearbrake Disc</b> 37.BD26103 '03-10 17/14 '03-11 19/16 37.BD26111 '11-20 17/14 '12-20 19/16 37.BD26190 '21-23	<b>Countershaft Seal Kit</b> 26.640005 '03-23	<b>Upper</b> 26.350059 '03-23	<b>Oil Seal Set</b> 40.F4352.99P '03-17	
<b>Pilot Jet</b> 46.040-085 '03-23 Keihin	<b>Cover Gasket</b> 19.G6103 '03-17	<b>Steel Set</b> 16.S51012 '03-17 16.S51019 '18-23	<b>F/W Spacer Kit</b> 26.710083 '03-11 26.710105 '12-23	<b>7075-T6 Alloy Rear Sprocket</b> 07.RA61003-46 07.RA61003-47 07.RA61003-48 07.RA61003-49 07.RA61003-50 07.RA61003-51 '03-23	<b>Lower</b> 26.350059 '03-23	<b>Dust Seal Set</b> 40.F4353.4DP '03-17	<b>Bushing Set</b> 39.160052 '03-13 39.160121 '14-17	
<b>Carburetor Rebuild Kit</b> 55.10518 '03-22	<b>Master Cylinder Rebuild Kit</b> 16.940001 '03-04 16.940004 '05-12 16.910055 '14-23	<b>R/W Spacer Kit</b> 26.710084 '03-23	<b>Steering Bearing</b> 24.110047 '03-23	<b>Front Pad Set</b> 37.109202 '03-11 37.109202BX '03-11 Box of 10 37.160202 '12-20 37.160202BX '12-20 Box of 10 37.102202 '21-23 37.102202BX '21-23 Box of 10	<b>Rear Shock Seal Head Kit</b> 26.810120 '03-20			
<b>Throttle Cable</b> 53.110046 '03-17 53.112069 '18-20	<b>Slave Cylinder Rebuild Kit</b> 16.950008 '03-12 16.950013 '13-23			<b>Ultralight Steel Rear Sprocket</b> 07.RS61003R-46 07.RS61003R-47 07.RS61003R-48 07.RS61003R-49 07.RS61003R-50 07.RS61003R-51 '03-23	<b>Sprocket Bolt Set</b> 07.SBSM825 '03-23			
<b>Water Pump Rebuild Kit</b> 57.6123 '03-17				<b>Rear Pad Set</b> 37.109202 '03-10 37.109202BX '03-10 Box of 10 37.289102 '11-20 37.289102BX '11-20 Box of 10 37.202302 '21-23 37.202302BX '21-23 Box of 10	<b>Brake Pedal Rebuild Kit</b> 37.RBPK001 '03-17			
				<b>Front Master Cylinder Rebuild Kit</b> 37.910006 '05-13 16.910055 '14-22				

KTM 105 SX 2-Stroke	<b>Piston Kit</b> -	<b>Size</b> 52.00	<b>Ring Set</b> -	<b>CrankBearing &amp; Seal Kit</b> 23.CBS61003 '04-11	<b>Con. Rod Kit</b> 03.6104 '04-11	<b>Complete</b> 34.6012 '04-11			
				<b>Bearing</b> 23.NJ205 '04-11 Left 23.6304/22 '04-11 Right	<b>S/E Bearing</b> 21.1111 '04-11	<b>Ignition Cover Gasket</b> 19.G96103 '06-11			
				<b>Oilseal Set</b> 42.6103 '04-11	<b>B/E Bearing</b> 22.222816F '04-11				
					<b>Crankpin</b> 06.2245.9 '04-11				

**SNOW**  
ARCTIC CAT  
KAWASAKI  
LYNX  
MOTO-SKI  
POLARIS  
SKI DOO  
YAMAHA

**MOPED & SCOOTER**

**MISC. TECH. SPECIAL**



**PISTON KITS**

**SIZES**  
(mm)

**PISTON PARTS**

**CRANKSHAFT PARTS**

**CONNECTING ROD PARTS**

**GASKETS**

**VALVE TRAIN PARTS I**

**VALVE TRAIN PARTS II**

**AIR & FUEL PARTS**

**CLUTCH PARTS**

**CLUTCH PLATE SETS**

**WHEEL & STEERING PARTS**

**BRAKE PARTS**

**DRIVE CHAIN PARTS I**

**DRIVE CHAIN PARTS II**

**SUSPENSION BEARING KITS**

**SUSPENSION PARTS**

**KTM**
**DIRT**

KTM 125 EXC 2-Stroke	<b>Piston Kit</b> 01.6219.A 01.6219.B 01.6219.C 01.6219.D	<b>SIZE</b> (mm) 54.19 54.20 54.21 54.22	<b>Ring Set</b> 02.6219 02.6219 02.6219 02.6219	<b>CrankBearing &amp; Seal Kit</b> 23.CBS62001 '98-16	<b>Con. Rod Kit</b> 03.6220 '98-16	<b>Complete</b> 34.6201 '91-97 34.6218 '98-01 34.6222 '02-06 34.6227 '07-16			
Please Note: Nikasil Piston Size -Forged Piston				<b>Bearing</b> 23.NJ206 '98-16 Left 23.6305JR2 '98-16 Right	<b>S/E Bearing</b> 21.3206 '98-16				
Please Note: Nikasil Piston Size	01.6219.A 01.6219.B 01.6219.C 01.6219.D	54.19 54.20 54.21 54.22	02.6219 02.6219 02.6219 02.6219		<b>B/E Bearing</b> 22.222816F '98-16	<b>Top-End</b> 35.6211 '91-97 35.6220 '98-01 35.6222 '02-06 35.6227 '07-16			
Please Note: Nikasil Piston Size	01.6226.A 01.6226.B 01.6226.C 01.6226.D 01.6226.E	53.94 53.95 53.96 53.97 53.98	02.6225 02.6225 02.6225 02.6225 02.6225	<b>Oilseal Set</b> 42.6218 '98-16	<b>Crankpin</b> 06.2255 '98-16				
						<b>Ignition Cover Gasket</b> 19.G96213 '93-97 19.G96221 '98-08			
			<b>Pin</b> 04.1545 '94-16 <b>Clips</b> 05.1510 '94-16						

**STREET**

APRILIA BETA BMW GAS GAS HONDA HUSABERG HUSQVARNA KAWASAKI KTM MOTO TM RIEJU SHERCO SUZUKI YAMAHA									
--	--	--	--	--	--	--	--	--	--

**ATV-UTV**

CAN-AM GAS GAS HONDA KAWASAKI KTM POLARIS SUZUKI YAMAHA									
--	--	--	--	--	--	--	--	--	--

**PWC**

KAWASAKI POLARIS SEA DOO YAMAHA									
--	--	--	--	--	--	--	--	--	--

**SNOW**

ARCTIC CAT KAWASAKI LYNX MOTO-SKI POLARIS SKI DOO YAMAHA									
--	--	--	--	--	--	--	--	--	--

**MOPED & SCOOTER**
**MISC. TECH. SPECIAL**

Footnotes: \* Bearings Only \*\* Rubbers included

<b>Air Filter</b> 52.62086 '86-97 52.62098 '98-03 52.62004 '04-07 52.62007 '08-09 52.62010 '10-11 52.62011 '12-16	<b>Basket</b> 17.6218F * '98-05 17.6226F * '06-08 17.6218F * '09-16	<b>Complete Plate Set</b> 16.CPS62098 '98-05 16.CPS62006 '06-08 16.CPS62098 '09-10 16.CPS62008 '11-12 16.CPS62098 '13-16	<b>F/W Bearing</b> 23.S110063 '93-99 23.S110080 '00-02 23.S114002 '03-16	<b>Frontbrake Disc</b> 37.BD16290 '91-16	<b>Front Sprocket</b> 07.FS62093-12 07.FS62093-13 07.FS62093-14 07.FS62093-15 '91-16	<b>Chain</b> 07.RC520120C '90-16 MX 07.RC520120CG '90-16 MX Gold 07.RC520120XC '90-16 X-Ring 07.RC520120XCG '90-16 X-Ring Gold	<b>Swingarm</b> 26.210087 '93-97 26.210088 '98-03 26.210168 '04-16	<b>Seal &amp; Wiper</b> 40.S4352.99P '00-02 40.S4857.89 '03-15	<b>Oil Seal Set</b> 40.F4352.99P '00-02 40.F4857.89 '03-15	<b>Linkage</b> 26.110130 '93-97	<b>Upper</b> 26.350059 '02-16	<b>Dust Seal Set</b> 40.F4353.4DP '00-02 40.F4857.8D '03-15	<b>Lower</b> 26.410024 '93-97 26.410089 '98-16	<b>Bushing Set</b> 39.160053 '00-01 39.160077 '03-04 39.160054 '05-11 39.160074 '12-15	<b>Rear Shock Seal Head Kit</b> 26.810119 '99-16
<b>Main Jet</b> 45.100-225 '98-16 Keihin	<b>Inner Hub</b> 18.1290 '98-05+10-16	<b>Friction Set</b> 16.S52001 '98-16	<b>F/W Spacer Kit</b> 26.710085 '93-99 26.710088 '00-02 26.710087 '03-15 26.710103 '16	<b>Front Pad Set</b> 37.102202 '94-16 37.102202BX '94-16 Box of 10	<b>7075-T6 Alloy Rear Sprocket</b> 07.RA62090-48 07.RA62090-50 07.RA62090-51 07.RA62090-52 '90-16	<b>Countershaft Seal Kit</b> 26.640001 '98-16	<b>Lower Chain Roller</b> 33.0003 '93-05	<b>Upper Chain Roller</b> 33.0003 '93-08	<b>Ultralight Steel Rear Sprocket</b> 07.RS62090R-48 07.RS62090R-49 07.RS62090R-50 07.RS62090R-51 07.RS62090R-52 '90-16	<b>Sprocket Bolt Set</b> 07.SBSM825 '90-16					
<b>Pilot Jet</b> 46.040-085 '98-16 Keihin	<b>Pressure Plate</b> 18.P1286 '06-12	<b>Steel/Alloy</b> 16.S52002 '98-16	<b>R/W Spacer Kit</b> 26.710084 '93-16	<b>Rear Pad Set</b> 37.204202 '94-03 37.204202BX '94-03 Box of 10 37.202302 '04-16 Box of 10					<b>Front Caliper Rebuild Kit</b> 37.63047 '96-05						
<b>Carburetor Rebuild Kit</b> 55.10517 '98-05	<b>Spring Kit</b> 17.CS12003 '98-05 17.CS12002 '06-08 17.CS12003 '09-10 17.CS62048 '11-12 17.CS12003 '13-16		<b>Steering Bearing</b> 24.110026 '93-16	<b>Rear Caliper Rebuild Kit</b> 37.63050 '01-05 37.63048 '06	<b>Front Master Cylinder Rebuild Kit</b> 37.910025 '94-99 37.910023 '00-04 37.910022 '05 37.910024 '06-08 37.910026 '09-13 37.910035 '14-16				<b>Rear Master Cylinder Rebuild Kit</b> 37.910029 '94-99 37.910029 '01 37.910028 '02-12 37.910030 '13-16						
<b>Throttle Cable</b> 53.110046 '98-16	<b>Cover Gasket</b> 19.G6218 '98-16	<b>Master Cylinder Rebuild Kit</b> 16.940001 '02-08 16.940003 '09		<b>Slave Cylinder Rebuild Kit</b> 16.950006 '02-09	<b>Brake Pedal Rebuild Kit</b> 37.RBPK002 '98-03 37.RBPK001 '04-16										
<b>Water Pump Rebuild Kit</b> 57.6213 '93-97 57.6218 '98-16		<b>Slave Cylinder Rebuild Kit</b> 16.950006 '02-09													

**DIRT**

APRILIA  
BETA  
BMW  
GAS GAS  
HONDA  
HUSABERG  
HUSQVARNA  
KAWASAKI  
KTM  
MOTO TM  
RIEJU  
SHERCO  
SUZUKI  
YAMAHA

**STREET**

APRILIA  
CAGIVA  
HONDA  
KAWASAKI  
KTM  
SUZUKI  
YAMAHA

**ATV-UTV**

CAN-AM  
GAS GAS  
HONDA  
KAWASAKI  
KTM  
POLARIS  
SUZUKI  
YAMAHA

**PWC**

KAWASAKI  
POLARIS  
SEA DOO  
YAMAHA

**SNOW**

ARCTIC CAT  
KAWASAKI  
LYNX  
MOTO-SKI  
POLARIS  
SKI DOO  
YAMAHA

**MOPED & SCOOTER**
**MISC. TECH. SPECIAL**

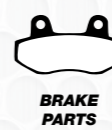

**KTM**
**DIRT**

 APRILIA  
 BETA  
 BMW  
 GAS GAS  
 HONDA  
 HUSABERG  
 HUSQVARNA  
 KAWASAKI  
 KTM  
 MOTO TM  
 RIEJU  
 SHERCO  
 SUZUKI  
 YAMAHA

KTM 125 XC-W 2-Stroke Please Note: Nikasil Piston Size	<b>Piston Kit</b> 01.6226.A 01.6226.B 01.6226.C 01.6226.D 01.6226.E '17-19	<b>Size (mm)</b> 53.94 53.95 53.96 53.97 53.98	<b>Ring Set</b> 02.6225 02.6225 02.6225 02.6225 02.6225 '17-19	<b>Crankbearing &amp; Seal Kit</b> 23.CBS62001 '17-19  <b>Bearing</b> 23.NJ206 '17-19 Left 23.6305JR2 '17-19 Right  <b>Oilseal Set</b> 42.6218 '17-19	<b>Con. Rod Kit</b> 03.6226 '17-19  <b>S/E Bearing</b> 21.3206 '17-19  <b>B/E Bearing</b> 22.222816F '17-19  <b>Crankpin</b> 06.2255.9 '17-19	<b>Top-End</b> 35.6216 '17-19  <b>Head &amp; Base</b> 36.6216 '17-19					
---	--	---	--	---	---	--	--	--	--	--	--

**STREET**

 APRILIA  
 CAGIVA  
 HONDA  
 KAWASAKI  
 KTM  
 SUZUKI  
 YAMAHA

**ATV-UTV**

 CAN-AM  
 GAS GAS  
 HONDA  
 KAWASAKI  
 KTM  
 POLARIS  
 SUZUKI  
 YAMAHA

KTM 144 SX 2-Stroke Please Note: Nikasil Piston Size -Molycoated Skirt	<b>Piston Kit</b> 01.6228.A 01.6228.B 01.6228.C 01.6228.D 01.6228.E '08	<b>Size</b> 55.94 55.95 55.96 55.97 55.98	<b>Ring Set</b> 02.6228 02.6228 02.6228 02.6228 02.6228 '08  <b>Clips</b> 05.1510 '08	<b>Crankshaft</b> 10.6228 '08  <b>Crankbearing &amp; Seal Kit</b> 23.CBS62001 '08  <b>Bearing</b> 23.NJ206 '08 Left 23.6305JR2 '08 Right  <b>Oilseal Set</b> 42.6218 '08	<b>Con. Rod Kit</b> 03.6220 '08  <b>S/E Bearing</b> 21.3206 '08  <b>B/E Bearing</b> 22.222816F '08  <b>Crankpin</b> 06.2255 '08	<b>Complete</b> 34.6227 '08  <b>Top-End</b> 35.6227 '08  <b>Ignition Cover Gasket</b> 19.G96221 '08					
--	---	--	---	--	---	---	--	--	--	--	--

**PWC**

 KAWASAKI  
 POLARIS  
 SEA DOO  
 YAMAHA

**SNOW**

 ARCTIC CAT  
 KAWASAKI  
 LYNX  
 MOTO-SKI  
 POLARIS  
 SKI DOO  
 YAMAHA

**MOPED & SCOOTER**
**MISC. TECH. SPECIAL**

Footnotes: \* Bearings Only \*\* Rubbers included

**DIRT**

 APRILIA  
 BETA  
 BMW  
 GAS GAS  
 HONDA  
 HUSABERG  
 HUSQVARNA  
 KAWASAKI  
 KTM  
 MOTO TM  
 RIEJU  
 SHERCO  
 SUZUKI  
 YAMAHA

**STREET**

 APRILIA  
 CAGIVA  
 HONDA  
 KAWASAKI  
 KTM  
 SUZUKI  
 YAMAHA

**ATV-UTV**

 CAN-AM  
 GAS GAS  
 HONDA  
 KAWASAKI  
 KTM  
 POLARIS  
 SUZUKI  
 YAMAHA

**PWC**

 KAWASAKI  
 POLARIS  
 SEA DOO  
 YAMAHA

**SNOW**

 ARCTIC CAT  
 KAWASAKI  
 LYNX  
 MOTO-SKI  
 POLARIS  
 SKI DOO  
 YAMAHA

**MOPED & SCOOTER**
**MISC. TECH. SPECIAL**

<b>Air Filter</b> 52.62016 '17-19  <b>Main Jet</b> 47.090-580 '17-19 Mikuni  <b>Pilot Jet</b> 49.010-045 '17-19 Mikuni	<b>Basket</b> 17.6218F * '17-18  <b>Clutch Rubber Set</b> 17.CRS1287-8 '17-18  <b>Inner Hub</b> 18.1290 '17-18  <b>Cover Gasket</b> 19.G6216 '17-18	<b>Complete Plate Set</b> 16.CPS63029 '19  <b>Friction Set</b> 16.S52001 '17-18  16.S53009 '19  <b>Steel/Alloy</b> 16.S52002 '17-18 16.S53010 '19	<b>F/W Bearing</b> 23.S114002 '17-19  <b>R/W Bearing</b> 23.S112073 '17-19  <b>F/W Spacer Kit</b> 26.710087 '17-19  <b>R/W Spacer Kit</b> 26.710084 '17-19  <b>Steering Bearing</b> 24.110026 '17-19	<b>Frontbrake Disc</b> 37.BD16290 '17-19  <b>Rearbrake Disc</b> 37.BD26190 '17-19  <b>Front Pad Set</b> 37.102202 '17-19 37.102202BX '17-19 Box of 10  <b>Rear Pad Set</b> 37.202302 '17-19 37.202302BX '17-19 Box of 10  <b>Front Caliper Rebuild Kit</b> 37.63046 '17-19  <b>Front Master Cylinder Rebuild Kit</b> 37.910035 '17-19  <b>Rear Master Cylinder Rebuild Kit</b> 37.910030 '17-19	<b>Front Sprocket</b> 07.FS62093-12 07.FS62093-13 07.FS62093-14 07.FS62093-15 '17-19  <b>7075-T6 Alloy Rear Sprocket</b> 07.RA62090-48 07.RA62090-49 07.RA62090-50 07.RA62090-51 07.RA62090-52 '17-19  <b>Ultralight Steel Rear Sprocket</b> 07.RS62090R-48 07.RS62090R-49 07.RS62090R-50 07.RS62090R-51 07.RS62090R-52 '17-19  <b>Sprocket Bolt Set</b> 07.SBSM825 '17-19	<b>Chain</b> 07.RC520120C '17-19 MX 07.RC520120CG '17-19 MX Gold 07.RC520120XC '17-19 X-Ring 07.RC520120XCG '17-19 X-Ring Gold  <b>Countershaft Seal Kit</b> 26.640045 '17-21	<b>Swingarm</b> 26.210125 '17-19  <b>Upper</b> 26.350059 '17-19  <b>Lower</b> 26.450077 '17-19	<b>Rear Shock Seal Head Kit</b> 26.810120 '17-19	<b>Air Filter</b> 52.62007 '08  <b>Main Jet</b> 45.100-225 '08 Keihin  <b>Pilot Jet</b> 46.040-085 '08 Keihin  <b>Carburetor Rebuild Kit</b> 55.10517 '08  <b>Throttle Cable</b> 53.110046 '08  <b>Water Pump Rebuild Kit</b> 57.6218 '08	<b>Basket</b> 17.6226F * '08  <b>Clutch Rubber Set</b> 17.CRS1287-8 '08  <b>Pressure Plate</b> 18.P1286 '08  <b>Spring Kit</b> 17.CS62048 '08  <b>Cover Gasket</b> 19.G6218 '08  <b>Master Cylinder Rebuild Kit</b> 16.940001 '08  <b>Slave Cylinder Rebuild Kit</b> 16.950006 '08	<b>Complete Plate Set</b> 16.CPS62008 '08  <b>Friction Set</b> 16.S52001 '08  <b>Steel/Alloy</b> 16.S52002 '08	<b>F/W Bearing</b> 23.S114002 '08  <b>R/W Bearing</b> 23.S112073 '08  <b>F/W Spacer Kit</b> 26.710087 '08  <b>R/W Spacer Kit</b> 26.710084 '08  <b>Steering Bearing</b> 24.110026 '08	<b>Frontbrake Disc</b> 37.BD16290 '08  <b>Rearbrake Disc</b> 37.BD26190 '08  <b>Front Pad Set</b> 37.102202 '08 37.102202BX '08 Box of 10  <b>Rear Pad Set</b> 37.202302 '08 37.202302BX '08 Box of 10  <b>Rear Caliper Rebuild Kit</b> 37.63048 '08  <b>Front Master Cylinder Rebuild Kit</b> 37.910024 '08  <b>Rear Master Cylinder Rebuild Kit</b> 37.910028 '08  <b>Brake Pedal Rebuild Kit</b> 37.RBPK001 '08	<b>Front Sprocket</b> 07.FS62093-12 07.FS62093-13 07.FS62093-14 07.FS62093-15 '08  <b>7075-T6 Alloy Rear Sprocket</b> 07.RA62090-48 07.RA62090-49 07.RA62090-50 07.RA62090-51 07.RA62090-52 '08  <b>Ultralight Steel Rear Sprocket</b> 07.RS62090R-48 07.RS62090R-49 07.RS62090R-50 07.RS62090R-51 07.RS62090R-52 '08  <b>Sprocket Bolt Set</b> 07.SBSM825 '08	<b>Chain</b> 07.RC520120C '08 MX 07.RC520120CG '08 MX Gold 07.RC520120XC '08 X-Ring 07.RC520120XCG '08 X-Ring Gold  <b>Countershaft Seal Kit</b> 26.640001 '08	<b>Swingarm</b> 26.210168 '08  <b>Upper</b> 26.350059 '08  <b>Lower</b> 26.410089 '08	<b>Seal &amp; Wiper</b> 40.S4857.89 '08  <b>Oil Seal Set</b> 40.F4857.89 '08  <b>Dust Seal Set</b> 40.F4857.8D '08  <b>Bushing Set</b> 39.160073 '08  <b>Rear Shock Seal Head Kit</b> 26.810119 '08
--	---	--	--	---	---	---	--	--	---	--	--	---	--	---	--	---	---



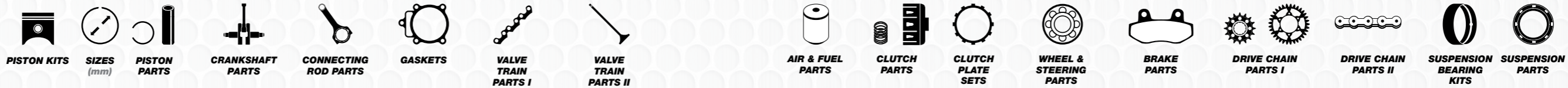

**KTM**

	<b>KTM 150 SX</b> 2-Stroke Please Note: Nikasil Piston Size -Molycoated Skirt	<b>Piston Kit</b> 01.6228.A 01.6228.B 01.6228.C 01.6228.D 01.6228.E '09-15	<b>Size (mm)</b> 55.94 55.95 55.96 55.97 55.98	<b>Ring Set</b> 02.6228 02.6228 02.6228 02.6228 02.6228 '09-15	<b>Crankshaft</b> 10.6228 '09-15	<b>Con. Rod Kit</b> 03.6220 '09-15 03.6226 '16-22	<b>Complete</b> 34.6227 '09-15 34.6216 '16-17							
	Please Note: Nikasil Piston Size -KTM Engine -Forged Piston	01.6237.A 01.6237.B 01.6237.C '16-22	57.94 57.95 57.96	02.6237 02.6237 02.6237 '16-22	<b>Crankbearing &amp; Seal Kit</b> 23.CBS62001 '09-22	<b>S/E Bearing</b> 21.3206 '09-22	<b>Top-End</b> 35.6227 '09-15 35.6216 '16-22							
				<b>Bearing</b> 23.NJ206 '09-22 Left 23.6305JR2 '09-22 Right		<b>B/E Bearing</b> 22.222816F '09-22	<b>Head &amp; Base</b> 36.6236 '16-22							
				<b>Clips</b> 05.1510 '09-22	<b>Oilseal Set</b> 42.6218 '09-22	<b>Crankpin</b> 06.2255 '09-15 06.2255.9 '16-22	<b>Ignition Cover Gasket</b> 19.G96221 '09-15							

Footnotes: \* Bearings Only \*\* Rubbers included

<b>Air Filter</b> 52.62007 '09 52.62010 '10 52.62011 '11-15 52.62016 '16-22	<b>Basket</b> 17.6218F * '09-18 <b>Clutch Rubber Set</b> 17.CRS1287-8 '09-18 <b>Inner Hub</b> 18.1290 '10-18 <b>Pressure Plate</b> 18.P1286 '09-12 <b>Spring Kit</b> 17.CS62048 '09-18 <b>Cover Gasket</b> 19.G6216 '16-22 <b>Master Cylinder Rebuild Kit</b> 16.940003 '09-15 16.940010 '16-22 <b>Slave Cylinder Rebuild Kit</b> 16.950006 '09-15 16.950014 '16-22	<b>Complete Plate Set</b> 16.CPS62008 '09-18 16.CPS63029 '19-22 <b>Friction Set</b> 16.S52001 '09-18 16.S53009 '19-22 <b>Steel/Alloy</b> 16.S52002 '09-18 16.S53010 '19-22	<b>F/W Bearing</b> 23.S114002 '09-22 <b>R/W Bearing</b> 23.S112073 '09-22 <b>F/W Spacer Kit</b> 26.710087 '09-14 26.710103 '15-22 <b>R/W Spacer Kit</b> 26.710084 '09-12 26.710102 '13-22 <b>Steering Bearing</b> 24.110026 '09-22	<b>Frontbrake Disc</b> 37.BD16290 '09-22 <b>Rearbrake Disc</b> 37.BD26190 '09-22 <b>Front Pad Set</b> 37.102202 '09-22 37.102202BX '09-22 Box of 10 <b>Rear Pad Set</b> 37.202302 '09-22 37.202302BX '09-22 Box of 10 <b>Front Caliper Rebuild Kit</b> 37.63046 '09-22 <b>Rear Caliper Rebuild Kit</b> 37.63048 '09-22 <b>Front Master Cylinder Rebuild Kit</b> 37.910026 '09-13 37.910035 '14-22 <b>Rear Master Cylinder Rebuild Kit</b> 37.910028 '09-11 37.910030 '12-22 <b>Brake Pedal Rebuild Kit</b> 37.RBPK001 '09-15 37.RBPK003 '16-17	<b>Front Sprocket</b> 07.FS62093-12 07.FS62093-13 07.FS62093-14 07.FS62093-15 '09-22 <b>7075-T6 Alloy Rear Sprocket</b> 07.RA62090-48 07.RA62090-50 07.RA62090-51 07.RA62090-52 '09-22 <b>Ultralight Steel Rear Sprocket</b> 07.RS62090R-48 07.RS62090R-49 07.RS62090R-50 07.RS62090R-51 07.RS62090R-52 '09-22 <b>Sprocket Bolt Set</b> 07.SBSM825 '09-22	<b>Chain</b> 07.RC520120C '09-22 MX 07.RC520120CG '09-22 MX Gold 07.RC520120XC '09-22 X-Ring 07.RC520120XCG '09-22 X-Ring Gold <b>Countershaft Seal Kit</b> 26.640001 '09-15 26.640045 '16-22	<b>Swingarm</b> 26.210168 '09-15 26.210125 '16-22 <b>Linkage</b> 26.110180 '12-20 <b>Upper</b> 26.350059 '09-11 26.450068 '12-22 <b>Lower</b> 26.410089 '09-11 26.450066 '12-20	<b>Seal &amp; Wiper</b> 40.S4857.89 '09-14 <b>Oil Seal Set</b> 40.F4857.89 '09-14 <b>Dust Seal Set</b> 40.F4857.8D '09-14 <b>Bushing Set</b> 39.160073 '09-11 39.160082 '12-14 39.160122 '15-16 <b>Rear Shock Seal Head Kit</b> 26.810119 '09-11 26.810127 '12-20						

**DIRT**  
APRILIA  
BETA  
BMW  
GAS GAS  
HONDA  
HUSABERG  
HUSQVARNA  
KAWASAKI  
KTM  
MOTO TM  
RIEJU  
SHERCO  
SUZUKI  
YAMAHA

**STREET**  
APRILIA  
CAGIVA  
HONDA  
KAWASAKI  
KTM  
SUZUKI  
YAMAHA

**ATV-UTV**  
CAN-AM  
GAS GAS  
HONDA  
KAWASAKI  
KTM  
POLARIS  
SUZUKI  
YAMAHA

**PWC**  
KAWASAKI  
POLARIS  
SEA DOO  
YAMAHA

**SNOW**  
ARCTIC CAT  
KAWASAKI  
LYNX  
MOTO-SKI  
POLARIS  
SKI DOO  
YAMAHA

**MOPED & SCOOTER**

**MISC. TECH. SPECIAL**

**DIRT**  
APRILIA  
BETA  
BMW  
GAS GAS  
HONDA  
HUSABERG  
HUSQVARNA  
KAWASAKI  
KTM  
MOTO TM  
RIEJU  
SHERCO  
SUZUKI  
YAMAHA

**STREET**  
APRILIA  
CAGIVA  
HONDA  
KAWASAKI  
KTM  
SUZUKI  
YAMAHA

**ATV-UTV**  
CAN-AM  
GAS GAS  
HONDA  
KAWASAKI  
KTM  
POLARIS  
SUZUKI  
YAMAHA

**PWC**  
KAWASAKI  
POLARIS  
SEA DOO  
YAMAHA

**SNOW**  
ARCTIC CAT  
KAWASAKI  
LYNX  
MOTO-SKI  
POLARIS  
SKI DOO  
YAMAHA

**MOPED & SCOOTER**

**MISC. TECH. SPECIAL**



**KTM****DIRT**

- APRILIA
- BETA
- BMW
- GAS GAS
- HONDA
- HUSABERG
- HUSQVARNA
- KAWASAKI
- KTM**
- MOTO TM
- RIEJU
- SHERCO
- SUZUKI
- YAMAHA

KTM 150 XC-W 2-Stroke Please Note: Nikasil Piston Size -KTM Engine -Forged Piston	<b>Piston Kit</b> 01.6237.A 01.6237.B 01.6237.C '17-19	<b>Size</b> 57.94 57.95 57.96	<b>Ring Set</b> 02.6237 02.6237 02.6237 '17-19	<b>CrankBearing &amp; Seal Kit</b> 23.CBS62001 '17-19	<b>Con. Rod Kit</b> 03.6226 '17-19	<b>Complete</b> 34.6216 '17					
			<b>Clips</b> 05.1510 '17-19	<b>Bearing</b> 23.NJ206 '17-19 Left 23.6305JR2 '17-19 Right	<b>S/E Bearing</b> 21.3206 '17-19	<b>Top-End</b> 35.6216 '17-19					
				<b>Oilseal Set</b> 42.6218 '17-19	<b>B/E Bearing</b> 22.222816F '17-19	<b>Head &amp; Base</b> 36.6236 '17-19					
					<b>Crankpin</b> 06.2255.9 '17-19	<b>Ignition Cover Gasket</b> 19.G96217 '17					

**STREET**

- APRILIA
- CAGIVA
- HONDA
- KAWASAKI
- KTM
- SUZUKI
- YAMAHA

**ATV-UTV**

- CAN-AM
- GAS GAS
- HONDA
- KAWASAKI
- KTM
- POLARIS
- SUZUKI
- YAMAHA

**PWC**

- KAWASAKI
- POLARIS
- SEA DOO
- YAMAHA

**SNOW**

- ARCTIC CAT
- KAWASAKI
- LYNX
- MOTO-SKI
- POLARIS
- SKI DOO
- YAMAHA

**MOPED & SCOOTER****MISC. TECH. SPECIAL**

KTM 150 EXC TPI 2-Stroke Please Note: Nikasil Piston Size -KTM Engine -Forged Piston - Fuel Injection	<b>Piston Kit</b> 01.6237.A 01.6237.B 01.6237.C '20	<b>Size</b> 57.94 57.95 57.96	<b>Ring Set</b> 02.6237 02.6237 02.6237 '20	<b>CrankBearing &amp; Seal Kit</b> 23.CBS62001 '20-23	<b>Con. Rod Kit</b> 03.6226 '20-23	<b>Top-End</b> 35.6216 '22-23					
				<b>Bearing</b> 23.NJ206 '20-23 Left 23.6305JR2 '20-23 Right	<b>S/E Bearing</b> 21.3206 '20-23	<b>Head &amp; Base</b> 36.6236 '20-23					
				<b>Oilseal Set</b> 42.6218 '20-23	<b>B/E Bearing</b> 22.222816F '20-23						
					<b>Crankpin</b> 06.2255.9 '20-23						
			<b>Pin</b> 04.1546.9 '21-23								
			<b>Clips</b> 05.1510 '20-23								

Footnotes: \* Bearings Only \*\* Rubbers included

**DIRT**

- APRILIA
- BETA
- BMW
- GAS GAS
- HONDA
- HUSABERG
- HUSQVARNA
- KAWASAKI
- KTM**
- MOTO TM
- RIEJU
- SHERCO
- SUZUKI
- YAMAHA

**STREET**

- APRILIA
- CAGIVA
- HONDA
- KAWASAKI
- KTM
- SUZUKI
- YAMAHA

**ATV-UTV**

- CAN-AM
- GAS GAS
- HONDA
- KAWASAKI
- KTM
- POLARIS
- SUZUKI
- YAMAHA

**PWC**

- KAWASAKI
- POLARIS
- SEA DOO
- YAMAHA

**SNOW**

- ARCTIC CAT
- KAWASAKI
- LYNX
- MOTO-SKI
- POLARIS
- SKI DOO
- YAMAHA

**MOPED & SCOOTER****MISC. TECH. SPECIAL**

<b>Air Filter</b> 52.62016 '17-19	<b>Basket</b> 17.6218F * '17-18	<b>Complete Plate Set</b> 16.CPS63029 '19	<b>F/W Bearing</b> 23.S114002 '17-19	<b>Frontbrake Disc</b> 37.BD16290 '17-19	<b>Front Sprocket</b> 07.FS62093-12 07.FS62093-13 07.FS62093-14 07.FS62093-15 '17-19	<b>Chain</b> 07.RC520120C '17-19 MX 07.RC520120CG '17-19 MX Gold 07.RC520120XC '17-19 X-Ring 07.RC520120XCG '17-19 X-Ring Gold	<b>Swingarm</b> 26.210125 '17-19	<b>Rear Shock Seal Head Kit</b> 26.810120 '17-19
<b>Main Jet</b> 47.090-580 '17-19 Mikuni	<b>Clutch Rubber Set</b> 17.CRS1287-8 '17-18	<b>Friction Set</b> 16.S52001 '17-18	<b>R/W Bearing</b> 23.S112073 '17-19	<b>Rearbrake Disc</b> 37.BD26190 '17-19			<b>Upper</b> 26.350059 '17-19	
<b>Pilot Jet</b> 49.010-045 '17-19 Mikuni	<b>Inner Hub</b> 18.1290 '17-18	<b>Steel/Alloy</b> 16.S53009 '19	<b>F/W Spacer Kit</b> 26.710103 '17-19	<b>Front Pad Set</b> 37.102202 '17-19	<b>7075-T6 Alloy Rear Sprocket</b> 07.RA62090-48 07.RA62090-49 07.RA62090-50 07.RA62090-51 07.RA62090-52 '17-19	<b>Countershaft Seal Kit</b> 26.640045 '17-19	<b>Lower</b> 26.450077 '17-19	
<b>Throttle Cable</b> 53.112059 '17	<b>Cover Gasket</b> 19.G6216 '17-19	<b>Steel/Alloy</b> 16.S52002 '17-18 16.S53010 '19	<b>R/W Spacer Kit</b> 26.710084 '17-19	<b>Front Pad Set</b> 37.102202BX '17-19 Box of 10				
<b>Water Pump Rebuild Kit</b> 57.6216 '17			<b>Steering Bearing</b> 24.110026 '17-19	<b>Rear Pad Set</b> 37.202302 '17-19	<b>Ultralight Steel Rear Sprocket</b> 07.RS62090R-48 07.RS62090R-49 07.RS62090R-50 07.RS62090R-51 07.RS62090R-52 '17-19			
				<b>Front Caliper Rebuild Kit</b> 37.63046 '17-19	<b>Sprocket Bolt Set</b> 07.SBSM825 '17-19			
				<b>Front Master Cylinder Rebuild Kit</b> 37.910035 '17-19				
				<b>Rear Master Cylinder Rebuild Kit</b> 37.910030 '17-19				
				<b>Brake Pedal Rebuild Kit</b> 37.RBPK001 '17				
<b>Air Filter</b> 52.62016 '20-23	<b>Cover Gasket</b> 19.G6216 '20-23	<b>Complete Plate Set</b> 16.CPS63029 '20-23	<b>F/W Bearing</b> 23.S114002 '20-23	<b>Frontbrake Disc</b> 37.BD16290 '20-23	<b>Front Sprocket</b> 07.FS62093-12 07.FS62093-13 07.FS62093-14 07.FS62093-15 '20-23	<b>Chain</b> 07.RC520120C '20-23 MX 07.RC520120CG '20-23 MX Gold 07.RC520120XC '20-23 X-Ring 07.RC520120XCG '20-23 X-Ring Gold	<b>Swingarm</b> 26.210125 '20-23	<b>Rear Shock Seal Head Kit</b> 26.810120 '20
<b>Throttle Cable</b> 53.112072 '20-22 53.112091 '23		<b>Friction Set</b> 16.S53009 '20-23	<b>R/W Bearing</b> 23.S112073 '20-23	<b>Rearbrake Disc</b> 37.BD26190 '20-23			<b>Upper</b> 26.350059 '20-23	
		<b>Steel/Alloy</b> 16.S53010 '20-23	<b>F/W Spacer Kit</b> 26.710103 '20-23	<b>Front Pad Set</b> 37.102202 '20-23 37.102202BX '20-23 Box of 10	<b>7075-T6 Alloy Rear Sprocket</b> 07.RA62090-48 07.RA62090-49 07.RA62090-50 07.RA62090-51 07.RA62090-52 '20-23	<b>Countershaft Seal Kit</b> 26.640045 '20-23	<b>Lower</b> 26.450077 '20-23	
			<b>R/W Spacer Kit</b> 26.710084 '20-23	<b>Rear Pad Set</b> 37.202302 '20-23	<b>Ultralight Steel Rear Sprocket</b> 07.RS62090R-48 07.RS62090R-49 07.RS62090R-50 07.RS62090R-51 07.RS62090R-52 '20-23			
			<b>Steering Bearing</b> 24.110026 '20-23	<b>Front Caliper Rebuild Kit</b> 37.63046 '20-23	<b>Sprocket Bolt Set</b> 07.SBSM825 '20-23			
				<b>Front Master Cylinder Rebuild Kit</b> 37.910035 '20-23				
				<b>Rear Master Cylinder Rebuild Kit</b> 37.910030 '20-23				





**KTM**

**DIRT**  
APRILIA  
BETA  
BMW  
GAS GAS  
HONDA  
HUSABERG  
HUSQVARNA  
KAWASAKI  
KTM  
MOTO TM  
RIEJU  
SHERCO  
SUZUKI  
YAMAHA

KTM 200 SX  
2-Stroke  
Please Note:  
Nikasil Piston Size

Piston Kit	Size	Ring Set	CrankBearing & Seal Kit	Con. Rod Kit	Complete
-	64.00	-	23.CBS62001 '03-05	03.6248 '03-05	34.6253 '03-05
		<b>Clips</b> 05.1612C '03-05	<b>Bearing</b> 23.NJ206 '03-05 Left 23.6305JR2 '03-05 Right	<b>S/E Bearing</b> 21.2250 '03-05	<b>Top-End</b> 35.6253 '03-05
			<b>Oilseal Set</b> 42.6218 '03-05	<b>B/E Bearing</b> 22.222816F '03-05	<b>Ignition Cover Gasket</b> 19.G96221 '03-05
				<b>Crankpin</b> 06.2255 '03-05	

**STREET**  
APRILIA  
CAGIVA  
HONDA  
KAWASAKI  
KTM  
SUZUKI  
YAMAHA

**ATV-UTV**  
CAN-AM  
GAS GAS  
HONDA  
KAWASAKI  
KTM  
POLARIS  
SUZUKI  
YAMAHA

**PWC**  
KAWASAKI  
POLARIS  
SEA DOO  
YAMAHA

**SNOW**  
ARCTIC CAT  
KAWASAKI  
LYNX  
MOTO-SKI  
POLARIS  
SKI DOO  
YAMAHA

**MOPED & SCOOTER**

**MISC. TECH. SPECIAL**

Footnotes: \* Bearings Only \*\* Rubbers included

Air Filter	Basket	Complete Plate Set	F/W Bearing	Frontbrake Disc	Front Sprocket	Chain	Swingarm	Seal & Wiper
52.62098 '03 52.62004 '04-05	17.6218F * '03-05	16.CPS62008 '03-05	23.S114002 '03-05	37.BD16290 '03-05	07.FS62093-12 07.FS62093-13 07.FS62093-14 07.FS62093-15 '03-05	07.RC520120C '03-05 MX 07.RC520120CG '03-05 MX Gold 07.RC520120XC '03-05 X-Ring 07.RC520120XCG '03-05 X-Ring Gold	26.210088 '03 26.210168 '04-05	40.S4858.89 '03-05
<b>Main Jet</b> 45.100-225 '03-05 Keihin	<b>Clutch Rubber Set</b> 17.CRS1287-8 '03-05	<b>Friction Set</b> 16.S52001 '03-05	<b>R/W Bearing</b> 23.S112073 '03-05	<b>Rearbrake Disc</b> 37.BD26190 '03-05	<b>7075-T6 Alloy Rear Sprocket</b> 07.RA62090-48 07.RA62090-49 07.RA62090-50 07.RA62090-51 07.RA62090-52 '03-05	<b>Countershaft Seal Kit</b> 26.640001 '03-05	<b>Upper</b> 26.350059 '03-05	<b>Oil Seal Set</b> 40.F4857.89 '03-05
<b>Pilot Jet</b> 46.040-085 '03-05 Keihin	<b>Inner Hub</b> 18.1290 '03-05	<b>Steel/Alloy</b> 16.S52002 '03-05	<b>F/W Spacer Kit</b> 26.710087 '03-05	<b>Front Pad Set</b> 37.102202 '03-05 37.102202BX '03-05 Box of 10	<b>UltraLight Steel Rear Sprocket</b> 07.RS62090R-48 07.RS62090R-49 07.RS62090R-50 07.RS62090R-51 07.RS62090R-52 '03-05	<b>Lower Chain Roller</b> 33.0003 '03-05	<b>Lower</b> 26.410089 '03-05	<b>Dust Seal Set</b> 40.F4857.8D '03-05
<b>Carburetor Rebuild Kit</b> 55.10517 '03-04	<b>Spring Kit</b> 17.CS62048 '03-05		<b>R/W Spacer Kit</b> 26.710084 '03-05	<b>Rear Pad Set</b> 37.204202 '03 37.204202BX '03 Box of 10 37.202302 '04-05 37.202302BX '04-05 Box of 10	<b>Steering Bearing</b> 24.110026 '03-05	<b>Upper Chain Roller</b> 33.0003 '03-05	<b>Bushing Set</b> 39.160077 '03-05	<b>Rear Shock Seal Head Kit</b> 26.810119 '03-05
<b>Throttle Cable</b> 53.110046 '03-05	<b>Cover Gasket</b> 19.G6218 '03-05	<b>Master Cylinder Rebuild Kit</b> 16.940001 '03-04		<b>Front Caliper Rebuild Kit</b> 37.63047 '00-05	<b>Sprocket Bolt Set</b> 07.SBSM825 '03-05			
<b>Water Pump Rebuild Kit</b> 57.6218 '00-05	<b>Slave Cylinder Rebuild Kit</b> 16.950006 '03-04			<b>Rear Caliper Rebuild Kit</b> 37.63050 '01-02 37.63048 '03-05				
				<b>Front Master Cylinder Rebuild Kit</b> 37.910023 '03-05				
				<b>Rear Master Cylinder Rebuild Kit</b> 37.910029 '03 37.910028 '04-05				
				<b>Brake Pedal Rebuild Kit</b> 37.RBPK002 '03 37.RBPK001 '04-05				

**DIRT**  
APRILIA  
BETA  
BMW  
GAS GAS  
HONDA  
HUSABERG  
HUSQVARNA  
KAWASAKI  
KTM  
MOTO TM  
RIEJU  
SHERCO  
SUZUKI  
YAMAHA

**STREET**  
APRILIA  
CAGIVA  
HONDA  
KAWASAKI  
KTM  
SUZUKI  
YAMAHA

**ATV-UTV**  
CAN-AM  
GAS GAS  
HONDA  
KAWASAKI  
KTM  
POLARIS  
SUZUKI  
YAMAHA

**PWC**  
KAWASAKI  
POLARIS  
SEA DOO  
YAMAHA

**SNOW**  
ARCTIC CAT  
KAWASAKI  
LYNX  
MOTO-SKI  
POLARIS  
SKI DOO  
YAMAHA

**MOPED & SCOOTER**

**MISC. TECH. SPECIAL**



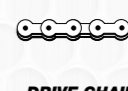

**KTM**

**DIRT**

- APRILIA
- BETA
- BMW
- GAS GAS
- HONDA
- HUSABERG
- HUSQVARNA
- KAWASAKI
- KTM**
- MOTO TM
- RIEJU
- SHERCO
- SUZUKI
- YAMAHA

KTM 200 EXC 2-Stroke Please Note: Nikasil Piston Size	Piston Kit 01.6249.A 01.6249.B 01.6249.C 01.6249.D '98-16	Size 63.94 63.95 63.96 63.97	Ring Set 02.6249 02.6249 02.6249 02.6249 '98-16	CrankBearing & Seal Kit 23.CBS62001 '98-16	Con. Rod Kit 03.6248 '98-16	Complete 34.6248 '98-02 34.6253 '03-12 34.6313 '13-16			
			<b>Clips</b> 05.1612C '98-16	<b>Bearing</b> 23.NJ206 '98-16 Left 23.6305JR2 '98-16 Right	<b>S/E Bearing</b> 21.2250 '98-16	<b>Top-End</b> 35.6248 '98-02 35.6253 '03-16			
				<b>Oilseal Set</b> 42.6218 '98-16	<b>B/E Bearing</b> 22.222816F '98-16	<b>Ignition Cover Gasket</b> 19.G96221 '98-12 19.G96313 '13-16			
					<b>Crankpin</b> 06.2255 '98-16				

Footnotes: \* Bearings Only \*\* Rubbers included

**STREET**

- APRILIA
- CAGIVA
- HONDA
- KAWASAKI
- KTM
- SUZUKI
- YAMAHA

**ATV-UTV**

- CAN-AM
- GAS GAS
- HONDA
- KAWASAKI
- KTM
- POLARIS
- SUZUKI
- YAMAHA

**PWC**

- KAWASAKI
- POLARIS
- SEA DOO
- YAMAHA

**SNOW**

- ARCTIC CAT
- KAWASAKI
- LYNX
- MOTO-SKI
- POLARIS
- SKI DOO
- YAMAHA

**MOPED & SCOOTER**

**MISC. TECH. SPECIAL**

**DIRT**

- APRILIA
- BETA
- BMW
- GAS GAS
- HONDA
- HUSABERG
- HUSQVARNA
- KAWASAKI
- KTM**
- MOTO TM
- RIEJU
- SHERCO
- SUZUKI
- YAMAHA

**STREET**

- APRILIA
- CAGIVA
- HONDA
- KAWASAKI
- KTM
- SUZUKI
- YAMAHA

**ATV-UTV**

- CAN-AM
- GAS GAS
- HONDA
- KAWASAKI
- KTM
- POLARIS
- SUZUKI
- YAMAHA

**PWC**

- KAWASAKI
- POLARIS
- SEA DOO
- YAMAHA

**SNOW**

- ARCTIC CAT
- KAWASAKI
- LYNX
- MOTO-SKI
- POLARIS
- SKI DOO
- YAMAHA

**MOPED & SCOOTER**

**MISC. TECH. SPECIAL**

<b>Air Filter</b> 52.62098 '98-03 52.62004 '04-07 52.62007 '08-09 52.62010 '10-11 52.62011 '12-16	<b>Basket</b> 17.6218F * '98-06 17.6226F * '07-08 17.6218F * '09-16	<b>Complete Plate Set</b> 16.CPS62008 '98-16	<b>F/W Bearing</b> 23.S110061 '98-99 23.S110080 '00-02 23.S114002 '03-16	<b>Frontbrake Disc</b> 37.BD16290 '98-16	<b>Front Sprocket</b> 07.FS62093-12 07.FS62093-13 07.FS62093-14 07.FS62093-15 '98-16	<b>Chain</b> 07.RC520120C '98-16 MX 07.RC520120CG '98-16 MX Gold 07.RC520120XC '98-16 X-Ring 07.RC520120XCG '98-16 X-Ring Gold	<b>Swingarm</b> 26.210088 '98-03 26.210168 '04-16	<b>Seal &amp; Wiper</b> 40.S4857.89 '04-15
<b>Main Jet</b> 45.100-225 '98-16 Keihin	<b>Clutch Rubber Set</b> 17.CRS1287-8 '98-16	<b>Friction Set</b> 16.S52001 '98-16	<b>R/W Bearing</b> 23.S112073 '98-16	<b>Rearbrake Disc</b> 37.BD26190 '98-16	<b>7075-T6 Alloy Rear Sprocket</b> 07.RA62090-48 07.RA62090-49 07.RA62090-50 07.RA62090-51 07.RA62090-52 '98-16	<b>Upper</b> 26.350059 '02-16	<b>Oil Seal Set</b> 40.F4857.89 '04-15	
<b>Pilot Jet</b> 46.040-085 '98-16 Keihin	<b>Inner Hub</b> 18.1290 '98-06+'10-16	<b>Steel/Alloy</b> 16.S52002 '98-16	<b>F/W Spacer Kit</b> 26.710085 '98-99 26.710088 '00-02 26.710087 '03-15 26.710103 '16	<b>Front Pad Set</b> 37.102202 '98-16 37.102202BX '98-16 Box of 10	<b>Countershaft Seal Kit</b> 26.640001 '98-16	<b>Dust Seal Set</b> 40.F4857.8D '04-15	<b>Lower Chain Roller</b> 33.0003 '98-05	
<b>Carburetor Rebuild Kit</b> 55.10517 '98-06 55.10514 '07-16	<b>Pressure Plate</b> 18.P1286 '07-12		<b>R/W Spacer Kit</b> 26.710084 '98-16	<b>Rear Pad Set</b> 37.204202 '98-03 37.204202BX '98-03 Box of 10 37.202302 '04-16 37.202302BX '04-16 Box of 10	<b>Lower Chain Roller</b> 33.0003 '98-05	<b>Bushing Set</b> 39.160053 '00-01 39.160077 '03-04 39.160054 '05-07 39.160073 '08-11 39.160074 '12-15	<b>Upper Chain Roller</b> 33.0003 '98-07	
<b>Throttle Cable</b> 53.110046 '98-16	<b>Cover Gasket</b> 19.G6218 '98-16		<b>Steering Bearing</b> 24.110026 '98-16	<b>Front Caliper Rebuild Kit</b> 37.63047 '98-05	<b>Sprocket Bolt Set</b> 07.SBSM825 '98-16	<b>Rear Shock Seal Head Kit</b> 26.810119 '99-16		
<b>Water Pump Rebuild Kit</b> 57.6218 '98-16	<b>Master Cylinder Rebuild Kit</b> 16.940002 '98-03 16.940001 '04-08 16.940003 '09-16			<b>Rear Caliper Rebuild Kit</b> 37.63050 '01-03 37.63048 '04-05				
	<b>Slave Cylinder Rebuild Kit</b> 16.950007 '98-99 16.950006 '00-16			<b>Front Master Cylinder Rebuild Kit</b> 37.910025 '98-99 37.910023 '00-04 37.910022 '05 37.910024 '06-08 37.910026 '09-13 37.910035 '14-16				
				<b>Rear Master Cylinder Rebuild Kit</b> 37.910029 '98-99 + '01-03 37.910028 '04-12 37.910030 '13-16				
				<b>Brake Pedal Rebuild Kit</b> 37.RBPK002 '98-03 37.RBPK001 '04-16				





**DIRT**  
APRILIA  
BETA  
BMW  
GAS GAS  
HONDA  
HUSABERG  
HUSQVARNA  
KAWASAKI  
KTM  
MOTO TM  
RIEJU  
SHERCO  
SUZUKI  
YAMAHA

**STREET**  
APRILIA  
CAGIVA  
HONDA  
KAWASAKI  
KTM  
SUZUKI  
YAMAHA

**ATV-UTV**  
CAN-AM  
GAS GAS  
HONDA  
KAWASAKI  
KTM  
POLARIS  
SUZUKI  
YAMAHA

**PWC**  
KAWASAKI  
POLARIS  
SEA DOO  
YAMAHA

**SNOW**  
ARCTIC CAT  
KAWASAKI  
LYNX  
MOTO-SKI  
POLARIS  
SKI DOO  
YAMAHA

**MOPED & SCOOTER**

**MISC. TECH. SPECIAL**

**KTM**

<b>DIRT</b> KTM 250 SX 2-Stroke Please Note: Nikasil Piston Size	<b>Piston Kit</b> 01.6317.A 01.6317.B 01.6317.C '96-99	<b>Size (mm)</b> 67.44 67.45 67.46	<b>Ring Set</b> 02.6316 02.6316 02.6316 '96-99	<b>Crank Bearing &amp; Seal Kit</b> 23.CBS63001 '90-99 03.6320 '00-02 23.CBS63004 '03-23	<b>Con. Rod Kit</b> 03.6311 '90-99 03.6320 '00-02 03.6323 '03-23	<b>Complete</b> 34.6310 '90-99 34.6320 '00-02 34.6323 '03-04 34.6325 '05-06 34.6327 '07-16 34.6317 '17-22						
Please Note: Nikasil Piston Size -01.6319 Forged Piston -01.6320 Cast Piston	01.6319.A 01.6319.B 01.6319.C 01.6320.D '00-02	66.34 66.35 66.36 66.37	02.6320 02.6320 02.6320 02.6320 '00-02	<b>Bearing</b> 23.NJ207ECS '97-23 Left 23.62206C4 '97-02 Right 23.6232X2 '03-23 Right	<b>S/E Bearing</b> 21.6320 '90-23	34.6327 '07-16 34.6317 '17-22						
Please Note: Nikasil Piston Size -01.6324 is 2 Ring Design -Molycoated Skirt -Fuel Injection from 2023 !	01.6343.A 01.6343.B 01.6343.C 01.6343.D '03-23	66.34 66.35 66.36 66.37	02.6324 02.6324 02.6324 02.6324 '03-23	<b>Oilseal Set</b> 42.6320 '90-23	<b>B/E Bearing</b> 22.243017 '90-02 22.243017F '03-23	35.6310 '90-99 35.6218 '00-02 35.6323 '03-04 35.6325 '05-06 35.6327 '07-16 35.6317 '17-19 35.6320 '20-22	<b>Top-End</b> 35.6310 '90-99 35.6218 '00-02 35.6323 '03-04 35.6325 '05-06 35.6327 '07-16 35.6317 '17-19 35.6320 '20-22	<b>Head &amp; Base</b> 36.6307 '07-16 36.6317 '17-22	<b>Ignition Cover Gasket</b> 19.G96394 '94-99 19.G96300 '00-02 19.G96303 '03-16 19.G96317 '17	<b>Crankpin</b> 06.2459.6 '90-23	<b>Pin</b> 04.1856 '00-23	<b>Clips</b> 05.1815 '96-99 05.1812 '00-23

Footnotes: \* Bearings Only \*\* Rubbers included

<b>Air Filter</b> 52.63090 '90-97 52.62098 '98-03 52.62004 '04-06 52.62007 '07-09 52.62010 '10 52.62011 '11-16 52.62016 '17-22 52.62023 '23	<b>Basket</b> 17.5305 '88-99 17.6323F '03-12  <b>Spring Kit</b> 17.CS63011 '96-12  <b>Inner Cover / Case Gasket</b> 19.G6323 '03-14  <b>Cover Gasket</b> 19.G6320 '90-02 19.G6324 '03-16 19.G6317 '17-22	<b>Complete Plate Set</b> 16.CPS63094 '94-95 16.CPS63096 '96-12 16.CPS64012 '13-23  <b>Friction Set</b> 16.S53014 '91-12 16.S53011 '13-23  <b>Steel Set</b> 16.S53015 '94-12 16.S53029 '13-23	<b>F/W Bearing</b> 23.S110063 '94-99 23.S110081 '00-02 23.S114002 '03-23  <b>R/W Bearing</b> 23.S112073 '94-22 23.S160023 '23  <b>F/W Spacer Kit</b> 26.710086 '94-99 26.710089 '00-02 26.710087 '03-14 26.710103 '15-23	<b>Frontbrake Disc</b> 37.BD16290 '90-23  <b>Rearbrake Disc</b> 37.BD26190 '90-23  <b>Front Pad Set</b> 37.102202 '94-23 37.102202BX '94-23 Box of 10  <b>Rear Pad Set</b> 37.204202 '94-02 37.204202BX '94-02 Box of 10 37.202302 '03-14 37.202302BX '03-23 Box of 10  <b>Steering Bearing</b> 24.110026 '94-22	<b>Front Sprocket</b> 07.FS62093-12 07.FS62093-13 07.FS62093-14 07.FS62093-15 '91-23  <b>7075-T6 Alloy Rear Sprocket</b> 07.RA62090-48 07.RA62090-49 07.RA62090-50 07.RA62090-51 07.RA62090-52 '90-23  <b>UltraLight Steel Rear Sprocket</b> 07.RS62090R-48 07.RS62090R-49 07.RS62090R-50 07.RS62090R-51 07.RS62090R-52 '90-23  <b>Sprocket Bolt Set</b> 07.SBSM825 '90-23	<b>Chain</b> 07.RC520120C '90-23 MX 07.RC520120CG '90-23 MX Gold 07.RC520120XC '90-23 X-Ring 07.RC520120XCG '90-23 X-Ring Gold  <b>Countershaft Seal Kit</b> 26.640004 '94-02 26.640003 '03-16 26.640001 '17-23  <b>Lower Chain Roller</b> 33.0003 '94-02  <b>Upper Chain Roller</b> 33.0003 '94-07	<b>Swingarm</b> 26.210087 '94-95 26.210088 '96-02 26.210168 '03-16 26.210125 '17-23  <b>Linkage</b> 26.110130 '94-97 26.110180 '12-22  <b>Upper</b> 26.350059 '02-11 26.450068 '12-23  <b>Lower</b> 26.410024 '94-97 26.410089 '98-11 26.450066 '12-22	<b>Seal &amp; Wiper</b> 40.S4352.99P '00-02 40.S485789 '03-14  <b>Oil Seal Set</b> 40.F4352.99P '00-02 40.F4857.89 '03-14  <b>Dust Seal Set</b> 40.F4353.4DP '00-02 40.F4857.8D '03-14  <b>Bushing Set</b> 39.160053 '00-01 39.160077 '03-04 39.160054 '05-07 39.160073 '08-11 39.160082 '12-14 39.160122 '15-16 39.160128 '17  <b>Rear Shock Seal Head Kit</b> 26.810119 '99-11 26.810127 '12-20
<b>Main Jet</b> 45.100-225 '96-16 Keihin 47.090-580 '17-22 Mikuni	<b>Pilot Jet</b> 46.040-085 '96-16 Keihin 49.010-045 '17-22 Mikuni	<b>Carburetor Rebuild Kit</b> 55.10516 '00-01 55.10514 '02-16 16.950000 '06-16 16.950014 '17-22	<b>Throttle Cable</b> 53.110046 '97-16 53.112059 '17-18 53.112070 '19-20 53.112087 '21-22	<b>Water Pump Rebuild Kit</b> 57.6314 '94-02 57.6324 '03-16 57.6317 '17	<b>Master Cylinder Rebuild Kit</b> 16.940002 '99-03 16.940001 '04-05 16.940000 '06-22	<b>Slave Cylinder Rebuild Kit</b> 16.950008 '00-05 16.950000 '06-16 16.950014 '17-22	<b>Front Caliper Rebuild Kit</b> 37.63050 '03-23 37.63048 '09-23  <b>Rear Caliper Rebuild Kit</b> 37.63050 '01-02 37.63048 '03-22  <b>Front Master Cylinder Rebuild Kit</b> 37.910025 '94-99 37.910023 '00-04 37.910024 '05-08 37.910026 '09-13 37.910035 '14-23  <b>Rear Master Cylinder Rebuild Kit</b> 37.910028 '03-11 37.910030 '12-23  <b>Brake Pedal Rebuild Kit</b> 37.RBPK002 '94-03 37.RBPK001 '04-16 37.RBPK003 '17	

**DIRT**  
APRILIA  
BETA  
BMW  
GAS GAS  
HONDA  
HUSABERG  
HUSQVARNA  
KAWASAKI  
KTM  
MOTO TM  
RIEJU  
SHERCO  
SUZUKI  
YAMAHA

**STREET**  
APRILIA  
CAGIVA  
HONDA  
KAWASAKI  
KTM  
SUZUKI  
YAMAHA

**ATV-UTV**  
CAN-AM  
GAS GAS  
HONDA  
KAWASAKI  
KTM  
POLARIS  
SUZUKI  
YAMAHA

**PWC**  
KAWASAKI  
POLARIS  
SEA DOO  
YAMAHA

**SNOW**  
ARCTIC CAT  
KAWASAKI  
LYNX  
MOTO-SKI  
POLARIS  
SKI DOO  
YAMAHA

**MOPED & SCOOTER**

**MISC. TECH. SPECIAL**





**KTM**

**DIRT**

APRILIA  
BETA  
BMW  
GAS GAS  
HONDA  
HUSABERG  
HUSQVARNA  
KAWASAKI  
KTM  
MOTO TM  
RIEJU  
SHERCO  
SUZUKI  
YAMAHA

KTM 250 EXC 2-Stroke	Piston Kit	Size (mm)	Ring Set	Crank Bearing & Seal Kit	Con. Rod Kit	Complete			
Please Note: Nikasil Piston Size	01.6317.A 01.6317.B 01.6317.C '96-99	67.44 67.45 67.46	02.6316 02.6316 02.6316 '96-99	23.CBS63001 '90-99 03.6320 '00-03 23.CBS63004 '04-17	03.6311 '90-99 03.6320 '00-03 03.6323 '04-17	34.6310 '90-99 34.6320 '00-03 34.6323 '04 34.6325 '05-06 34.6327 '07 34.6328 '08-16 34.6317 '17			
Please Note: Nikasil Piston Size -Forged Piston	01.6322.A 01.6322.B 01.6322.C '00-05	66.34 66.35 66.36	02.7307 02.7307 02.7307 '00-05	<b>Bearing</b> 23.NJ207ECS '97-17 Left 23.62206C4 '97-03 Right 23.6232X2 '04-17 Right	<b>S/E Bearing</b> 21.6320 '90-17				
Please Note: Nikasil Piston Size -Molycoated Skirt	01.6343.A 01.6343.B 01.6343.C 01.6343.D '06-17	66.34 66.35 66.36 66.37	02.6324 02.6324 02.6324 02.6324 '06-17	<b>Oilseal Set</b> 42.6320 '90-17	<b>B/E Bearing</b> 22.243017 '90-02 22.243017F '03-17	<b>Top-End</b> 35.6310 '90-99 35.6218 '00-03 35.6323 '04 35.6325 '05-06 35.6327 '07-16 35.6317 '17			
			<b>Pin</b> 04.1844 '96-99 04.1853.4 '00-05 04.1856 '06-17		<b>Crankpin</b> 06.2459.6 '90-17				
			<b>Clips</b> 05.1815 '96-99 05.1812 '00-17			<b>Head &amp; Base</b> 36.6307 '07-16 36.6317 '17			
						<b>Ignition Cover Gasket</b> 19.G96394 '94-99 19.G96300 '00-03 19.G96303 '04-07 19.G96308 '08-16 19.G96317 '17			

Footnotes: \* Bearings Only \*\* Rubbers included

**DIRT**

APRILIA  
BETA  
BMW  
GAS GAS  
HONDA  
HUSABERG  
HUSQVARNA  
KAWASAKI  
KTM  
MOTO TM  
RIEJU  
SHERCO  
SUZUKI  
YAMAHA

Air Filter	Basket	Complete Plate Set	F/W Bearing	Frontbrake Disc	Front Sprocket	Chain	Swingarm	Seal & Wiper
52.63090 '90-97 52.62098 '98-03 52.62004 '04-07 52.62007 '08-09 52.62010 '10-11 52.62011 '12-16 52.62016 '17	17.5305 '88-99 17.6323F '04-12 <b>Spring Kit</b> 17.CS63011 '96-12 <b>Inner Cover / Case Gasket</b> 19.G6323 '04-14 <b>Cover Gasket</b> 19.G6320 '90-03 19.G6324 '04-16 19.G6317 '17	16.CPS63096 '96-12 16.CPS64012 '13-17 <b>Friction Set</b> 16.S53014 '91-12 16.S53011 '13-17 <b>Steel Set</b> 16.S53015 '94-12 16.S53029 '13-17	23.S110061 '94-99 23.S110080 '00-02 23.S114002 '03-17 <b>R/W Bearing</b> 23.S112073 '94-17 <b>F/W Spacer Kit</b> 26.710085 '94-99 26.710088 '00-02 26.710087 '03-15 26.710103 '16-17 <b>R/W Spacer Kit</b> 26.710084 '94-16 26.710102 '17 <b>Steering Bearing</b> 24.110026 '94-17	37.BD16290 '90-17 <b>Rearbrake Disc</b> 37.BD26190 '90-17 <b>Front Pad Set</b> 37.102202 '94-17 37.102202BX '94-17 Box of 10 <b>Rear Pad Set</b> 37.204202 '94-03 37.204202BX '94-03 Box of 10 37.202302 '04-17 37.202302BX '04-17 Box of 10 <b>Front Caliper Rebuild Kit</b> 37.63047 '96-09 37.63046 '10-17 <b>Rear Caliper Rebuild Kit</b> 37.63048 '00 37.63050 '01-03 37.63048 '04-16 <b>Front Master Cylinder Rebuild Kit</b> 37.910025 '94-99 37.910023 '00-04 37.910022 '05 37.910024 '06-09 37.910026 '10-13 37.910035 '14-17 <b>Rear Master Cylinder Rebuild Kit</b> 37.910029 '94-99 37.910029 '01-03 37.910028 '04-12 37.910030 '13-17 <b>Brake Pedal Rebuild Kit</b> 37.RBPK002 '94-03 37.RBPK001 '04-16	07.FS62093-12 07.FS62093-13 07.FS62093-14 07.FS62093-15 '91-17 <b>7075-T6 Alloy Rear Sprocket</b> 07.RA62090-48 07.RA62090-50 07.RA62090-51 07.RA62090-52 '90-17 <b>UltraLight Steel Rear Sprocket</b> 07.RS62090R-48 07.RS62090R-49 07.RS62090R-50 07.RS62090R-51 07.RS62090R-52 '90-17 <b>Sprocket Bolt Set</b> 07.SBSM825 '90-17	07.RC520120C '90-17 MX 07.RC520120CG '90-17 MX Gold 07.RC520120XC '90-17 X-Ring 07.RC520120XCG '90-17 X-Ring Gold <b>Countershaft Seal Kit</b> 26.640004 '94-03 26.640003 '04-16 26.640001 '17 <b>Lower Chain Roller</b> 33.0003 '94-02 <b>Upper Chain Roller</b> 33.0003 '94-07	26.210088 '95-03 26.210168 '04-16 26.210125 '17 <b>Linkage</b> 26.110130 '94-97 <b>Upper</b> 26.350059 '02-17 <b>Lower</b> 26.410089 '98-16 26.450077 '17	40.S4352.99P '00-02 40.S4857.89 '03-15 <b>Oil Seal Set</b> 40.F4352.99P '00-02 40.F4857.89 '03-15 <b>Dust Seal Set</b> 40.F4353.4DP '00-02 40.F4857.8D '03-15 <b>Bushing Set</b> 39.160053 '00-01 39.160077 '03-04 39.160054 '05-07 39.160073 '08-11 39.160074 '12-15 <b>Rear Shock Seal Head Kit</b> 26.810119 '99-16 26.810120 '17

**STREET**

APRILIA  
CAGIVA  
HONDA  
KAWASAKI  
KTM  
SUZUKI  
YAMAHA

**ATV-UTV**

CAN-AM  
GAS GAS  
HONDA  
KAWASAKI  
KTM  
POLARIS  
SUZUKI  
YAMAHA

**PWC**

KAWASAKI  
POLARIS  
SEA DOO  
YAMAHA

**SNOW**

ARCTIC CAT  
KAWASAKI  
LYNX  
MOTO-SKI  
POLARIS  
SKI DOO  
YAMAHA

**MOPED & SCOOTER**

**MISC. TECH. SPECIAL**





**KTM**

**DIRT**  
APRILIA  
BETA  
BMW  
GAS GAS  
HONDA  
HUSABERG  
HUSQVARNA  
KAWASAKI  
KTM  
MOTO TM  
RIEJU  
SHERCO  
SUZUKI  
YAMAHA

KTM 250 EXC TPI  
2-Stroke  
Please Note:  
Nikasil Piston Size  
-Molycoated Skirt  
-Fuel Injection

<b>Piston Kit</b> 01.6343.A 01.6343.B 01.6343.C 01.6343.D '18-23	<b>Size</b> 66.34 66.35 66.36 66.37	<b>Ring Set</b> 02.6324 02.6324 02.6324 02.6324 '18-23	<b>Crank Bearing &amp; Seal Kit</b> 23.CBS63004 '18-23	<b>Con. Rod Kit</b> 03.6323 '18-23	<b>Complete</b> 34.6317 '18-22
		<b>Pin</b> 04.1856 '18-23	<b>Bearing</b> 23.NJ207ECS '18-23 Left 23.6232X2 '18-23 Right	<b>S/E Bearing</b> 21.6320 '18-23	<b>Top-End</b> 35.6317 '18-19 35.6320 '20-23
		<b>Clips</b> 05.1812 '18-23	<b>Oilseal Set</b> 42.6320 '18-23	<b>B/E Bearing</b> 22.243017F '18-23	<b>Head &amp; Base</b> 36.6317 '18-23
				<b>Crankpin</b> 06.2459.6 '18-23	

**STREET**  
APRILIA  
CAGIVA  
HONDA  
KAWASAKI  
KTM  
SUZUKI  
YAMAHA

KTM Freeride E-SX  
KTM Freeride E-XC  
KTM Freeride E-SM  
Electronic

--	--	--	--	--	--

**ATV-UTV**  
CAN-AM  
GAS GAS  
HONDA  
KAWASAKI  
KTM  
POLARIS  
SUZUKI  
YAMAHA

KTM Freeride E-SX  
KTM Freeride E-XC  
KTM Freeride E-SM  
Electronic

--	--	--	--	--	--

**PWC**  
KAWASAKI  
POLARIS  
SEA DOO  
YAMAHA

KTM Freeride 250 R  
2-Stroke  
Please Note:  
Nikasil Piston Size

<b>Piston Kit</b> 01.6343.A 01.6343.B 01.6343.C 01.6343.D '14-17	<b>Size</b> 66.34 66.35 66.36 66.37	<b>Ring Set</b> 02.6324 02.6324 02.6324 02.6324 '14-17	<b>Crank Bearing &amp; Seal Kit</b> 23.CBS63004 '14-17	<b>Con. Rod Kit</b> 03.6323 '14-17	<b>Complete</b> 34.6317 '18-22
		<b>Pin</b> 04.1856 '14-17	<b>Bearing</b> 23.NJ207ECS '14-17 Left 23.6232X2 '14-17 Right	<b>S/E Bearing</b> 21.6320 '14-17	<b>Top-End</b> 35.6317 '18-19 35.6320 '20-23
		<b>Clips</b> 05.1812 '14-17	<b>Oilseal Set</b> 42.6320 '14-17	<b>B/E Bearing</b> 22.243017F '14-17	<b>Head &amp; Base</b> 36.6317 '18-23
				<b>Crankpin</b> 06.2459.6 '14-17	

**SNOW**  
ARCTIC CAT  
KAWASAKI  
LYNX  
MOTO-SKI  
POLARIS  
SKI DOO  
YAMAHA

KTM Freeride 250 R  
2-Stroke  
Please Note:  
Nikasil Piston Size

--	--	--	--	--	--

**MOPED & SCOOTER**

KTM Freeride 250 R  
2-Stroke  
Please Note:  
Nikasil Piston Size

--	--	--	--	--	--

**MISC. TECH. SPECIAL**

KTM Freeride 250 R  
2-Stroke  
Please Note:  
Nikasil Piston Size

--	--	--	--	--	--

Footnotes: \* Bearings Only \*\* Rubbers included

**DIRT**  
APRILIA  
BETA  
BMW  
GAS GAS  
HONDA  
HUSABERG  
HUSQVARNA  
KAWASAKI  
KTM  
MOTO TM  
RIEJU  
SHERCO  
SUZUKI  
YAMAHA

**STREET**  
APRILIA  
CAGIVA  
HONDA  
KAWASAKI  
KTM  
SUZUKI  
YAMAHA

**ATV-UTV**  
CAN-AM  
GAS GAS  
HONDA  
KAWASAKI  
KTM  
POLARIS  
SUZUKI  
YAMAHA

**PWC**  
KAWASAKI  
POLARIS  
SEA DOO  
YAMAHA

**SNOW**  
ARCTIC CAT  
KAWASAKI  
LYNX  
MOTO-SKI  
POLARIS  
SKI DOO  
YAMAHA

**MOPED & SCOOTER**

**MISC. TECH. SPECIAL**

<b>Air Filter</b> 52.62016 '18-23	<b>Cover Gasket</b> 19.G6317 '18-23	<b>Complete Plate Set</b> 16.CPS64012 '18-23	<b>F/W Bearing</b> 23.S114002 '18-23	<b>Frontbrake Disc</b> 37.BD16290 '18-23	<b>Front Sprocket</b> 07.FS62093-12 07.FS62093-13 07.FS62093-14 07.FS62093-15 '18-23	<b>Chain</b> 07.RC520120C '18-23 MX 07.RC520120CG '18-23 MX Gold 07.RC520120XC '18-23 X-Ring 07.RC520120XCG '18-23 X-Ring Gold	<b>Swingarm</b> 26.210125 '18-23	<b>Rear Shock Seal Head Kit</b> 26.810120 '18-20
<b>Throttle Cable</b> 53.112071 '18-19 53.112072 '20-22 53.112091 '23	<b>Master Cylinder Rebuild Kit</b> 16.940000 '18-23	<b>Friction Set</b> 16.S53011 '18-23	<b>R/W Bearing</b> 23.S112073 '18-23	<b>Rearbrake Disc</b> 37.BD26190 '18-23	<b>7075-T6 Alloy Rear Sprocket</b> 07.RA62090-48 07.RA62090-49 07.RA62090-50 07.RA62090-51 07.RA62090-52 '18-23	<b>Countershaft Seal Kit</b> 26.640001 '18-23	<b>Upper</b> 26.350059 '18-23	
	<b>Slave Cylinder Rebuild Kit</b> 16.950014 '18-23	<b>Steel Set</b> 16.S53029 '18-23	<b>F/W Spacer Kit</b> 26.710103 '18-23	<b>Front Pad Set</b> 37.102202 '18-23	<b>Ultralight Steel Rear Sprocket</b> 07.RS62090R-48 07.RS62090R-49 07.RS62090R-50 07.RS62090R-51 07.RS62090R-52 '18-23		<b>Lower</b> 26.450077 '18-23	
			<b>R/W Spacer Kit</b> 26.710102 '18-23	<b>Rear Pad Set</b> 37.202302 '18-23	<b>Sprocket Bolt Set</b> 07.SBSM825 '18-23			
			<b>Steering Bearing</b> 24.110026 '18-23	<b>Front Caliper Rebuild Kit</b> 37.63046 '18-23				
				<b>Front Master Cylinder Rebuild Kit</b> 37.910035 '18-23				
				<b>Rear Master Cylinder Rebuild Kit</b> 37.910030 '18-23				
			<b>F/W Bearing</b> 23.S114006 '15-23	<b>Rearbrake Disc</b> 37.BD26190 '21-23	<b>Front Sprocket</b> 07.FS62093-12 07.FS62093-13 07.FS62093-14 07.FS62093-15 '15-23	<b>Chain</b> 07.RC520120C '15-23 MX 07.RC520120CG '15-23 MX Gold 07.RC520120XC '15-23 X-Ring 07.RC520120XCG '15-23 X-Ring Gold	<b>Swingarm</b> 26.210087 '15-23	
			<b>R/W Bearing</b> 23.S112073 '15-23	<b>Front Pad Set</b> 37.160202 '15-20	<b>Sprocket Bolt Set</b> 07.SBSM825 '15-23		<b>Lower</b> 26.350059 '15-19	
			<b>F/W Spacer Kit</b> 26.710105 '15-23	<b>Rear Pad Set</b> 37.160202BX '15-20 Box of 10 37.102202 '21-23 37.102202BX '21-23 Box of 10				
			<b>R/W Spacer Kit</b> 26.710084 '15-23	<b>Rear Pad Set</b> 37.289102 '15-20				
			<b>Steering Bearing</b> 24.110026 '15-23	<b>Rear Pad Set</b> 37.289102BX '15-20 Box of 10 37.202302 '21-23 37.202302BX '21-23 Box of 10				
<b>Main Jet</b> 45.100-225 '14-17 Keihin	<b>Inner Cover / Case Gasket</b> 19.G6323 '14-17	<b>Friction Set</b> 16.S53016 '14-17	<b>F/W Bearing</b> 23.S114006 '14-17	<b>Front Pad Set</b> 37.160202 '14-17	<b>Front Sprocket</b> 07.FS62093-12 07.FS62093-13 07.FS62093-14 07.FS62093-15 '14-17	<b>Chain</b> 07.RC520120C '14-17 MX 07.RC520120CG '14-17 MX Gold 07.RC520120XC '14-17 X-Ring 07.RC520120XCG '14-17 X-Ring Gold	<b>Swingarm</b> 26.210087 '15-17	<b>Seal &amp; Wiper</b> 40.S4352.99P '14-17
<b>Pilot Jet</b> 46.040-085 '14-17 Keihin	<b>Cover Gasket</b> 19.G6324 '14-17		<b>F/W Spacer Kit</b> 26.710105 '15-17	<b>Rear Pad Set</b> 37.160202BX '14-17	<b>Sprocket Bolt Set</b> 07.SBSM825 '14-17		<b>Lower</b> 26.350059 '15-17	<b>Oil Seal Set</b> 40.F4352.99P '14-17
<b>Carburetor Rebuild Kit</b> 55.10560 '15-17	<b>Master Cylinder Rebuild Kit</b> 16.910055 '15-17		<b>R/W Bearing</b> 23.S112073 '14-17	<b>Rear Pad Set</b> 37.289102 '14-17		<b>Countershaft Seal Kit</b> 26.640003 '14-17	<b>Lower</b> 26.350059 '15-17	<b>Dust Seal Set</b> 40.F4353.4DP '14-17
<b>Throttle Cable</b> 53.110046 '14-17	<b>Slave Cylinder Rebuild Kit</b> 16.950013 '15-17		<b>R/W Spacer Kit</b> 26.710084 '14-17	<b>Front Master Cylinder Rebuild Kit</b> 16.910055 '15-17				<b>Rear Shock Seal Head Kit</b> 26.810120 '15-17
<b>Water Pump Rebuild Kit</b> 57.6324 '15-17			<b>Steering Bearing</b> 24.110026 '14-17					



**KTM**

**DIRT**  
APRILIA  
BETA  
BMW  
GAS GAS  
HONDA  
HUSABERG  
HUSQVARNA  
KAWASAKI  
KTM  
MOTO TM  
RIEJU  
SHERCO  
SUZUKI  
YAMAHA

KTM Freeride 250 F 4-Stroke Please Note: Nikasil Piston Size -Std. Compression 12.8:1 -Forged Piston -Fuel Injection	<b>Piston Kit</b> 01.6333.A 01.6333.B 01.6333.C '18-20	<b>Size</b> 77.96 77.97 77.98	<b>Ring Set</b> 02.6333 02.6333 02.6333 '18-20	<b>CrankBearing &amp; Seal Kit</b> 23.CBS63017 '18-20	<b>Con. Rod Kit</b> 03.6337 '18-20	<b>Complete</b> 34.6316 '18-19	<b>Cam Chain</b> 31.6356 '18-20	<b>Valve Seal</b> 35.VS028 '18-20 4x
			<b>Clips</b> 05.1612C '18-20	<b>Bearing</b> 23.NJ206ECP-3 '18-20 2x	<b>Crankpin</b> 06.3056-2 '18-20	<b>Top-End</b> 35.6316 '18-20	<b>Valve Shim Assortment</b> 29.VSA890 '18-20	
						<b>Head &amp; Base</b> 36.6316 '18-20	<b>Valve Shim Assortment</b> 29.VSA890-2 '18-20	
						<b>Ignition Cover Gasket</b> 19.G96316 '18-20		

**STREET**  
APRILIA  
CAGIVA  
HONDA  
KAWASAKI  
KTM  
SUZUKI  
YAMAHA

KTM 250 EXC Racing 4-Stroke -Forged Piston	<b>Piston Kit</b> 01.6301.200 '01-06	<b>Size</b> 77.00	<b>Ring Set</b> 02.6301.200 '01-06	<b>Bearing</b> 23.NJ206ECP-1 '01-06 2x	<b>Con. Rod Kit</b> 03.6520 '01-06	<b>Complete</b> 34.6301 '01-06	<b>Camshaft Bearing</b> 23.6201-2RS '01-06	
Replating or Cylinder Sleeving Required for Oversizes			<b>Clips</b> 05.2015 '01-06		<b>B/E Bearing</b> 22.354322F '01-06	<b>Top-End</b> 35.6301 '01-06		
					<b>Crankpin</b> 06.3564.7 '01-06	<b>Ignition Cover Gasket</b> 19.G96403 '02-05		

**ATV-UTV**  
CAN-AM  
GAS GAS  
HONDA  
KAWASAKI  
KTM  
POLARIS  
SUZUKI  
YAMAHA

--	--	--	--	--	--	--	--	--

**PWC**  
KAWASAKI  
POLARIS  
SEA DOO  
YAMAHA

--	--	--	--	--	--	--	--	--

**SNOW**  
ARCTIC CAT  
KAWASAKI  
LYNX  
MOTO-SKI  
POLARIS  
SKI DOO  
YAMAHA

--	--	--	--	--	--	--	--	--

**MOPED & SCOOTER**

--	--	--	--	--	--	--	--	--

**MISC. TECH. SPECIAL**

--	--	--	--	--	--	--	--	--

Footnotes: \* Bearings Only \*\* Rubbers included

**DIRT**  
APRILIA  
BETA  
BMW  
GAS GAS  
HONDA  
HUSABERG  
HUSQVARNA  
KAWASAKI  
KTM  
MOTO TM  
RIEJU  
SHERCO  
SUZUKI  
YAMAHA

<b>Oil Filter</b> 54.63652 '18-20 1-Pce. 54.63652-50 '18-20 50-Pcs.	<b>Cover Gasket</b> 19.G6316 '18-20	<b>Friction Set</b> 16.S53016 '18-20	<b>F/W Bearing</b> 23.S114006 '18-20	<b>Rearbrake Disc</b> 37.BD26111 '18-20	<b>Front Sprocket</b> 07.FS62093-12 07.FS62093-13 07.FS62093-14 07.FS62093-15 '18-20	<b>Chain</b> 07.RC520120C '18-20 MX 07.RC520120CG '18-20 MX Gold 07.RC520120XC '18-20 X-Ring 07.RC520120XCG '18-20 X-Ring Gold		
			<b>R/W Bearing</b> 23.S112073 '18-20	<b>Rear Pad Set</b> 37.289102 '18-20 37.289102BX '18-20 Box of 10	<b>Sprocket Bolt Set</b> 07.SBSM825 '18-20	<b>Countershaft Seal Kit</b> 26.640001 '18-20		
			<b>F/W Spacer Kit</b> 26.710105 '18-20					
			<b>R/W Spacer Kit</b> 26.710084 '18-20					
			<b>Steering Bearing</b> 24.110026 '18-20					

**STREET**  
APRILIA  
CAGIVA  
HONDA  
KAWASAKI  
KTM  
SUZUKI  
YAMAHA

<b>Air Filter</b> 52.62004 '02-06	<b>Spring Kit</b> 17.CS65041 '01-06	<b>Complete Plate Set</b> 16.CPS63004 '04-06	<b>F/W Bearing</b> 23.S114002 '04-06	<b>Frontbrake Disc</b> 37.BD16290 '01-06	<b>Front Sprocket</b> 07.FS62093-12 07.FS62093-13 07.FS62093-14 07.FS62093-15 '01-06	<b>Chain</b> 07.RC520120C '01-06 MX 07.RC520120CG '01-06 MX Gold 07.RC520120XC '01-06 X-Ring 07.RC520120XCG '01-06 X-Ring Gold	<b>Swingarm</b> 26.210168 '04-06	<b>Seal &amp; Wiper</b> 40.S4352.99P '01-02 40.S4857.89 '03-06
<b>Main Jet</b> 45.100-225 '01-06 Keihin	<b>Master Cylinder Rebuild Kit</b> 16.940001 '02-03 16.940004 '04	<b>Friction Set</b> 16.S53016 '04-06	<b>R/W Bearing</b> 23.S112073 '01-06	<b>Rearbrake Disc</b> 37.BD26190 '01-06		<b>Upper</b> 26.350059 '02-06	<b>Oil Seal Set</b> 40.F4352.99P '01-02 40.F4857.89 '03-06	
<b>Pilot Jet</b> 46.040-085 '01-06 Keihin	<b>Slave Cylinder Rebuild Kit</b> 16.950009 '02-05	<b>Steel Set</b> 16.S54009 '03-06	<b>F/W Spacer Kit</b> 26.710087 '04-05	<b>Front Pad Set</b> 37.102202 '01-06 37.102202BX '01-06	<b>7075-T6 Alloy Rear Sprocket</b> 07.RA62090-48 07.RA62090-49 07.RA62090-50 07.RA62090-51 07.RA62090-52 '01-06	<b>Lower</b> 26.410089 '01-06	<b>Dust Seal Set</b> 40.F4353.4DP '01-02 40.F4857.8D '03-06	
<b>Carburetor Rebuild Kit</b> 55.10515 '02-02 55.10521 '03-05			<b>R/W Spacer Kit</b> 26.710084 '04-05	<b>Rear Pad Set</b> 37.204202 '01-03 37.204202BX '01-03 Box of 10 37.202302 '04-06 37.202302BX '04-06 Box of 10			<b>Rear Shock Seal Head Kit</b> 26.810119 '01-06	
<b>Throttle Cable</b> 53.110044 '02 53.110043 '03-06			<b>Steering Bearing</b> 24.110026 '01-06	<b>Front Caliper Rebuild Kit</b> 37.63047 '96-05	<b>Sprocket Bolt Set</b> 07.SBSM825 '01-06			
<b>Oil Filter #1</b> 54.63655 '01-06 1-Pce. 54.63655-50 '01-06 50-Pcs.				<b>Rear Caliper Rebuild Kit</b> 37.63048 '00 37.63050 '01-03 37.63048 '04-05				
<b>Oil Filter #2</b> 54.64157 '01-06 1-Pce. 54.64157-50 '01-06 50-Pcs.				<b>Brake Pedal Rebuild Kit</b> 37.RBPK002 '01-03 37.RBPK001 '04-06				
<b>Water Pump Rebuild Kit</b> 57.6322 '02-05								

**ATV-UTV**  
CAN-AM  
GAS GAS  
HONDA  
KAWASAKI  
KTM  
POLARIS  
SUZUKI  
YAMAHA

--	--	--	--	--	--	--	--	--

**PWC**  
KAWASAKI  
POLARIS  
SEA DOO  
YAMAHA

--	--	--	--	--	--	--	--	--

**SNOW**  
ARCTIC CAT  
KAWASAKI  
LYNX  
MOTO-SKI  
POLARIS  
SKI DOO  
YAMAHA

--	--	--	--	--	--	--	--	--

**MOPED & SCOOTER**

--	--	--	--	--	--	--	--	--

**MISC. TECH. SPECIAL**

--	--	--	--	--	--	--	--	--



### KTM

#### DIRT

- APRILIA
- BETA
- BMW
- GAS GAS
- HONDA
- HUSABERG
- HUSQVARNA
- KAWASAKI
- KTM
- MOTO TM
- RIEJU
- SHERCO
- SUZUKI
- YAMAHA

Model	Piston Kit	Size (mm)	Ring Set	Crank Bearing & Seal Kit	Con. Rod Kit	Complete	Cam Chain	Valve	
KTM 250 SX-F 4-Stroke	01.6338.A 01.6338.B 01.6338.C	75.96 75.97 75.98	02.6338 02.6338 02.6338	23.CBS63006 '06-10 23.CBS63013 '13-15 23.CBS63016 '16-18 23.CBS63017 '19-23	03.6326 '06-12 03.6333 '13-15 03.6337 '16-22 03.6343 '23	34.6326 '06-12 34.6333 '13-15 34.6316 '16-22 34.6326 '06-12 35.6333 '13-15 35.6316 '16-22 35.6343 '23	31.6328 '09-12 31.6351 '13-15 31.6356 '16-22 31.6363 '23	28.6326-1 '06-12 Exhaust Titanium 28.6326-2 '06-12 Intake Titanium 28.6333-1 '13-22 Exhaust Titanium 28.6343-1 '23 Exhaust Titanium 28.6333-2 '13-23 Intake Titanium	
Please Note: Nikasil Piston Size -Std. Compression 12.8:1 -Forged Piston -Fuel Injection from 2011									
Please Note: Nikasil Piston Size -Std. Compression 13.9:1 -Forged Piston -Fuel Injection	01.6333.A 01.6333.B 01.6333.C	77.96 77.97 77.98	02.6333 02.6333 02.6333	23.NJ206ECP-3 '13-23 2x	22.303818F '06-12	35.6333 '06-12 35.6333 '13-15 35.6316 '16-22 35.6343 '23	29.VSA890 '06-23 29.VSA890-2 '06-23		
Please Note: Nikasil Piston Size -Std. Compression 14.4:1 -Forged Piston -Fuel Injection	01.6347.A 01.6347.B 01.6347.C	77.96 77.97 77.98	02.6347 02.6347 02.6347	Oilseal Set 42.6326 '06-10 42.6351 '13-15 42.6336 '16-18	06.3056 '13-15 06.3056-2 '16-22 06.3055.4 '23	36.6306 '06-12 36.6313 '13-15 36.6316 '16-22 36.6343 '23		TI-Steel Conversion Set 28.SES6327-1 '06-07 Exhaust 28.SES6329-1 '08-12 Exhaust 28.SIS6327-2 '06-07 Intake 28.SIS6329-2 '08-12 Intake 28.SES6333-1 '13-15 Exhaust 28.SIS6333-2 '13-15 Intake	
Please Note: Nikasil Piston Size -Std. Compression 14.5:1 -Forged Piston -Fuel Injection	01.6348.A 01.6348.B 01.6348.C	80.96 80.97 80.98	TBA TBA TBA	Oilseal 41.6-354240 '11 41.6-405561 '19-23					
Please Note: Nikasil Piston Size -High Compression 13.3:1 -Forged Piston -Fuel Injection from 2011	High Compression 01.6329.A 01.6329.B	Size 75.96 75.97	Ring Set 02.6336 02.6336						
				Pin 04.1640.9 '06-12 Clips 05.1612C '06-22				Valve Seal 35.VS028 '06-23 4x	

Footnotes: \* Bearings Only \*\* Rubbers included

Model	Air Filter	Basket	Complete Plate Set	F/W Bearing	Frontbrake Disc	Front Sprocket	Chain	Swingarm	Seal & Wiper
KTM 250 SX-F 4-Stroke	52.62004 '06 52.62007 '07-09 52.62010 '10 52.62011 '11-15 52.62016 '16-22 52.62023 '23	17.6326F * '06-12 Clutch Rubber Set 17.CRS1287-8 '06-12 Inner Hub 18.1337 '06-12 Pressure Plate 18.P1308 '06-12 Spring Kit 17.CS12002 '06-12 17.CS63051 '13-15 Cover Gasket 19.G6325 '06-12 19.G6351 '13-15 19.G6316 '16-22 Master Cylinder Rebuild Kit 16.940004 '06 16.940000 '07-15 16.940010 '16-22 Slave Cylinder Rebuild Kit 16.950009 '06 16.950002 '07-12 16.950001 '13-15 16.950014 '16-22 Water Pump Rebuild Kit 57.6325 '05-12 57.6323 '13-15 57.6316 '16-20	16.CPS63006 '06-12 16.CPS63011 '13-15 16.CPS63019 '19-23 Friction Set 16.S13013 '06-12 16.S53011 '13-15 16.S53016 '16-23 Steel Set 16.S13014 '06-12 16.S53029 '13-15 16.S53027 '16-23	23.S114002 '06-23 R/W Bearing 23.S112073 '06-22 23.S160023 '23 F/W Spacer Kit 26.710087 '06-14 26.710103 '15-23 R/W Spacer Kit 26.710084 '06-12 26.710102 '13-22 Steering Bearing 24.110026 '06-22	37.BD16290 '06-23 Rearbrake Disc 37.BD26190 '06-23 Front Pad Set 37.102202 '06-23 37.102202BX '06-23 Box of 10 Rear Pad Set 37.202302 '06-23 37.202302BX '06-23 Box of 10 Front Caliper Rebuild Kit 37.63047 '05-08 37.63046 '09-23 Rear Caliper Rebuild Kit 37.63048 '05-22 Front Master Cylinder Rebuild Kit 37.910024 '06-08 37.910026 '09-13 37.910035 '14-23 Rear Master Cylinder Rebuild Kit 37.910028 '06-11 37.910030 '12-23 Brake Pedal Rebuild Kit 37.RBPK001 '06-15 37.RBPK003 '16-17	07.FS62093-12 07.FS62093-13 07.FS62093-14 07.FS62093-15 '06-23 7075-T6 Alloy Rear Sprocket 07.RA62090-48 07.RA62090-49 07.RA62090-50 07.RA62090-51 07.RA62090-52 '06-23 UltraLight Steel Rear Sprocket 07.RS62090R-48 07.RS62090R-49 07.RS62090R-50 07.RS62090R-51 07.RS62090R-52 '06-23 Sprocket Bolt Set 07.SBSM825 '06-23	07.RC520120C '06-23 MX 07.RC520120CG '06-23 MX Gold 07.RC520120XC '06-23 X-Ring 07.RC520120XCG '06-23 X-Ring Gold Countershaft Seal Kit 26.640001 '06-23 Upper Chain Roller 33.0003 '06-07	26.210168 '06-15 26.210125 '16-23 Linkage 26.110180 '11-20 Upper 26.350059 '06-10 26.450068 '11-23 Lower 26.410089 '06-10 26.450066 '11-20	40.S4857.89 '06-14 Oil Seal Set 40.F4857.89 '06-14 Dust Seal Set 40.F4857.8D '06-14 Bushing Set 39.160054 '05-07 39.160073 '08-11 39.160082 '12-14 39.160122 '15-16 39.160128 '17 Rear Shock Seal Head Kit 26.810119 '06-10 26.810127 '11-20

#### DIRT

- APRILIA
- BETA
- BMW
- GAS GAS
- HONDA
- HUSABERG
- HUSQVARNA
- KAWASAKI
- KTM
- MOTO TM
- RIEJU
- SHERCO
- SUZUKI
- YAMAHA

#### STREET

- APRILIA
- CAGIVA
- HONDA
- KAWASAKI
- KTM
- POLARIS
- SUZUKI
- YAMAHA

#### ATV-UTV

- CAN-AM
- GAS GAS
- HONDA
- KAWASAKI
- KTM
- POLARIS
- SUZUKI
- YAMAHA

#### PWC

- KAWASAKI
- POLARIS
- SEA DOO
- YAMAHA

#### SNOW

- ARCTIC CAT
- KAWASAKI
- LYNX
- MOTO-SKI
- POLARIS
- SKI DOO
- YAMAHA

#### MOPED & SCOOTER

#### MISC. TECH. SPECIAL





**KTM**

**DIRT**  
APRILIA  
BETA  
BMW  
GAS GAS  
HONDA  
HUSABERG  
HUSQVARNA  
KAWASAKI  
KTM  
MOTO TM  
RIEJU  
SHERCO  
SUZUKI  
YAMAHA

**STREET**  
APRILIA  
CAGIVA  
HONDA  
KAWASAKI  
KTM  
SUZUKI  
YAMAHA

**ATV-UTV**  
CAN-AM  
GAS GAS  
HONDA  
KAWASAKI  
KTM  
POLARIS  
SUZUKI  
YAMAHA

**PWC**  
KAWASAKI  
POLARIS  
SEA DOO  
YAMAHA

**SNOW**  
ARCTIC CAT  
KAWASAKI  
LYNX  
MOTO-SKI  
POLARIS  
SKI DOO  
YAMAHA

**MOPED & SCOOTER**

**MISC. TECH. SPECIAL**

<p>KTM 250 EXC-F 4-Stroke Please Note: Nikasil Piston Size -Std. Compression 12.8:1 -Forged Piston</p>	<p><b>Piston Kit</b> 01.6338.A 01.6338.B 01.6338.C '07-11</p>	<p><b>SIZES (mm)</b> 75.96 75.97 75.98</p>	<p><b>Piston Parts</b> 02.6338 02.6338 02.6338 '07-13</p>	<p><b>Crankbearing &amp; Seal Kit</b> 23.CBS63013 '14-15 23.CBS63017 '16-23</p>	<p><b>Con. Rod Kit</b> 03.6326 '07-13 03.6333 '14-16 03.6337 '17-23</p>	<p><b>Complete</b> 34.6326 '07-13 34.6334 '14-16 34.6347 '17-19</p>	<p><b>Cam Chain</b> 31.6328 '09-13 31.6351 '14-16 31.6356 '17-23</p>	<p><b>Valve</b> 28.6326-1 '07-13 Exhaust Titanium 28.6326-2 '07-13 Intake Titanium 28.6333-1 '14-23 Exhaust Titanium 28.6333-2 '14-23 Intake Titanium</p>	<p><b>TI-Steel Conversion Set</b> 28.SES6327-1 '07 Exhaust 28.SES6329-1 '08-13 Exhaust 28.SIS6327-2 '07 Intake 28.SIS6329-2 '08-13 Intake 28.SES6334-1 '14-16 Exhaust 28.SIS6334-2 '14-16 Intake</p>	<p><b>Valve Seal</b> 35.VS028 '07-23 4x</p>
<p>Please Note: Nikasil Piston Size -Std. Compression 13.2:1 -Forged Piston -Fuel Injection</p>	<p>01.6338.A 01.6338.B 01.6338.C '12-13</p>	<p>75.96 75.97 75.98</p>	<p>02.6338 02.6338 02.6338 '07-13</p>	<p><b>Bearing</b> 23.NJ206 '07-13 2x 23.NJ206ECP-3 '14-23 2x</p>	<p><b>B/E Bearing</b> 22.303818F '07-13</p>	<p><b>Top-End</b> 35.6326 '07-13 35.6333 '14-16 35.6316 '17-19</p>	<p><b>Valve Shim Assortment</b> 29.VSA890 '07-23 29.VSA890-2 '07-23</p>	<p><b>Head &amp; Base</b> 36.6306 '07-13 36.6316 '17-19</p>	<p><b>Ignition Cover Gasket</b> 19.G96307 '07-11 19.G96311 '12-13 19.G96314 '14-16 19.G96316 '17-23</p>	
<p>Please Note: Nikasil Piston Size -Std. Compression 13.9:1 -Forged Piston -Fuel Injection</p>	<p>01.6333.A 01.6333.B 01.6333.C '14-23</p>	<p>77.96 77.97 77.98</p>	<p>02.6333 02.6333 02.6333 '14-23</p>	<p><b>Oilseal Set</b> 42.6351 '14-15 41.6-354240 '07-12 Right 41.6-405561 '16-23</p>	<p><b>Crankpin</b> 06.3053.6 '07-13 06.3056 '14-16 06.3056-2 '17-23</p>					
<p>Please Note: Nikasil Piston Size -High Compression 13.3:1 -Forged Piston -Fuel Injection from 2012</p>	<p><b>High Compression</b> 01.6329.A 01.6329.B '07-13</p>	<p>75.96 75.97</p>	<p>02.6336 02.6336 '07-13</p>	<p><b>Pin</b> 04.1640.9 '07-13</p>						
				<p><b>Clips</b> 05.1612C '06-23</p>						

Footnotes: \* Bearings Only \*\* Rubbers included

<p><b>Air Filter</b> 52.62004 '07 52.62007 '08-09 52.62010 '10-11 52.62011 '12-16 52.62016 '17-23</p>	<p><b>Basket</b> 17.6326F * '07-13 <b>Clutch Rubber Set</b> 17.CRS1287-8 '07-13 <b>Inner Hub</b> 18.1337 '07-13 <b>Pressure Plate</b> 18.P1308 '07-13 <b>Spring Kit</b> 17.CS12002 '07-13 <b>Cover Gasket</b> 19.G6325 '07-13 19.G6351 '14-16 19.G6316 '17-23 <b>Master Cylinder Rebuild Kit</b> 16.940000 '07-19 <b>Slave Cylinder Rebuild Kit</b> 16.950002 '07-13 16.950001 '14-16 16.950014 '17-19</p>	<p><b>Complete Plate Set</b> 16.CPS63006 '07-13 16.CPS64012 '14-23 <b>Friction Set</b> 16.S13013 '07-13 16.S53011 '14-23 <b>Steel Set</b> 16.S13014 '07-13 16.S53029 '14-23</p>	<p><b>F/W Bearing</b> 23.S114002 '07-23 <b>R/W Bearing</b> 23.S112073 '07-23 <b>F/W Spacer Kit</b> 26.710087 '07-15 26.710103 '16-23 <b>R/W Spacer Kit</b> 26.710084 '07-23 24.110026 '07-23</p>	<p><b>Frontbrake Disc</b> 37.BD16290 '07-23 <b>Rearbrake Disc</b> 37.BD26190 '07-23 <b>Front Pad Set</b> 37.102202 '07-23 37.102202BX '07-23 Box of 10 <b>Rear Pad Set</b> 37.202302 '07-23 37.202302BX '07-23 Box of 10 <b>Front Caliper Rebuild Kit</b> 37.63047 '07-10 37.63046 '11-23 <b>Rear Caliper Rebuild Kit</b> 37.63048 '07-16 <b>Front Master Cylinder Rebuild Kit</b> 37.910024 '07-10 37.910026 '11-13 37.910035 '14-23 <b>Rear Master Cylinder Rebuild Kit</b> 37.910028 '07-12 37.910030 '13-23 <b>Brake Pedal Rebuild Kit</b> 37.RBPK001 '07-16 37.RBPK003 '17</p>	<p><b>Front Sprocket</b> 07.FS62093-12 07.FS62093-13 07.FS62093-14 07.FS62093-15 '07-23 <b>7075-T6 Alloy Rear Sprocket</b> 07.RA62090-48 07.RA62090-49 07.RA62090-50 07.RA62090-51 07.RA62090-52 '07-23 <b>UltraLight Steel Rear Sprocket</b> 07.RS62090R-48 07.RS62090R-49 07.RS62090R-50 07.RS62090R-51 07.RS62090R-52 '07-23 <b>Sprocket Bolt Set</b> 07.SBSM825 '07-23</p>	<p><b>Chain</b> 07.RC520120C '07-23 MX 07.RC520120CG '07-23 MX Gold 07.RC520120XC '07-23 X-Ring 07.RC520120XCG '07-23 X-Ring Gold <b>Countershaft Seal Kit</b> 26.640001 '07-23 <b>Upper Chain Roller</b> 33.0003 '07</p>	<p><b>Swingarm</b> 26.210168 '07-16 26.210125 '17-23 <b>Upper</b> 26.350059 '07-23 <b>Lower</b> 26.410089 '07-16 26.450077 '17-23</p>	<p><b>Seal &amp; Wiper</b> 40.S4857.89 '07-15 <b>Oil Seal Set</b> 40.F4857.89 '07-15 <b>Dust Seal Set</b> 40.F4857.8D '07-15 <b>Bushing Set</b> 39.160054 '07 39.160073 '08 39.160054 '09-11 39.160074 '12-15 <b>Rear Shock Seal Head Kit</b> 26.810119 '07-16 26.810120 '17-20</p>
---	--	---	--	---	--	---	---	---

**DIRT**  
APRILIA  
BETA  
BMW  
GAS GAS  
HONDA  
HUSABERG  
HUSQVARNA  
KAWASAKI  
KTM  
MOTO TM  
RIEJU  
SHERCO  
SUZUKI  
YAMAHA

**STREET**  
APRILIA  
CAGIVA  
HONDA  
KAWASAKI  
KTM  
SUZUKI  
YAMAHA

**ATV-UTV**  
CAN-AM  
GAS GAS  
HONDA  
KAWASAKI  
KTM  
POLARIS  
SUZUKI  
YAMAHA

**PWC**  
KAWASAKI  
POLARIS  
SEA DOO  
YAMAHA

**SNOW**  
ARCTIC CAT  
KAWASAKI  
LYNX  
MOTO-SKI  
POLARIS  
SKI DOO  
YAMAHA

**MOPED & SCOOTER**

**MISC. TECH. SPECIAL**





**KTM**

**DIRT**

- APRILIA
- BETA
- BMW
- GAS GAS
- HONDA
- HUSABERG
- HUSQVARNA
- KAWASAKI
- KTM**
- MOTO TM
- RIEJU
- SHERCO
- SUZUKI
- YAMAHA

KTM 300 SX  
2-Stroke  
Please Note:  
Nikasil Piston Size  
-Forged Piston  
-Fuel Injection

<b>Piston Kit</b> 01.6388.A 01.6388.B 01.6388.C '23	<b>SIZES (mm)</b> 71.94 71.95 71.96	<b>Ring Set</b> 02.6396 02.6396 02.6396 '23 <b>Clips</b> 05.1812 '23	<b>CrankBearing &amp; Seal Kit</b> 23.CBS63004 '23 <b>Bearing</b> 23.NJ207ECS '23 Left 23.6232X2 '23 Right <b>Oilseal Set</b> 42.6320 '23	<b>Con. Rod Kit</b> 03.6323 '23 <b>S/E Bearing</b> 21.6320 '23 <b>B/E Bearing</b> 22.243017F '23 <b>Crankpin</b> 06.2459.6 '23
---	--	---	---	---

**STREET**

- APRILIA
- CAGIVA
- HONDA
- KAWASAKI
- KTM
- SUZUKI
- YAMAHA

**ATV-UTV**

- CAN-AM
- GAS GAS
- HONDA
- KAWASAKI
- KTM
- POLARIS
- SUZUKI
- YAMAHA

**PWC**

- KAWASAKI
- POLARIS
- SEA DOO
- YAMAHA

**SNOW**

- ARCTIC CAT
- KAWASAKI
- LYNX
- MOTO-SKI
- POLARIS
- SKI DOO
- YAMAHA

**MOPED & SCOOTER**

**MISC. TECH. SPECIAL**

**DIRT**

- APRILIA
- BETA
- BMW
- GAS GAS
- HONDA
- HUSABERG
- HUSQVARNA
- KAWASAKI
- KTM**
- MOTO TM
- RIEJU
- SHERCO
- SUZUKI
- YAMAHA

**STREET**

- APRILIA
- CAGIVA
- HONDA
- KAWASAKI
- KTM
- SUZUKI
- YAMAHA

**ATV-UTV**

- CAN-AM
- GAS GAS
- HONDA
- KAWASAKI
- KTM
- POLARIS
- SUZUKI
- YAMAHA

**PWC**

- KAWASAKI
- POLARIS
- SEA DOO
- YAMAHA

**SNOW**

- ARCTIC CAT
- KAWASAKI
- LYNX
- MOTO-SKI
- POLARIS
- SKI DOO
- YAMAHA

**MOPED & SCOOTER**

**MISC. TECH. SPECIAL**

<b>Air Filter</b> 52.62023 '23	<b>Complete Plate Set</b> 16.CPS64012 '23 <b>Friction Set</b> 16.S53011 '23 <b>Steel Set</b> 16.S53029 '23	<b>F/W Bearing</b> 23.S114002 '23 <b>F/W Spacer Kit</b> 26.710103 '23 <b>R/W Bearing</b> 23.S160023 '23	<b>Frontbrake Disc</b> 37.BD16290 '23 <b>Rearbrake Disc</b> 37.BD26190 '23 <b>Front Pad Set</b> 37.102202 '23 37.102202BX '23 Box of 10 <b>Rear Pad Set</b> 37.202302 '23 37.202302BX '23 Box of 10 <b>Front Caliper Rebuild Kit</b> 37.63046 '23 <b>Front Master Cylinder Rebuild Kit</b> 37.910035 '23 <b>Rear Master Cylinder Rebuild Kit</b> 37.910030 '23	<b>Front Sprocket</b> 07.FS62093-12 07.FS62093-13 07.FS62093-14 07.FS62093-15 '23 <b>7075-T6 Alloy Rear Sprocket</b> 07.RA62090-48 07.RA62090-49 07.RA62090-50 07.RA62090-51 07.RA62090-52 '23 <b>Ultralight Steel Rear Sprocket</b> 07.RS62090R-48 07.RS62090R-49 07.RS62090R-50 07.RS62090R-51 07.RS62090R-52 '23 <b>Sprocket Bolt Set</b> 07.SBSM825 '23	<b>Chain</b> 07.RC520120C '23 MX 07.RC520120CG '23 MX Gold 07.RC520120XC '23 X-Ring 07.RC520120XCG '23 X-Ring Gold <b>Countershaft Seal Kit</b> 26.640001 '23	<b>Swingarm</b> 26.210125 '23 <b>Upper</b> 26.450068 '23
--------------------------------------	--	---	--	---	--	---

Footnotes: \* Bearings Only \*\* Rubbers included

**KTM**

**DIRT**  
APRILIA  
BETA  
BMW  
GAS GAS  
HONDA  
HUSABERG  
HUSQVARNA  
KAWASAKI  
**KTM**  
MOTO TM  
RIEJU  
SHERCO  
SUZUKI  
YAMAHA

**STREET**  
APRILIA  
CAGIVA  
HONDA  
KAWASAKI  
**KTM**  
SUZUKI  
YAMAHA

**ATV-UTV**  
CAN-AM  
GAS GAS  
HONDA  
KAWASAKI  
**KTM**  
POLARIS  
SUZUKI  
YAMAHA

**PWC**  
KAWASAKI  
POLARIS  
SEA DOO  
YAMAHA

**SNOW**  
ARCTIC CAT  
KAWASAKI  
LYNX  
MOTO-SKI  
POLARIS  
SKI DOO  
YAMAHA

**MOPED & SCOOTER**

**MISC. TECH. SPECIAL**

KTM 300 EXC 2-Stroke Please Note: Nikasil Piston Size -Forged Piston		<b>Piston Kit</b> 01.6396.A 01.6396.B 01.6396.C '96-03	<b>Size (mm)</b> 71.94 71.95 71.96	<b>Ring Set</b> 02.6396 02.6396 02.6396 '96-03	<b>CrankBearing &amp; Seal Kit</b> 23.CBS63001 '97-03 23.CBS63004 '04-17	<b>Con. Rod Kit</b> 03.6311 '90-03 03.6323 '04-17	<b>Complete</b> 34.6340 '90-03 34.6344 '04 34.6345 '05-07 34.6348 '08-16 34.6317 '17			
Please Note: Nikasil Piston Size		01.6394.A 01.6394.B 01.6394.C '04-16	71.94 71.95 71.96	02.6394 02.6394 02.6394 '04-16	<b>Bearing</b> 23.NJ207ECS '97-17 Left 23.62206C4 '97-03 Right 23.6232X2 '04-17 Right	<b>S/E Bearing</b> 21.6320 '90-17	<b>B/E Bearing</b> 22.243017F '90-17	<b>Top-End</b> 35.6340 '90-03 35.6344 '04 35.6345 '05-07 35.6348 '08-16 35.6347 '17	<b>Head &amp; Base</b> 36.6308 '08-16 36.6327 '17	<b>Ignition Cover Gasket</b> 19.G96300 '94-03 19.G96303 '04-07 19.G96308 '08-16 19.G96317 '17
Please Note: Nikasil Piston Size -Forged Piston		01.6387.A 01.6387.B 01.6387.C '17	71.94 71.95 71.96	02.6396 02.6396 02.6396 '17-21	<b>Oilseal Set</b> 42.6320 '90-17	<b>Crankpin</b> 06.2459.6 '90-17	<b>Pin</b> 04.1852.7 '96-03 04.1852.7 '17	<b>Clips</b> 05.1812 '96-03 05.1815 '04-16 05.1812 '17		

Footnotes: \* Bearings Only \*\* Rubbers included

<b>Air Filter</b> 52.63090 '90-97 52.62098 '98-03 52.62004 '04-07 52.62007 '08-09 52.62010 '10-11 52.62011 '12-16 52.62016 '17	<b>Basket</b> 17.6323F '04-12	<b>Complete Plate Set</b> 16.CPS63094 '94-95 16.CPS63096 '96-12 16.CPS64012 '13-17	<b>F/W Bearing</b> 23.S110061 '94-99 23.S110080 '00-02 23.S114002 '03-17	<b>Frontbrake Disc</b> 37.BD16290 '91-17	<b>Front Sprocket</b> 07.FS62093-12 07.FS62093-13 07.FS62093-14 07.FS62093-15 '90-17	<b>Chain</b> 07.RC520120C '90-17 MX 07.RC520120CG '90-17 MX Gold 07.RC520120XC '90-17 X-Ring 07.RC520120XCG '90-17 X-Ring Gold	<b>Swingarm</b> 26.210087 '94-95 26.210088 '96-03 26.210168 '04-16 26.210125 '17	<b>Seal &amp; Wiper</b> 40.S4352.99P '00-02 40.S4857.89 '03-15	<b>Oil Seal Set</b> 40.F4352.99P '00-02 40.F4857.89 '03-15	<b>Linkage</b> 26.110130 '94-97	<b>Dust Seal Set</b> 40.F4353.4DP '00-02 40.F4857.8D '03-15	
<b>Main Jet</b> 45.100-225 '96-16 Keihin 47.090-580 '17 Mikuni	<b>Inner Cover / Case Gasket</b> 19.G6323 '04-17	<b>Friction Set</b> 16.S53014 '91-12 16.S53011 '13-17	<b>R/W Bearing</b> 23.S112073 '94-17	<b>Front Pad Set</b> 37.102202 '94-17 37.102202BX '94-17 Box of 10	<b>7075-T6 Alloy Rear Sprocket</b> 07.RA62090-48 07.RA62090-49 07.RA62090-50 07.RA62090-51 07.RA62090-52 '90-17	<b>Countershaft Seal Kit</b> 26.640004 '94-03 26.640003 '04-16 26.640001 '17	<b>Upper</b> 26.350059 '02-17	<b>Lower Chain Roller</b> 33.0003 '94-02	<b>Lower</b> 26.410024 '94-97 26.410089 '98-16 26.450077 '17	<b>Bushing Set</b> 39.160053 '00-01 39.160077 '03-05 39.160054 '06-07 39.160073 '08-11 39.160074 '12-15 + 17	<b>Rear Shock Seal Head Kit</b> 26.810119 '99-16 26.810120 '17	
<b>Pilot Jet</b> 46.040-085 '96-16 Keihin 49.010-045 '17 Mikuni	<b>Cover Gasket</b> 19.G6320 '90-03 19.G6324 '04-16 19.G6317 '17	<b>Steel Set</b> 16.S53015 '91-12 16.S53029 '13-17	<b>F/W Spacer Kit</b> 26.710085 '94-99 26.710088 '00-02 26.710087 '03-15 26.710103 '16-17	<b>Rear Pad Set</b> 37.204202 '94-03 37.204202BX '94-03 Box of 10 37.202302 '04-17 Box of 10	<b>UltraLight Steel Rear Sprocket</b> 07.RS62090R-48 07.RS62090R-49 07.RS62090R-50 07.RS62090R-51 07.RS62090R-52 '90-17	<b>Upper Chain Roller</b> 33.0003 '94-07		<b>Sprocket Bolt Set</b> 07.SBSM825 '90-17				
<b>Carburetor Rebuild Kit</b> 55.10517 '00-03 55.10514 '04-16	<b>Master Cylinder Rebuild Kit</b> 16.940002 '99-03 16.940001 '04-05 16.940000 '06-16 16.940010 '17		<b>R/W Spacer Kit</b> 26.710084 '94-17	<b>Front Caliper Rebuild Kit</b> 37.63047 '96-09 37.63046 '10-17								
<b>Throttle Cable</b> 53.110046 '97-16 53.112059 '17	<b>Slave Cylinder Rebuild Kit</b> 16.950008 '00-05 16.950000 '06-16 16.950014 '17		<b>Steering Bearing</b> 24.110026 '94-17	<b>Rear Caliper Rebuild Kit</b> 37.63050 '01-03 37.63048 '04-16								
<b>Water Pump Rebuild Kit</b> 57.6314 '94-03 57.6324 '04-16 57.6317 '17				<b>Front Master Cylinder Rebuild Kit</b> 37.910025 '94-99 37.910023 '00-04 37.910022 '05 37.910024 '06-09 37.910026 '10-13 37.910035 '14-17								
				<b>Rear Master Cylinder Rebuild Kit</b> 37.910028 '04-12 37.910030 '13-17								
				<b>Brake Pedal Rebuild Kit</b> 37.RBPK002 '94-03 37.RBPK001 '04-16 37.RBPK003 '17								

**DIRT**  
APRILIA  
BETA  
BMW  
GAS GAS  
HONDA  
HUSABERG  
HUSQVARNA  
KAWASAKI  
**KTM**  
MOTO TM  
RIEJU  
SHERCO  
SUZUKI  
YAMAHA

**STREET**  
APRILIA  
CAGIVA  
HONDA  
KAWASAKI  
**KTM**  
SUZUKI  
YAMAHA

**ATV-UTV**  
CAN-AM  
GAS GAS  
HONDA  
KAWASAKI  
**KTM**  
POLARIS  
SUZUKI  
YAMAHA

**PWC**  
KAWASAKI  
POLARIS  
SEA DOO  
YAMAHA

**SNOW**  
ARCTIC CAT  
KAWASAKI  
LYNX  
MOTO-SKI  
POLARIS  
SKI DOO  
YAMAHA

**MOPED & SCOOTER**

**MISC. TECH. SPECIAL**





**DIRT**  
APRILIA  
BETA  
BMW  
GAS GAS  
HONDA  
HUSABERG  
HUSQVARNA  
KAWASAKI  
KTM  
MOTO TM  
RIEJU  
SHERCO  
SUZUKI  
YAMAHA

**STREET**  
APRILIA  
CAGIVA  
HONDA  
KAWASAKI  
KTM  
SUZUKI  
YAMAHA

**ATV-UTV**  
CAN-AM  
GAS GAS  
HONDA  
KAWASAKI  
KTM  
POLARIS  
SUZUKI  
YAMAHA

**PWC**  
KAWASAKI  
POLARIS  
SEA DOO  
YAMAHA

**SNOW**  
ARCTIC CAT  
KAWASAKI  
LYNX  
MOTO-SKI  
POLARIS  
SKI DOO  
YAMAHA

**MOPED  
&  
SCOOTER**

**MISC.  
TECH.  
SPECIAL**

**KTM**

KTM 350 EXC-F 4-Stroke Please Note: Nikasil Piston Size -Std. Compression 12.3:1 -Forged Piston -Fuel Injection		<b>Piston Kit</b> 01.6362.A 01.6362.B 01.6362.C '12-16	<b>Size (mm)</b> 87.96 87.97 87.98	<b>Ring Set</b> 02.6351 02.6351 02.6351 '12-23	<b>Crank Bearing &amp; Seal Kit</b> 23.CBS63013 '12-15 23.CBS63017 '16-23	<b>Con. Rod Kit</b> 03.6351 '12-13 03.6363 '14-16 03.6366 '17-23	<b>Complete</b> 34.6312 '12-16 34.6337 '17-19	<b>Cam Chain</b> 31.6351 '12-16 31.6356 '17-23	<b>Valve</b> 28.6351-1 '12-19 2x Exhaust Titanium 28.6351-2 '12-19 2x Intake Titanium 28.6362-1 '20-23 2x Exhaust Steel 28.6362-2 '20-23 2x Intake Steel	<b>Valve Shim Assortment</b> 29.VSA890 '12-23 29.VSA890-2 '12-23	<b>Head &amp; Base</b> 36.6311 '12-13 36.6314 '14-15 36.6326 '17-19 36.6319 '20-23	<b>Ignition Cover Gasket</b> 19.G96311 '12 19.G96314 '13-16 19.G96316 '17-23	<b>TI-Steel Conversion Set</b> 28.SES6353-1 '12-16 Exhaust 28.SIS6353-2 '12-16 Intake	<b>Valve Seal</b> 35.VS029 '12-23 4x	
Please Note: Nikasil Piston Size -Std. Compression 12.3:1 -Forged Piston -Fuel Injection		01.6367.A 01.6367.B 01.6367.C '17-19	87.96 87.97 87.98	02.6351 02.6351 02.6351 '12-23	23.NJ206ECP-3 '12-23 2x	<b>B/E Bearing</b> 22.324020F '12-13			<b>Master Cylinder Rebuild Kit</b> 16.940000 '12-23						
Please Note: Nikasil Piston Size -Std. Compression 13.5:1 -Forged Piston -Fuel Injection		01.6351.A 01.6351.B 01.6351.C '20-23	87.96 87.97 87.98	02.6351 02.6351 02.6351 '12-23		<b>Crankpin</b> 06.3259.9 '12-13 <b>Oilseal</b> 06.3259.9-1 '17-23			<b>Slave Cylinder Rebuild Kit</b> 16.950001 '12-16 16.9500014 '17-23						
				<b>Pin</b> 04.1844.4 '12-23 <b>Clips</b> 05.1812 '12-23											

Footnotes: \* Bearings Only \*\* Rubbers included

<b>Air Filter</b> 52.62011 '12-16 52.62016 '17-23	<b>Cover Gasket</b> 19.G6351 '12-16 19.G6316 '17-23	<b>Complete Plate Set</b> 16.CPS64012 '12-23	<b>F/W Bearing</b> 23.S114002 '12-23	<b>Frontbrake Disc</b> 37.BD16290 '12-23	<b>Front Sprocket</b> 07.FS62093-12 07.FS62093-13 07.FS62093-14 07.FS62093-15 '12-23	<b>Chain</b> 07.RC520120C '12-23 MX 07.RC520120CG '12-23 MX Gold 07.RC520120XC '12-23 X-Ring 07.RC520120XCG '12-23 X-Ring Gold	<b>Swingarm</b> 26.210168 '12-16 26.210125 '17-23	<b>Seal &amp; Wiper</b> 40.S4857.89 '12-15	<b>Oil Seal Set</b> 40.F4857.89 '12-15	<b>Dust Seal Set</b> 40.F4857.8D '12-15	<b>Bushing Set</b> 39.160074 '12-15	<b>Rear Shock Seal Head Kit</b> 26.810119 '12-16 26.810120 '17-20	<b>7075-T6 Alloy Rear Sprocket</b> 07.RA62090-48 07.RA62090-49 07.RA62090-50 07.RA62090-51 07.RA62090-52 '12-23	<b>Countershaft Seal Kit</b> 26.640001 '12-23	<b>Ultraight Steel Rear Sprocket</b> 07.RS62090R-48 07.RS62090R-49 07.RS62090R-50 07.RS62090R-51 07.RS62090R-52 '12-23	<b>Sprocket Bolt Set</b> 07.SBMS825 '12-23	<b>Front Master Cylinder Rebuild Kit</b> 37.910026 '12-13 37.910035 '14-23	<b>Rear Master Cylinder Rebuild Kit</b> 37.910028 '12 37.910030 '13-23	<b>Brake Pedal Rebuild Kit</b> 37.RBPK001 '12-16 37.RBPK003 '17	
<b>Throttle Cable</b> 53.110045 '12-16 53.112060 '17-19 53.112073 '20-23	<b>Master Cylinder Rebuild Kit</b> 16.940000 '12-23	<b>Friction Set</b> 16.S53011 '12-23	<b>R/W Bearing</b> 23.S112073 '12-23	<b>Rearbrake Disc</b> 37.BD26190 '12-23			<b>Upper</b> 26.350059 '12-23													
<b>Oil Filter</b> 54.63652 '12-23 1-Pce. 54.63652-50 '12-23 50-Pcs.		<b>Steel Set</b> 16.S53029 '12-23	<b>F/W Spacer Kit</b> 26.710087 '12-15 26.710103 '16-23	<b>Front Pad Set</b> 37.102202 '12-23 37.102202BX '12-23 Box of 10			<b>Lower</b> 26.410089 '12-16 26.450077 '17-23													
<b>Water Pump Rebuild Kit</b> 57.6321 '12-16 57.6327 '17			<b>R/W Spacer Kit</b> 26.710084 '12-23	<b>Rear Pad Set</b> 37.202302 '12-23 37.202302BX '12-23 Box of 10																
			<b>Steering Bearing</b> 24.110026 '12-23	<b>Front Caliper Rebuild Kit</b> 37.63046 '12-23																
				<b>Rear Caliper Rebuild Kit</b> 37.63048 '12-16																

**DIRT**  
APRILIA  
BETA  
BMW  
GAS GAS  
HONDA  
HUSABERG  
HUSQVARNA  
KAWASAKI  
KTM  
MOTO TM  
RIEJU  
SHERCO  
SUZUKI  
YAMAHA

**STREET**  
APRILIA  
CAGIVA  
HONDA  
KAWASAKI  
KTM  
SUZUKI  
YAMAHA

**ATV-UTV**  
CAN-AM  
GAS GAS  
HONDA  
KAWASAKI  
KTM  
POLARIS  
SUZUKI  
YAMAHA

**PWC**  
KAWASAKI  
POLARIS  
SEA DOO  
YAMAHA

**SNOW**  
ARCTIC CAT  
KAWASAKI  
LYNX  
MOTO-SKI  
POLARIS  
SKI DOO  
YAMAHA

**MOPED  
&  
SCOOTER**

**MISC.  
TECH.  
SPECIAL**

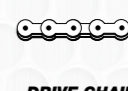

**KTM**

**DIRT**  
APRILIA  
BETA  
BMW  
GAS GAS  
HONDA  
HUSABERG  
HUSQVARNA  
KAWASAKI  
KTM  
MOTO TM  
RIEJU  
SHERCO  
SUZUKI  
YAMAHA

KTM 360 SX - EXC 2-Stroke Please Note: Nikasil Piston Size -Forged Piston	<b>Piston Kit</b> 01.6397.A 01.6397.B 01.6397.C '96-97	<b>Size</b> 77.94 77.95 77.96	<b>Ring Set</b> 02.6398 02.6398 02.6398 '96-97	<b>Oilseal Set</b> 42.6320 '96-97	<b>S/E Bearing</b> 21.6320 '96-97	<b>Complete</b> 34.6346 '96-97				
				<b>Pin</b> 04.1856.9 '96-97			<b>Top-End</b> 35.6346 '96-97			
			<b>Clips</b> 05.1812 '96-97			<b>Ignition Cover Gasket</b> 19.G96300 '96-97				

**STREET**  
APRILIA  
CAGIVA  
HONDA  
KAWASAKI  
KTM  
SUZUKI  
YAMAHA

KTM 380 SX - EXC 2-Stroke Please Note: Nikasil Piston Size -Forged Piston	<b>Piston Kit</b> 01.6398.A 01.6398.B 01.6398.C '98-02	<b>Size</b> 77.94 77.95 77.96	<b>Ring Set</b> 02.6398 02.6398 02.6398 '98-02	<b>Oilseal Set</b> 42.6320 '98-02	<b>S/E Bearing</b> 21.6320 '98-02	<b>Complete</b> 34.6346 '98-02				
				<b>Pin</b> 04.1856.9 '98-02			<b>Top-End</b> 35.6346 '98-02			
			<b>Clips</b> 05.1812 '98-02			<b>Ignition Cover Gasket</b> 19.G96300 '98-02				

**PWC**  
KAWASAKI  
POLARIS  
SEA DOO  
YAMAHA

--	--	--	--	--	--	--	--	--	--	--

**SNOW**  
ARCTIC CAT  
KAWASAKI  
LYNX  
MOTO-SKI  
POLARIS  
SKI DOO  
YAMAHA

--	--	--	--	--	--	--	--	--	--	--

**MOPED & SCOOTER**

--	--	--	--	--	--	--	--	--	--	--

**MISC. TECH. SPECIAL**

--	--	--	--	--	--	--	--	--	--	--

Footnotes: \* Bearings Only \*\* Rubbers included

<b>Air Filter</b> 52.63090 '96-97	<b>Spring Kit</b> 17.CS63011 '96-97	<b>Complete Plate Set</b> 16.CPS63096 '96-97	<b>F/W Bearing</b> 23.S110063 '96-97 SX 23.S110061 '96-97 EXC	<b>Frontbrake Disc</b> 37.BD16290 '96-97	<b>Front Sprocket</b> 07.FS62093-12 07.FS62093-13 07.FS62093-14 07.FS62093-15 '96-97	<b>Chain</b> 07.RC520120C '96-97 MX 07.RC520120CG '96-97 MX Gold 07.RC520120XC '96-97 X-Ring 07.RC520120XCG '96-97 X-Ring Gold	<b>Swingarm</b> 26.210088 '96-97			
<b>Main Jet</b> 45.100-225 '96-97 Keihin	<b>Cover Gasket</b> 19.G6320 '96-97	<b>Friction Set</b> 16.S53014 '96-97	<b>R/W Bearing</b> 23.S112073 '96-97	<b>Rearbrake Disc</b> 37.BD26190 '96-97	<b>7075-T6 Alloy Rear Sprocket</b> 07.RA62090-48 07.RA62090-49 07.RA62090-50 07.RA62090-51 07.RA62090-52 '96-97	<b>Lower Chain Roller</b> 33.0003 '96-97	<b>Linkage</b> 26.110130 '96-97			
<b>Pilot Jet</b> 46.040-085 '96-97 Keihin		<b>Steel Set</b> 16.S53015 '96-97	<b>F/W Spacer Kit</b> 26.710086 '96-97 SX 26.710085 '96-97 EXC	<b>Front Pad Set</b> 37.102202 '96-97	<b>UltraLight Steel Rear Sprocket</b> 07.RS62090R-48 07.RS62090R-49 07.RS62090R-50 07.RS62090R-51 07.RS62090R-52 '96-97	<b>Countershaft Seal Kit</b> 26.640004 '96-97	<b>Lower</b> 26.410024 '96-97			
<b>Throttle Cable</b> 53.110046 '97			<b>R/W Spacer Kit</b> 26.710084 '96-97	<b>Rear Pad Set</b> 37.204202 '96-97		<b>Upper Chain Roller</b> 33.0003 '96-97				
<b>Water Pump Rebuild Kit</b> 57.6314 '96-97			<b>Steering Bearing</b> 24.110026 '96-97	<b>Front Master Cylinder Rebuild Kit</b> 37.910025 '96-97	<b>Sprocket Bolt Set</b> 07.SBSM825 '96-97					

**DIRT**  
APRILIA  
BETA  
BMW  
GAS GAS  
HONDA  
HUSABERG  
HUSQVARNA  
KAWASAKI  
KTM  
MOTO TM  
RIEJU  
SHERCO  
SUZUKI  
YAMAHA

**STREET**  
APRILIA  
CAGIVA  
HONDA  
KAWASAKI  
KTM  
SUZUKI  
YAMAHA

<b>Air Filter</b> 52.62098 '98-02	<b>Spring Kit</b> 17.CS63011 '98-02	<b>Complete Plate Set</b> 16.CPS63096 '98-02	<b>F/W Bearing</b> 23.S110063 '98-99 SX 23.S110061 '98-99 EXC 23.S110081 '00-02 SX 23.S110080 '00-02 EXC	<b>Frontbrake Disc</b> 37.BD16290 '98-02	<b>Front Sprocket</b> 07.FS62093-12 07.FS62093-13 07.FS62093-14 07.FS62093-15 '98-02	<b>Chain</b> 07.RC520120C '98-02 MX 07.RC520120CG '98-02 MX Gold 07.RC520120XC '98-02 X-Ring 07.RC520120XCG '98-02 X-Ring Gold	<b>Swingarm</b> 26.210088 '98-02	<b>Seal &amp; Wiper</b> 40.S4352.99P '00-02		
<b>Main Jet</b> 45.100-225 '98-02 Keihin	<b>Cover Gasket</b> 19.G6320 '98-02	<b>Friction Set</b> 16.S53014 '98-02	<b>R/W Bearing</b> 23.S112073 '98-02	<b>Rearbrake Disc</b> 37.BD26190 '98-02	<b>7075-T6 Alloy Rear Sprocket</b> 07.RA62090-48 07.RA62090-49 07.RA62090-50 07.RA62090-51 07.RA62090-52 '98-02	<b>Lower Chain Roller</b> 33.0003 '98-02	<b>Upper</b> 26.350059 '02	<b>Oil Seal Set</b> 40.F4352.99P '00-02		
<b>Pilot Jet</b> 46.040-085 '98-02 Keihin	<b>Master Cylinder Rebuild Kit</b> 16.940002 '98-02 EXC '00-02 SX	<b>Steel Set</b> 16.S53015 '98-02	<b>F/W Spacer Kit</b> 26.710086 '98-99 SX 26.710089 '00-02 SX 26.710085 '98-99 EXC 26.710088 '00-02 EXC	<b>Front Pad Set</b> 37.102202 '98-02	<b>UltraLight Steel Rear Sprocket</b> 07.RS62090R-48 07.RS62090R-49 07.RS62090R-50 07.RS62090R-51 07.RS62090R-52 '98-02	<b>Countershaft Seal Kit</b> 26.640004 '98-02	<b>Dust Seal Set</b> 40.F4353.4DP '00-02	<b>Bushing Set</b> 39.160053 '00-01		
<b>Carburetor Rebuild Kit</b> 55.10517 '00-02	<b>Slave Cylinder Rebuild Kit</b> 16.950008 '00-02		<b>R/W Spacer Kit</b> 26.710084 '98-02	<b>Rear Pad Set</b> 37.204202 '98-02		<b>Upper Chain Roller</b> 33.0003 '98-02	<b>Rear Shock Seal Head Kit</b> 26.810119 '99-02			
<b>Throttle Cable</b> 53.110046 '00-02 SX '98-02 EXC			<b>Steering Bearing</b> 24.110026 '98-02	<b>Front Caliper Rebuild Kit</b> 37.63047 '98-02	<b>Sprocket Bolt Set</b> 07.SBSM825 '98-02					
<b>Water Pump Rebuild Kit</b> 57.6314 '98-02				<b>Rear Caliper Rebuild Kit</b> 37.63050 '01-02						
				<b>Front Master Cylinder Rebuild Kit</b> 37.910025 '98-99 37.910023 '00-02						
				<b>Brake Pedal Rebuild Kit</b> 37.RBPK002 '98-02						

**PWC**  
KAWASAKI  
POLARIS  
SEA DOO  
YAMAHA

**SNOW**  
ARCTIC CAT  
KAWASAKI  
LYNX  
MOTO-SKI  
POLARIS  
SKI DOO  
YAMAHA

**MOPED & SCOOTER**

**MISC. TECH. SPECIAL**





**KTM**

**DIRT**  
 APRILIA  
 BETA  
 BMW  
 GAS GAS  
 HONDA  
 HUSABERG  
 HUSQVARNA  
 KAWASAKI  
**KTM**  
 MOTO TM  
 RIEJU  
 SHERCO  
 SUZUKI  
 YAMAHA

**STREET**  
 APRILIA  
 CAGIVA  
 HONDA  
 KAWASAKI  
 KTM  
 SUZUKI  
 YAMAHA

**ATV-UTV**  
 CAN-AM  
 GAS GAS  
 HONDA  
 KAWASAKI  
 KTM  
 POLARIS  
 SUZUKI  
 YAMAHA

**PWC**  
 KAWASAKI  
 POLARIS  
 SEA DOO  
 YAMAHA

**SNOW**  
 ARCTIC CAT  
 KAWASAKI  
 LYNX  
 MOTO-SKI  
 POLARIS  
 SKI DOO  
 YAMAHA

**MOPED & SCOOTER**

**MISC. TECH. SPECIAL**

Model	Piston Kit	Size (mm)	Ring Set	Bearing	Con. Rod Kit			
KTM 400 LC4 4-Stroke -Forged Piston	-	89.00	-	23.NJ207ECS '98-01 Left 23.NJ306C3 '98-01 Right	03.6519 '98-01  <b>B/E Bearing</b> 22.405023F '94-97  <b>Crankpin</b> 06.4065 '94-97			
KTM 400 EXC 4-Stroke Please Note: Nikasil Piston Size -Std. Compression 11.1:1 -Forged Piston	<b>Piston Kit</b> 01.6439.A 01.6439.B 01.6439.C '09-11	94.94 94.95 94.96	<b>Ring Set</b> 02.6429 02.6429 02.6429 '09-11  <b>Pin</b> 04.1947.5 '09-11  <b>Clips</b> 05.1912 '09-11	<b>Crank Bearing &amp; Seal Kit</b> 23.CBS64012 '09-11  <b>Bearing</b> 23.SX07E39 '09-11 2x  <b>Oilseal Set</b> 42.6432 '09-11	<b>Ignition Cover Gasket</b> 19.G96408 '09-10  <b>Valve Shim Assortment</b> 29.VSA1000 '09-11 29.VSA1000-2 '09-11	<b>Cam Chain</b> 31.6428 '09-11  <b>Valve Shim Assortment</b> 29.VSA1000 '09-11  <b>Valve Seal</b> 35.VS026 '09-11 2x Intake 35.VS028 '09-11 2x Exhaust	<b>Valve</b> 28.6428-1 '09-11 2x Exhaust Steel 28.6428-2 '09-11 2x Intake Titanium  <b>Valve Seal</b> 35.VS026 '09-11 2x Intake 35.VS028 '09-11 2x Exhaust	

Footnotes: \* Bearings Only \*\* Rubbers included

Part Name	Part Name	Part Name	Part Name	Part Name	Part Name	Part Name	Part Name	Part Name							
<b>Air Filter</b> 52.61097 '98-01	<b>Spring Kit</b> 17.CS66044 '98-01	<b>Friction Set</b> 16.S56016 '98-01	<b>F/W Bearing</b> 23.S110061 '98-00 23.S110080 '01  <b>R/W Bearing</b> 23.S112083 '98-01  <b>Steering Bearing</b> 24.110026 '98-01	<b>Front Pad Set</b> 37.102202 '98-01 37.102202BX '98-01 Box of 10  <b>Rear Pad Set</b> 37.204202 '98-01 37.204202BX '98-01 Box of 10  <b>Front Caliper Rebuild Kit</b> 37.63047 '98-99  <b>Front Master Cylinder Rebuild Kit</b> 37.910025 '98-99 37.910023 '00-01  <b>Rear Master Cylinder Rebuild Kit</b> 37.910029 '01	<b>Front Sprocket</b> 07.FS66088-14 07.FS66088-15 07.FS66088-16 '98-01  <b>7075-T6 Alloy Rear Sprocket</b> 07.RA62090-48 07.RA62090-49 07.RA62090-50 07.RA62090-51 07.RA62090-52 '98-01  <b>Ultralight Steel Rear Sprocket</b> 07.RS62090R-48 07.RS62090R-49 07.RS62090R-50 07.RS62090R-51 07.RS62090R-52 '98-01  <b>Sprocket Bolt Set</b> 07.SBSM825 '98-01	<b>Chain</b> 07.RC520120C '98-01 MX 07.RC520120CG '98-01 MX Gold 07.RC520120XC '98-01 X-Ring 07.RC520120XCG '98-01 X-Ring Gold  <b>Brake Pedal Rebuild Kit</b> 37.RBPK002 '98-01  <b>Lower Chain Roller</b> 33.0003 '98-99  <b>Upper Chain Roller</b> 33.0003 '98-99 33.0008 '00-01	<b>Swingarm</b> 26.210087 '98-01  <b>Seal &amp; Wiper</b> 40.S4352.99P '00-01  <b>Oil Seal Set</b> 40.F4352.99P '00-01  <b>Dust Seal Set</b> 40.F4353.4DP '00-01  <b>Bushing Set</b> 39.160053 '00-01  <b>Rear Shock Seal Head Kit</b> 26.810119 '98-01	<b>Air Filter</b> 52.62007 '09 52.62010 '10-11  <b>Main Jet</b> 45.100-225 '09-11 Keihin  <b>Pilot Jet</b> 46.040-085 '09-11 Keihin  <b>Carburetor Rebuild Kit</b> 55.10520 '07-10  <b>Throttle Cable</b> 53.110045 '09-11  <b>Oil Filter</b> 54.63652 '09-11 1-Pce. 54.63652-50 '09-11 50-Pcs.  <b>Water Pump Rebuild Kit</b> 57.6429 '09-11	<b>Basket</b> 17.6427F * '09-11  <b>Clutch Rubber Set</b> 17.CRS1386-8 '09-11  <b>Spring Kit</b> 17.CS64049 '09-11	<b>Complete Plate Set</b> 16.CPS64009 '09 16.CPS64010 '10-11  <b>Friction Set</b> 16.S54017 '09-11  <b>Steel Set</b> 16.S54020 '09 16.S54021 '10-11	<b>F/W Bearing</b> 23.S114002 '09-11  <b>R/W Bearing</b> 23.S112073 '09-11  <b>F/W Spacer Kit</b> 26.710087 '09-11  <b>R/W Spacer Kit</b> 26.710084 '09-11  <b>Steering Bearing</b> 24.110026 '09-11	<b>Frontbrake Disc</b> 37.BD16290 '09-11  <b>Rearbrake Disc</b> 37.BD26190 '09-11  <b>Front Pad Set</b> 37.102202 '09-11 37.102202BX '09-11 Box of 10  <b>Rear Pad Set</b> 37.202302 '09-11 37.202302BX '09-11 Box of 10  <b>Front Caliper Rebuild Kit</b> 37.63047 '09 37.63046 '10  <b>Rear Caliper Rebuild Kit</b> 37.63048 '09-10  <b>Front Master Cylinder Rebuild Kit</b> 37.910024 '09 37.910026 '10-11  <b>Rear Master Cylinder Rebuild Kit</b> 37.910028 '09-11  <b>Brake Pedal Rebuild Kit</b> 37.RBPK001 '09-11	<b>Front Sprocket</b> 07.FS62093-12 07.FS62093-13 07.FS62093-14 07.FS62093-15 '09-11  <b>7075-T6 Alloy Rear Sprocket</b> 07.RA62090-48 07.RA62090-49 07.RA62090-50 07.RA62090-51 07.RA62090-52 '09-11  <b>Ultralight Steel Rear Sprocket</b> 07.RS62090R-48 07.RS62090R-49 07.RS62090R-50 07.RS62090R-51 07.RS62090R-52 '09-11  <b>Sprocket Bolt Set</b> 07.SBSM825 '09-11	<b>Chain</b> 07.RC520120C '09-11 MX 07.RC520120CG '09-11 MX Gold 07.RC520120XC '09-11 X-Ring 07.RC520120XCG '09-11 X-Ring Gold  <b>Countershaft Seal Kit</b> 26.640001 '09-11	<b>Swingarm</b> 26.210125 '09-11  <b>Upper</b> 26.350059 '09-11  <b>Lower</b> 26.410089 '09-11  <b>Seal &amp; Wiper</b> 40.S4857.89 '09-11  <b>Oil Seal Set</b> 40.F4857.89 '09-11  <b>Dust Seal Set</b> 40.F4857.8D '09-11  <b>Bushing Set</b> 39.160054 '09-11  <b>Rear Shock Seal Head Kit</b> 26.810119 '09-11

**DIRT**  
 APRILIA  
 BETA  
 BMW  
 GAS GAS  
 HONDA  
 HUSABERG  
 HUSQVARNA  
 KAWASAKI  
**KTM**  
 MOTO TM  
 RIEJU  
 SHERCO  
 SUZUKI  
 YAMAHA

**STREET**  
 APRILIA  
 CAGIVA  
 HONDA  
 KAWASAKI  
 KTM  
 SUZUKI  
 YAMAHA

**ATV-UTV**  
 CAN-AM  
 GAS GAS  
 HONDA  
 KAWASAKI  
 KTM  
 POLARIS  
 SUZUKI  
 YAMAHA

**PWC**  
 KAWASAKI  
 POLARIS  
 SEA DOO  
 YAMAHA

**SNOW**  
 ARCTIC CAT  
 KAWASAKI  
 LYNX  
 MOTO-SKI  
 POLARIS  
 SKI DOO  
 YAMAHA

**MOPED & SCOOTER**

**MISC. TECH. SPECIAL**

**KTM****DIRT**

KTM 450 SX Racing  
4-Stroke  
Please Note:  
Nikasil Piston Size  
-Std. Compression 12.0:1  
-Forged Piston

<b>Piston Kit</b> 01.6424.A 01.6424.B 01.6424.C & 01.6423.200 '03-06	<b>SIZES (mm)</b> 94.94 94.95 94.96	<b>Ring Set</b> 02.6424 02.6424 02.6424	<b>Crankbearing &amp; Seal Kit</b> 23.CBS64003 '03-06	<b>Con. Rod Kit</b> 03.6423 '03-06	<b>Complete</b> 34.6520 '03-06	<b>Camshaft Bearing</b> 23.6201-2RS '03-06	<b>Valve</b> 28.6423-1 '03-06 2x Exhaust Titanium 28.6423-2 '03-06 2x Intake Titanium
<b>High Compression</b> 01.6425.B '03-06	94.95	02.6424 '03-06	<b>Bearing</b> 23.NJ206ECP-1 '03-06 2x	<b>B/E Bearing</b> 22.324020F '03-06	<b>Top-End</b> 35.6520 '03-06		<b>Valve Seal</b> 35.VS026 '03-06 4x

**STREET**

Please Note:  
Nikasil Piston Size  
-High Compression 13.0:1  
-Forged Piston

			<b>Clips</b> 05.2012 '03-06				
--	--	--	-----------------------------------	--	--	--	--

**ATV-UTV**

Replating or  
Cylinder Sleeving  
Required for Oversizes

--	--	--	--	--	--	--	--

**PWC**

--	--	--	--	--	--	--	--

**SNOW**

--	--	--	--	--	--	--	--

**MOPED & SCOOTER**

--	--	--	--	--	--	--	--

**MISC. TECH. SPECIAL**

--	--	--	--	--	--	--	--

Footnotes: \* Bearings Only \*\* Rubbers included

**DIRT**

APRILIA  
BETA  
BMW  
GAS GAS  
HONDA  
HUSABERG  
HUSQVARNA  
KAWASAKI  
KTM  
MOTO TM  
RIEJU  
SHERCO  
SUZUKI  
YAMAHA

**STREET**

APRILIA  
CAGIVA  
HONDA  
KAWASAKI  
KTM  
SUZUKI  
YAMAHA

**ATV-UTV**

CAN-AM  
GAS GAS  
HONDA  
KAWASAKI  
KTM  
POLARIS  
SUZUKI  
YAMAHA

**PWC**

KAWASAKI  
POLARIS  
SEA DOO  
YAMAHA

**SNOW**

ARCTIC CAT  
KAWASAKI  
LYNX  
MOTO-SKI  
POLARIS  
SKI DOO  
YAMAHA

**MOPED & SCOOTER****MISC. TECH. SPECIAL**

<b>Air Filter</b> 52.62004 '03-06	<b>Spring Kit</b> 17.CS65041 '03-06	<b>Complete Plate Set</b> 16.CPS64004 '04-05	<b>F/W Bearing</b> 23.S114002 '03-06	<b>Frontbrake Disc</b> 37.BD16290 '03-06	<b>Front Sprocket</b> 07.FS62093-12 07.FS62093-13 07.FS62093-14 07.FS62093-15 '03-06	<b>Chain</b> 07.RC520120C '03-06 MX 07.RC520120CG '03-06 MX Gold 07.RC520120XC '03-06 X-Ring 07.RC520120XCG '03-06 X-Ring Gold	<b>Swingarm</b> 26.210087 '03 26.210125 '04-06	<b>Seal &amp; Wiper</b> 40.S4857.89 '03-06
<b>Main Jet</b> 45.100-225 '03-06 Keihin	<b>Cover Gasket</b> 19.G6520 '03-06	<b>Friction Set</b> 16.CPS64006 '06	<b>R/W Bearing</b> 23.S112073 '03-06	<b>Rearbrake Disc</b> 37.BD26190 '03-06	<b>7075-T6 Alloy Rear Sprocket</b> 07.RA62090-48 07.RA62090-49 07.RA62090-50 07.RA62090-51 07.RA62090-52 '03-06	<b>Upper</b> 26.350059 '03-06	<b>Oil Seal Set</b> 40.F4857.89 '03-06	
<b>Pilot Jet</b> 46.040-085 '03-06 Keihin	<b>Master Cylinder Rebuild Kit</b> 16.940001 '03	<b>Steel Set</b> 16.S54007 '04-06 16.S54009 '04-05 16.S54010 '06	<b>F/W Spacer Kit</b> 26.710087 '03-06	<b>Front Pad Set</b> 37.102202 '03-06 37.102202BX '03-06 Box of 10	<b>Countershaft Seal Kit</b> 26.640001 '03-06	<b>Dust Seal Set</b> 40.F4857.8D '03-06	<b>Lower</b> 26.410089 '03-06	
<b>Carburetor Rebuild Kit</b> 55.10521 '03-05 55.10520 '06	<b>Slave Cylinder Rebuild Kit</b> 16.950009 '03-06		<b>R/W Spacer Kit</b> 26.710084 '03-06	<b>Rear Pad Set</b> 37.202302 '03-06 37.202302BX '03-06 Box of 10	<b>UltraLight Steel Rear Sprocket</b> 07.RS62090R-48 07.RS62090R-49 07.RS62090R-50 07.RS62090R-51 07.RS62090R-52 '03-06	<b>Bushing Set</b> 39.160077 '03-04 39.160054 '05-06	<b>Upper Chain Roller</b> 33.0003 '03-06	
<b>Throttle Cable</b> 53.110043 '03-06			<b>Steering Bearing</b> 24.110026 '03-06	<b>Front Caliper Rebuild Kit</b> 37.63047 '03-06	<b>Sprocket Bolt Set</b> 07.SBSM825 '03-06	<b>Rear Shock Seal Head Kit</b> 26.810119 '03-06		
<b>Oil Filter #1</b> 54.63655 '03-06 1-Pce. 54.63655-50 '03-06 50-Pcs.				<b>Rear Caliper Rebuild Kit</b> 37.63048 '03-06				
<b>Oil Filter #2</b> 54.64157 '03-06 1-Pce. 54.64157-50 '03-06 50-Pcs.				<b>Front Master Cylinder Rebuild Kit</b> 37.910023 '03-04 37.910022 '05 37.910024 '06				
<b>Water Pump Rebuild Kit</b> 57.6322 '03-06				<b>Rear Master Cylinder Rebuild Kit</b> 37.910029 '03 37.910028 '04-06				
				<b>Brake Pedal Rebuild Kit</b> 37.RBPK002 '03 37.RBPK001 '04-06				





KTM

DIRT

- APRILIA
- BETA
- BMW
- GAS GAS
- HONDA
- HUSABERG
- HUSQVARNA
- KAWASAKI
- KTM
- MOTO TM
- RIEJU
- SHERCO
- SUZUKI
- YAMAHA

KTM 450 SX-F 4-Stroke Please Note: Nikasil Piston Size -Std. Compression 12.5:1	<b>Piston Kit</b> 01.6427.A 01.6427.B 01.6427.C '07-12	<b>Size</b> 96.94 96.95 96.96	<b>Ring Set</b> 02.6427 02.6427 02.6427 '07-12	<b>Crank Bearing &amp; Seal Kit</b> 23.CBS64007 '07-12 23.CBS64012 '13-15 23.CBS64016 '16-23	<b>Con. Rod Kit</b> 03.6427 '07-12 03.6433 '13-15 03.6436 '16-23	<b>Complete</b> 34.6427 '07-12 34.6413 '13 34.6414 '14-15 34.6416 '16-17	<b>Cam Chain</b> 31.6427 '07-12 31.6428 '13-15 31.6328 '16-18 31.1335 '19-22 31.6443 '23	<b>Valve</b> 28.6427-1 '07-12 2x Exhaust Titanium 28.6427-2 '07-12 2x Intake Titanium 28.6433-1 '13-18 2x Exhaust Titanium 28.6433-2 '13-18 2x Intake Titanium 28.6419-1 '19-23 2x Exhaust Titanium 28.6419-2 '19-23 2x Intake Titanium	<b>Valve Seal</b> 35.VS026 '07-23 4x
Please Note: Nikasil Piston Size -Std. Compression 12.6:1 -Forged Piston -Fuel Injection	01.6433.A 01.6433.B 01.6433.C '13-17	94.95 94.96 94.97	02.6429 02.6429 02.6429 '13-22	<b>Bearing</b> 23.NJ206ECP-2 '07-12 2x 23.SX07E39 '13-15 2x 23.NJ207ECP-1 '16-23 2x	<b>B/E Bearing</b> 22.354220F '07-12	<b>Top-End</b> 35.6427 '07-12 35.6433 '13-15 35.6414 '16-18 35.6419 '19-23	<b>Valve Shim Assortment</b> 29.VSA890 '07-23 29.VSA890-2 '07-23		
Please Note: Nikasil Piston Size -Std. Compression 12.75:1 -Forged Piston -Fuel Injection	01.6433.A 01.6433.B 01.6433.C '18-22	94.95 94.96 94.97	02.6429 02.6429 02.6429 '13-22	<b>Oilseal Set</b> 42.6427 '07-12 42.6432 '13-15		<b>Head &amp; Base</b> 36.6407 '07-12 36.6414 '14-15 36.6416 '16-23			
Please Note: Nikasil Piston Size -Std. Compression 13.1:1 -Forged Piston -Fuel Injection	01.6443.A 01.6443.B 01.6443.C '23	94.96 94.97 94.98	TBA TBA TBA '23			<b>Ignition Cover Gasket</b> 19.G96508 '07-12 19.G96433 '13-15 19.G96416 '16-22			
Please Note: Nikasil Piston Size -High Compression 13.5:1 -Forged Piston	<b>High Compression</b> 01.6428.A '07-12	<b>Size</b> 96.94	<b>Ring Set</b> 02.6427 '07-12						

STREET

- APRILIA
- CAGIVA
- HONDA
- KAWASAKI
- KTM
- SUZUKI
- YAMAHA

			<b>Clips</b> 05.1912 '07-22						
--	--	--	-----------------------------------	--	--	--	--	--	--

PWC

- KAWASAKI
- POLARIS
- SEA DOO
- YAMAHA

--	--	--	--	--	--	--	--	--	--

SNOW

- ARCTIC CAT
- KAWASAKI
- LYNX
- MOTO-SKI
- POLARIS
- SKI DOO
- YAMAHA

--	--	--	--	--	--	--	--	--	--

MOPED & SCOOTER

- 

--	--	--	--	--	--	--	--	--	--

MISC. TECH. SPECIAL

- 

--	--	--	--	--	--	--	--	--	--

Footnotes: \* Bearings Only \*\* Rubbers included

<b>Air Filter</b> 52.62007 '07-09 52.62010 '10 52.62011 '11-15 52.62016 '16-22 52.62023 '23	<b>Basket</b> 17.6427F * '07-11	<b>Complete Plate Set</b> 16.CPS64007 '07-11	<b>F/W Bearing</b> 23.S114002 '07-23	<b>Frontbrake Disc</b> 37.BD16290 '07-23	<b>Front Sprocket</b> 07.FS62093-12 07.FS62093-13 07.FS62093-14 07.FS62093-15 '07-23	<b>Chain</b> 07.RC520120C '07-23 MX 07.RC520120CG '07-23 MX Gold 07.RC520120XC '07-23 X-Ring 07.RC520120XCG '07-23 X-Ring Gold	<b>Swingarm</b> 26.210168 '07-12 26.210125 '13-23	<b>Seal &amp; Wiper</b> 40.S4857.89 '07-14
<b>Main Jet</b> 45.100-225 '07-12 Keihin	<b>Clutch Rubber Set</b> 17.CRS1386-8 '07-11	<b>Friction Set</b> 16.S54015 '07-11	<b>R/W Bearing</b> 23.S112073 '07-22	<b>Rearbrake Disc</b> 37.BD26190 '07-23	<b>7075-T6 Alloy Rear Sprocket</b> 07.RA62090-48 07.RA62090-49 07.RA62090-50 07.RA62090-51 07.RA62090-52 '07-23	<b>Countershaft Seal Kit</b> 26.640002 '07-12 26.640001 '13-23	<b>Linkage</b> 26.110180 '11-20	<b>Oil Seal Set</b> 40.F4857.89 '07-14
<b>Pilot Jet</b> 46.040-085 '07-12 Keihin	<b>Spring Kit</b> 17.CS64042 '07-11	<b>Steel Set</b> 16.S53011 '12-23	<b>F/W Spacer Kit</b> 26.710087 '07-14 26.710103 '15-23	<b>Front Pad Set</b> 37.102202 '07-23 37.102202BX '07-23 Box of 10	<b>7075-T6 Alloy Rear Sprocket</b> 07.RA62090-48 07.RA62090-49 07.RA62090-50 07.RA62090-51 07.RA62090-52 '07-23	<b>Upper Chain Seal Kit</b> 26.640002 '07-12 26.640001 '13-23	<b>Dust Seal Set</b> 40.F4857.8D '07-14	<b>Upper</b> 26.350059 '07-10 26.450068 '11-20
<b>Carburetor Rebuild Kit</b> 55.10520 '07-12	<b>Cover Gasket</b> 19.G6427 '07-12 19.G6414 '13-22	<b>Slave Cylinder Rebuild Kit</b> 16.950004 '09-11 16.950003 '13-22	<b>R/W Spacer Kit</b> 26.710084 '07-12 26.710102 '13-22	<b>Rear Pad Set</b> 37.202302 '07-23 37.202302BX '07-23 Box of 10	<b>UltraLight Steel Rear Sprocket</b> 07.RS62090R-48 07.RS62090R-49 07.RS62090R-50 07.RS62090R-51 07.RS62090R-52 '07-23	<b>Lower</b> 26.410089 '07-10 26.450066 '11-20	<b>Bushing Set</b> 39.160054 '07 39.160073 '08-11 39.160082 '12-14 39.160122 '15-16 39.160128 '17	<b>Lower</b> 26.410089 '07-10 26.450066 '11-20
<b>Throttle Cable</b> 53.110045 '07-15 53.112060 '16-18 53.112073 '19-22 53.112090 '23	<b>Master Cylinder Rebuild Kit</b> 16.940004 '07 16.940002 '08 16.940005 '09-11 16.940003 '12 16.940000 '13-22	<b>Oil Filter</b> 54.63652 '07-12 1-Pce. 54.63652-50 '07-12 50-Pcs. 54.63652 '16-23 1-Pce. 54.63652-50 '16-23 50-Pcs.	<b>Steering Bearing</b> 24.110026 '07-22	<b>Front Caliper Rebuild Kit</b> 37.63047 '07-08 37.63046 '09-23	<b>Sprocket Bolt Set</b> 07.SBSM825 '07-23	<b>Rear Shock Seal Head Kit</b> 26.810119 '07-10 26.810127 '11-20	<b>Rear Shock Seal Head Kit</b> 26.810119 '07-10 26.810127 '11-20	<b>Rear Shock Seal Head Kit</b> 26.810119 '07-10 26.810127 '11-20
<b>Water Pump Rebuild Kit</b> 57.6407 '07-12 57.6423 '13 57.6424 '14-15 57.6416 '16-17	<b>Slave Cylinder Rebuild Kit</b> 16.950004 '07-12 16.950003 '13-22			<b>Rear Caliper Rebuild Kit</b> 37.63048 '07-22				
				<b>Front Master Cylinder Rebuild Kit</b> 37.910024 '07-08 37.910026 '09-12 37.910035 '13-23				
				<b>Rear Master Cylinder Rebuild Kit</b> 37.910028 '07-11 37.910030 '12-23				
				<b>Brake Pedal Rebuild Kit</b> 37.RBPK001 '07-15 37.RBPK003 '16-17				

DIRT

- APRILIA
- BETA
- BMW
- GAS GAS
- HONDA
- HUSABERG
- HUSQVARNA
- KAWASAKI
- KTM
- MOTO TM
- RIEJU
- SHERCO
- SUZUKI
- YAMAHA

STREET

- APRILIA
- CAGIVA
- HONDA
- KAWASAKI
- KTM
- SUZUKI
- YAMAHA

ATV-UTV

- CAN-AM
- GAS GAS
- HONDA
- KAWASAKI
- KTM
- POLARIS
- SUZUKI
- YAMAHA

PWC

- KAWASAKI
- POLARIS
- SEA DOO
- YAMAHA

SNOW

- ARCTIC CAT
- KAWASAKI
- LYNX
- MOTO-SKI
- POLARIS
- SKI DOO
- YAMAHA

MOPED & SCOOTER

- 

MISC. TECH. SPECIAL

- 





### KTM

**DIRT**  
APRILIA  
BETA  
BMW  
GAS GAS  
HONDA  
HUSABERG  
HUSQVARNA  
KAWASAKI  
KTM  
MOTO TM  
RIEJU  
SHERCO  
SUZUKI  
YAMAHA

KTM 450 EXC Racing  
4-Stroke  
Please Note:  
Nikasil Piston Size  
-Std. Compression 11.0:1  
-Forged Piston

<b>Piston Kit</b> 01.6413.A 01.6413.B 01.6413.C '03-07	<b>Size</b> 88.95 88.96 88.97	<b>Ring Set</b> 02.6413 02.6413 02.6413 '03-07	<b>CrankBearing &amp; Seal Kit</b> 23.CBS64003 '03-07	<b>Con. Rod Kit</b> 03.6520 '03-07	<b>Complete</b> 34.6420 '03-07	<b>Camshaft Bearing</b> 23.6201-2RS '03-07	<b>Valve</b> 28.6520-1 '03-07 2x Exhaust Steel 28.6520-2 '03-07 2x Intake Steel
		<b>Pin</b> 04.2055.5 '03-07	<b>Bearing</b> 23.NJ206ECP-1 '03-07 2x	<b>B/E Bearing</b> 22.354322F '03-07	<b>Top-End</b> 35.6420 '03-07		<b>Valve Seal</b> 35.VS026 '03-07 4x
		<b>Clips</b> 05.2012 '03-07		<b>Crankpin</b> 06.3564.7 '03-07	<b>Head &amp; Base</b> 36.6412 '03-07		
					<b>Ignition Cover Gasket</b> 19.G96403 '03-07		

**STREET**  
APRILIA  
CAGIVA  
HONDA  
KAWASAKI  
KTM  
SUZUKI  
YAMAHA

**ATV-UTV**  
CAN-AM  
GAS GAS  
HONDA  
KAWASAKI  
KTM  
POLARIS  
SUZUKI  
YAMAHA

**PWC**  
KAWASAKI  
POLARIS  
SEA DOO  
YAMAHA

**SNOW**  
ARCTIC CAT  
KAWASAKI  
LYNX  
MOTO-SKI  
POLARIS  
SKI DOO  
YAMAHA

**MOPED & SCOOTER**

**MISC. TECH. SPECIAL**

**DIRT**  
APRILIA  
BETA  
BMW  
GAS GAS  
HONDA  
HUSABERG  
HUSQVARNA  
KAWASAKI  
KTM  
MOTO TM  
RIEJU  
SHERCO  
SUZUKI  
YAMAHA

**STREET**  
APRILIA  
CAGIVA  
HONDA  
KAWASAKI  
KTM  
SUZUKI  
YAMAHA

**ATV-UTV**  
CAN-AM  
GAS GAS  
HONDA  
KAWASAKI  
KTM  
POLARIS  
SUZUKI  
YAMAHA

**PWC**  
KAWASAKI  
POLARIS  
SEA DOO  
YAMAHA

**SNOW**  
ARCTIC CAT  
KAWASAKI  
LYNX  
MOTO-SKI  
POLARIS  
SKI DOO  
YAMAHA

**MOPED & SCOOTER**

**MISC. TECH. SPECIAL**

<b>Air Filter</b> 52.62004 '03-07	<b>Spring Kit</b> 17.CS65041 '03-07	<b>Complete Plate Set</b> 16.CPS65002 '03	<b>F/W Bearing</b> 23.S114002 '03-07	<b>Frontbrake Disc</b> 37.BD16290 '03-07	<b>Front Sprocket</b> 07.FS62093-12 07.FS62093-13 07.FS62093-14 07.FS62093-15 '03-07	<b>Chain</b> 07.RC520120C '03-07 MX 07.RC520120CG '03-07 MX Gold 07.RC520120XC '03-07 X-Ring 07.RC520120XCG '03-07 X-Ring Gold	<b>Swingarm</b> 26.210087 '03 26.210125 '04-07	<b>Seal &amp; Wiper</b> 40.S4857.89 '03-07
<b>Main Jet</b> 45.100-225 '03-07 Keihin	<b>Cover Gasket</b> 19.G6520 '03-07	<b>16.CPS64004</b> '04-05 <b>16.CPS64006</b> '06-07	<b>R/W Bearing</b> 23.S112073 '03-07	<b>Rearbrake Disc</b> 37.BD26190 '03-07		<b>7075-T6 Alloy Rear Sprocket</b> 07.RA62090-48 07.RA62090-49 07.RA62090-50 07.RA62090-51 07.RA62090-52 '03-07	<b>Upper</b> 26.350059 '03-07	<b>Oil Seal Set</b> 40.F4857.89 '03-07
<b>Pilot Jet</b> 46.040-085 '03-07 Keihin	<b>Master Cylinder Rebuild Kit</b> 16.940001 '03	<b>Friction Set</b> 16.S54008 '03	<b>F/W Spacer Kit</b> 26.710087 '03-07	<b>Front Pad Set</b> 37.102202 '03-07 37.102202BX '03-07 Box of 10		<b>Countershaft Seal Kit</b> 26.640001 '03-07	<b>Lower</b> 26.410089 '03-07	<b>Dust Seal Set</b> 40.F4857.8D '03-07
<b>Throttle Cable</b> 53.110043 '03-07	<b>16.940004</b> '04 <b>16.940000</b> '07	<b>16.S54007</b> '04-07	<b>R/W Spacer Kit</b> 26.710084 '03-07	<b>Rear Pad Set</b> 37.204202 '03 37.204202BX '03 Box of 10 37.202302 '04-07 37.202302BX '04-07 Box of 10		<b>UltraLight Steel Rear Sprocket</b> 07.RS62090R-48 07.RS62090R-49 07.RS62090R-50 07.RS62090R-51 07.RS62090R-52 '03-07	<b>Rear Shock Seal Head Kit</b> 26.810119 '03-07	<b>Bushing Set</b> 39.160077 '03-04 39.160054 '05-07
<b>Carburetor Rebuild Kit</b> 55.10521 '03-05 55.10520 '06-07	<b>Slave Cylinder Rebuild Kit</b> 16.950009 '03-07	<b>16.S54009</b> '04-05 <b>16.S54010</b> '06-07	<b>Steering Bearing</b> 24.110026 '03-07	<b>Front Caliper Rebuild Kit</b> 37.63047 '03-07		<b>Sprocket Bolt Set</b> 07.SBSM825 '03-07		
<b>Oil Filter #1</b> 54.63655 '03-07 1-Pce. 54.63655-50 '03-07 50-Pcs.				<b>Rear Caliper Rebuild Kit</b> 37.63048 '03-07				
<b>Oil Filter #2</b> 54.64157 '03-07 1-Pce. 54.64157-50 '03-07 50-Pcs.				<b>Front Master Cylinder Rebuild Kit</b> 37.910023 '03-04 37.910022 '05 37.910024 '06-07				
<b>Water Pump Rebuild Kit</b> 57.6322 '03-07				<b>Rear Master Cylinder Rebuild Kit</b> 37.910028 '03-06 37.910029 '07				
				<b>Brake Pedal Rebuild Kit</b> 37.RBPK002 '03 37.RBPK001 '04-07				

Footnotes: \* Bearings Only \*\* Rubbers included



**KTM**

**DIRT**

- APRILIA
- BETA
- BMW
- GAS GAS
- HONDA
- HUSABERG
- HUSQVARNA
- KAWASAKI
- KTM**
- MOTO TM
- RIEJU
- SHERCO
- SUZUKI
- YAMAHA

KTM 450 EXC-R  
4-Stroke  
Please Note:  
Nikasil Piston Size  
-Std. Compression 11.9:1  
-Forged Piston

<b>Piston Kit</b> 01.6429.A 01.6429.B 01.6429.C '08-11	<b>Size</b> 94.94 94.95 94.96	<b>Ring Set</b> 02.6429 02.6429 02.6429 '08-11	<b>CrankBearing &amp; Seal Kit</b> 23.CBS64012 '09-11	<b>Con. Rod Kit</b> 03.6428 '08-11	<b>Complete</b> 34.6438 '08-11	<b>Cam Chain</b> 31.6428 '08-11	<b>Valve</b> 28.6428-1 '08-11 2x Exhaust Steel 28.6428-2 '08-11 2x Intake Titanium
		<b>Pin</b> 04.1947.5 '08-11	<b>Bearing</b> 23.SX07E39 '08-11 2x	<b>B/E Bearing</b> 22.354220F '08-11	<b>Top-End</b> 35.6438 '08-11	<b>Valve Shim Assortment</b> 29.VSA1000 '08-11	<b>Valve Seal</b> 35.VS026 '08-11 2x Intake 35.VS028 '08-11 2x Exhaust
		<b>Clips</b> 05.1912 '08-11	<b>Oilseal Set</b> 42.6432 '09-11	<b>Crankpin</b> 06.3562.7 '08-11	<b>Ignition Cover Gasket</b> 19.G96408 '08-11		

**STREET**

- APRILIA
- CAGIVA
- HONDA
- KAWASAKI
- KTM
- SUZUKI
- YAMAHA

**ATV-UTV**

- CAN-AM
- GAS GAS
- HONDA
- KAWASAKI
- KTM
- POLARIS
- SUZUKI
- YAMAHA

**PWC**

- KAWASAKI
- POLARIS
- SEA DOO
- YAMAHA

**SNOW**

- ARCTIC CAT
- KAWASAKI
- LYNX
- MOTO-SKI
- POLARIS
- SKI DOO
- YAMAHA

**MOPED & SCOOTER**

**MISC. TECH. SPECIAL**

**DIRT**

- APRILIA
- BETA
- BMW
- GAS GAS
- HONDA
- HUSABERG
- HUSQVARNA
- KAWASAKI
- KTM**
- MOTO TM
- RIEJU
- SHERCO
- SUZUKI
- YAMAHA

**STREET**

- APRILIA
- CAGIVA
- HONDA
- KAWASAKI
- KTM
- SUZUKI
- YAMAHA

**ATV-UTV**

- CAN-AM
- GAS GAS
- HONDA
- KAWASAKI
- KTM
- POLARIS
- SUZUKI
- YAMAHA

**PWC**

- KAWASAKI
- POLARIS
- SEA DOO
- YAMAHA

**SNOW**

- ARCTIC CAT
- KAWASAKI
- LYNX
- MOTO-SKI
- POLARIS
- SKI DOO
- YAMAHA

**MOPED & SCOOTER**

**MISC. TECH. SPECIAL**

<b>Air Filter</b> 52.62007 '08-09 52.62010 '10-11	<b>Basket</b> 17.6427F * '08-11	<b>Complete Plate Set</b> 16.CPS65008 '08	<b>F/W Bearing</b> 23.S114002 '08-11	<b>Frontbrake Disc</b> 37.BD16290 '08-11	<b>Front Sprocket</b> 07.FS62093-12 07.FS62093-13 07.FS62093-14 07.FS62093-15 '08-11	<b>Chain</b> 07.RC520120C '08-11 MX 07.RC520120CG '08-11 MX Gold 07.RC520120XC '08-11 X-Ring 07.RC520120XCG '08-11 X-Ring Gold	<b>Swingarm</b> 26.210125 '08-11	<b>Seal &amp; Wiper</b> 40.S4857.89 '08-11
<b>Main Jet</b> 45.100-225 '08-11 Keihin	<b>Clutch Rubber Set</b> 17.CRS1386-8 '08-11	<b>Friction Set</b> 16.CPS64010 '10-11	<b>R/W Bearing</b> 23.S112073 '08-11	<b>Rearbrake Disc</b> 37.BD26190 '08-11	<b>7075-T6 Alloy Rear Sprocket</b> 07.RA62090-48 07.RA62090-49 07.RA62090-50 07.RA62090-51 07.RA62090-52 '08-11	<b>Upper</b> 26.350059 '08-11	<b>Oil Seal Set</b> 40.F4857.89 '08-11	
<b>Pilot Jet</b> 46.040-085 '08-11 Keihin	<b>Spring Kit</b> 17.CS64049 '08-11	<b>Steel Set</b> 16.S54016 '08 16.S54017 '09-11	<b>F/W Spacer Kit</b> 26.710087 '08-11	<b>Front Pad Set</b> 37.102202 '08-11	<b>Countershaft Seal Kit</b> 26.640001 '08-11	<b>Lower</b> 26.410089 '08-11	<b>Dust Seal Set</b> 40.F4857.8D '08-11	
<b>Throttle Cable</b> 53.110045 '08-11	<b>Master Cylinder Rebuild Kit</b> 16.940000 '08-11	<b>Slave Cylinder Rebuild Kit</b> 16.950005 '08-11	<b>R/W Spacer Kit</b> 26.710084 '08-11	<b>Front Pad Set</b> 37.102202BX '08-11 Box of 10	<b>Ultralight Steel Rear Sprocket</b> 07.RS62090R-48 07.RS62090R-49 07.RS62090R-50 07.RS62090R-51 07.RS62090R-52 '08-11	<b>Bushing Set</b> 39.160074 '08 39.160054 '09-11	<b>Rear Shock Seal Head Kit</b> 26.810119 '08-11	
<b>Carburetor Rebuild Kit</b> 55.10520 '08-11	<b>Oil Filter</b> 54.63652 '08-11 1-Pce. 54.63652-50 '08-11 50-Pcs.	<b>Water Pump Rebuild Kit</b> 57.6429 '08-11	<b>Steering Bearing</b> 24.110026 '08-11	<b>Rear Pad Set</b> 37.202302 '08-11	<b>Sprocket Bolt Set</b> 07.SBSM825 '08-11			
				<b>Rear Caliper Rebuild Kit</b> 37.63047 '03-09 37.63046 '10-11				
				<b>Front Master Cylinder Rebuild Kit</b> 37.910024 '08-09 37.910026 '10-11				
				<b>Rear Master Cylinder Rebuild Kit</b> 37.910028 '08-11				
				<b>Brake Pedal Rebuild Kit</b> 37.RBPK001 '08-11				

Footnotes: \* Bearings Only \*\* Rubbers included



**KTM****DIRT**  
APRILIA  
BETA  
BMW  
GAS GAS  
HONDA  
HUSABERG  
HUSQVARNA  
KAWASAKI  
KTM  
MOTO TM  
RIEJU  
SHERCO  
SUZUKI  
YAMAHA

KTM 450 EXC 4-Stroke Please Note: Nikasil Piston Size -Std. Compression 11.8:1 -Forged Piston -Fuel Injection	<b>Piston Kit</b> 01.6432.A 01.6432.B 01.6432.C '12-16	<b>Size</b> 94.94 94.95 94.96	<b>Ring Set</b> 02.6429 02.6429 02.6429 '12-16	<b>Crank Bearing &amp; Seal Kit</b> 23.CBS64012 '12-16	<b>Con. Rod Kit</b> 03.6432 '12-13 03.6433 '14-16	<b>Complete</b> 34.6512 '12-13 34.6413 '14-16	<b>Cam Chain</b> 31.6428 '12-16	<b>Valve</b> 28.6428-1 '12-16 2x Exhaust Steel 28.6428-2 '12-13 2x Intake Titanium 28.6433-2 '14-16 2x Intake Titanium
			<b>Pin</b> 04.1947.5 '12-16	<b>Bearing</b> 23.SX07E39 '12-16 2x	<b>Top-End</b> 35.6438 '12-16	<b>Head &amp; Base</b> 36.6414 '14-16	<b>Valve Shim Assortment</b> 29.VSA1000 '12-13 29.VSA1000-2 '12-13	<b>Valve Seal</b> 35.VS026 '12-16 2x Intake 35.VS028 '12-16 2x Exhaust
			<b>Clips</b> 05.1912 '12-16	<b>Oilseal Set</b> 42.6432 '12-16	<b>B/E Bearing</b> 22.354220F '12-13	<b>Ignition Cover Gasket</b> 19.G96433 '12-16		
					<b>Crankpin</b> 06.3562.7 '12-13			

**STREET**  
APRILIA  
CAGIVA  
HONDA  
KAWASAKI  
KTM  
SUZUKI  
YAMAHA**ATV-UTV**  
CAN-AM  
GAS GAS  
HONDA  
KAWASAKI  
KTM  
POLARIS  
SUZUKI  
YAMAHA**PWC**  
KAWASAKI  
POLARIS  
SEA DOO  
YAMAHA**SNOW**  
ARCTIC CAT  
KAWASAKI  
LYNX  
MOTO-SKI  
POLARIS  
SKI DOO  
YAMAHA**MOPED & SCOOTER****MISC. TECH. SPECIAL**

KTM 450 EXC-F 4-Stroke Please Note: Nikasil Piston Size -Std. Compression 11.8:1 -Forged Piston -Fuel Injection	<b>Piston Kit</b> 01.6432.A 01.6432.B 01.6432.C '17-19	<b>Size</b> 94.94 94.95 94.96	<b>Ring Set</b> 02.6429 02.6429 02.6429 '17-19	<b>Crank Bearing &amp; Seal Kit</b> 23.CBS64016 '17-23	<b>Con. Rod Kit</b> 03.6436 '17-23	<b>Top-End</b> 35.6417 '17-18 35.6439 '19-23	<b>Cam Chain</b> 31.6328 '17-19 31.1335 '20-23	<b>Valve</b> 28.6428-1 '17-19 2x Exhaust Steel 28.6433-2 '17-19 2x Intake Titanium 28.6420-1 '20-23 2x Exhaust Steel 28.6419-2 '20-23 2x Intake Titanium
				<b>Bearing</b> 23.NJ207ECP-1 '17-23 2x	<b>Crankpin</b> 06.3562 '17-23	<b>Head &amp; Base</b> 36.6416 '17-23	<b>Valve Shim Assortment</b> 29.VSA890 '17-23 29.VSA890-2 '17-23	<b>Valve Seal</b> 35.VS026 '17-23 2x Intake 35.VS028 '17-23 2x Exhaust
			<b>Pin</b> 04.1947.5 '17-20			<b>Ignition Cover Gasket</b> 19.G96416 '17-23		
			<b>Clips</b> 05.1912 '17-20					

Footnotes: \* Bearings Only \*\* Rubbers included

**DIRT**  
APRILIA  
BETA  
BMW  
GAS GAS  
HONDA  
HUSABERG  
HUSQVARNA  
KAWASAKI  
KTM  
MOTO TM  
RIEJU  
SHERCO  
SUZUKI  
YAMAHA**STREET**  
APRILIA  
CAGIVA  
HONDA  
KAWASAKI  
KTM  
SUZUKI  
YAMAHA**ATV-UTV**  
CAN-AM  
GAS GAS  
HONDA  
KAWASAKI  
KTM  
POLARIS  
SUZUKI  
YAMAHA**PWC**  
KAWASAKI  
POLARIS  
SEA DOO  
YAMAHA**SNOW**  
ARCTIC CAT  
KAWASAKI  
LYNX  
MOTO-SKI  
POLARIS  
SKI DOO  
YAMAHA**MOPED & SCOOTER****MISC. TECH. SPECIAL**

<b>Air Filter</b> 52.62011 '12-16	<b>Cover</b> 19.G6414 '12-16	<b>Complete Plate Set</b> 16.CPS64012 '12-16	<b>F/W Bearing</b> 23.S114002 '12-16	<b>Frontbrake Disc</b> 37.BD16290 '12-16	<b>Front Sprocket</b> 07.FS62093-12 07.FS62093-13 07.FS62093-14 07.FS62093-15 '12-16	<b>Chain</b> 07.RC520120C '12-16 MX 07.RC520120CG '12-16 MX Gold 07.RC520120XC '12-16 X-Ring 07.RC520120XCG '12-16 X-Ring Gold	<b>Swingarm</b> 26.210125 '12-16	<b>Seal &amp; Wiper</b> 40.S4857.89 '12-15
<b>Throttle Cable</b> 53.110045 '12-16	<b>Cover Gasket</b> 19.G6414 '12-16	<b>Friction Set</b> 16.S53011 '12-16	<b>R/W Bearing</b> 23.S112073 '12-16	<b>Rearbrake Disc</b> 37.BD26190 '12-16		<b>Upper</b> 26.350059 '12-16	<b>Oil Seal Set</b> 40.F4857.89 '12-15	
<b>Oil Filter</b> 54.63655 '12-16 1-Pce. 54.63655-50 '12-16 50-Pcs.	<b>Master Cylinder Rebuild Kit</b> 16.940000 '12-14	<b>Steel Set</b> 16.S53029 '12-16	<b>F/W Spacer Kit</b> 26.710087 '12-15 26.710103 '16	<b>Front Pad Set</b> 37.102202 '12-16	<b>7075-T6 Alloy Rear Sprocket</b> 07.RA62090-48 07.RA62090-50 07.RA62090-51 07.RA62090-52 '12-16	<b>Lower</b> 26.410089 '12-16	<b>Dust Seal Set</b> 40.F4857.8D '12-15	
<b>Water Pump Rebuild Kit</b> 57.6522 '12-13 57.6423 '14-16	<b>Slave Cylinder Rebuild Kit</b> 16.950005 '12-14		<b>R/W Spacer Kit</b> 26.710084 '12-16	<b>Rear Pad Set</b> 37.202302 '12-16	<b>Countershaft Seal Kit</b> 26.640001 '12-16	<b>UltraLight Steel Rear Sprocket</b> 07.RS62090R-48 07.RS62090R-49 07.RS62090R-50 07.RS62090R-51 07.RS62090R-52 '12-16	<b>Bushing Set</b> 39.160074 '12-15	
			<b>Steering Bearing</b> 24.110026 '12-16	<b>Rear Caliper Rebuild Kit</b> 37.63046 '12-16	<b>Sprocket Bolt Set</b> 07.SBSM825 '12-16	<b>Rear Shock Seal Head Kit</b> 26.810119 '12-16		
				<b>Front Caliper Rebuild Kit</b> 37.63046 '12-16				
				<b>Rear Caliper Rebuild Kit</b> 37.63048 '12-16				
				<b>Front Master Cylinder Rebuild Kit</b> 37.910026 '12-13 37.910035 '14-16				
				<b>Rear Master Cylinder Rebuild Kit</b> 37.910028 '12 37.910030 '13-16				
				<b>Brake Pedal Rebuild Kit</b> 37.RBPK001 '12-16				

<b>Air Filter</b> 52.62016 '17-23	<b>Cover Gasket</b> 19.G6414 '17-23	<b>Complete Plate Set</b> 16.CPS64012 '17-23	<b>F/W Bearing</b> 23.S114002 '17-23	<b>Frontbrake Disc</b> 37.BD16290 '17-23	<b>Front Sprocket</b> 07.FS62093-12 07.FS62093-13 07.FS62093-14 07.FS62093-15 '17-23	<b>Chain</b> 07.RC520120C '17-23 MX 07.RC520120CG '17-23 MX Gold 07.RC520120XC '17-23 X-Ring 07.RC520120XCG '17-23 X-Ring Gold	<b>Swingarm</b> 26.210125 '17-23	<b>Rear Shock Seal Head Kit</b> 26.810120 '17-20
<b>Throttle Cable</b> 53.112060 '17-19 53.112073 '20-23	<b>Master Cylinder Rebuild Kit</b> 16.940000 '17-20	<b>Friction Set</b> 16.S53011 '17-23	<b>R/W Bearing</b> 23.S112073 '17-23	<b>Rearbrake Disc</b> 37.BD26190 '17-23		<b>Upper</b> 26.350059 '17-23		
<b>Oil Filter</b> 54.63652 '17-23 1-Pce. 54.63652-50 '17-23 50-Pcs.	<b>Slave Cylinder Rebuild Kit</b> 16.950003 '17-20	<b>Steel Set</b> 16.S53029 '17-23	<b>F/W Spacer Kit</b> 26.710103 '17-23	<b>Front Pad Set</b> 37.102202 '17-23 37.102202BX '17-23 Box of 10	<b>7075-T6 Alloy Rear Sprocket</b> 07.RA62090-48 07.RA62090-49 07.RA62090-50 07.RA62090-51 07.RA62090-52 '17-23	<b>Lower</b> 26.450077 '17-23		
			<b>R/W Spacer Kit</b> 26.710084 '17-23	<b>Rear Pad Set</b> 37.202302 '17-23	<b>Countershaft Seal Kit</b> 26.640001 '17-23	<b>UltraLight Steel Rear Sprocket</b> 07.RS62090R-48 07.RS62090R-49 07.RS62090R-50 07.RS62090R-51 07.RS62090R-52 '17-23		
			<b>Steering Bearing</b> 24.110026 '17-23	<b>Rear Caliper Rebuild Kit</b> 37.63046 '17-23	<b>Sprocket Bolt Set</b> 07.SBSM825 '17-23			
				<b>Front Caliper Rebuild Kit</b> 37.63046 '17-23				
				<b>Front Master Cylinder Rebuild Kit</b> 37.910035 '17-23				
				<b>Rear Master Cylinder Rebuild Kit</b> 37.910030 '17-23				





PISTON KITS



SIZES (mm)



PISTON PARTS



CRANKSHAFT PARTS



CONNECTING ROD PARTS



GASKETS



VALVE TRAIN PARTS I



VALVE TRAIN PARTS II



AIR & FUEL PARTS



CLUTCH PARTS



CLUTCH PLATE SETS



WHEEL & STEERING PARTS



BRAKE PARTS



DRIVE CHAIN PARTS I



DRIVE CHAIN PARTS II



SUSPENSION BEARING KITS



SUSPENSION PARTS



KTM

DIRT

APRILIA BETA BMW GAS GAS HONDA HUSABERG HUSQVARNA KAWASAKI KTM MOTO TM RIEJU SHERCO SUZUKI YAMAHA

Table with 10 columns: Model, Piston Kit, Size, Ring Set, Crank Bearing & Seal Kit, Con. Rod Kit, Complete, Cam Chain, Valve, Air Filter, Spring Kit, Complete Plate Set, F/W Bearing, Rearbrake Disc, Front Sprocket, Chain, Swingarm, Seal & Wiper. Rows include KTM 450 SM-R and KTM 450 SMR.

STREET

APRILIA CAGIVA HONDA KAWASAKI KTM SUZUKI YAMAHA

Table with 10 columns: Model, Piston Kit, Size, Ring Set, Crank Bearing & Seal Kit, Con. Rod Kit, Complete, Cam Chain, Valve, Air Filter, Spring Kit, Complete Plate Set, F/W Bearing, Rearbrake Disc, Front Sprocket, Chain, Swingarm, Seal & Wiper. Rows include KTM 450 SM-R and KTM 450 SMR.

ATV-UTV

CAN-AM GAS GAS HONDA KAWASAKI KTM POLARIS SUZUKI YAMAHA

Table with 10 columns: Model, Piston Kit, Size, Ring Set, Crank Bearing & Seal Kit, Con. Rod Kit, Complete, Cam Chain, Valve, Air Filter, Spring Kit, Complete Plate Set, F/W Bearing, Rearbrake Disc, Front Sprocket, Chain, Swingarm, Seal & Wiper. Rows include KTM 450 SMR and KTM 450 SMR.

PWC

KAWASAKI POLARIS SEA DOO YAMAHA

Table with 10 columns: Model, Piston Kit, Size, Ring Set, Crank Bearing & Seal Kit, Con. Rod Kit, Complete, Cam Chain, Valve, Air Filter, Spring Kit, Complete Plate Set, F/W Bearing, Rearbrake Disc, Front Sprocket, Chain, Swingarm, Seal & Wiper. Rows include KTM 450 SMR and KTM 450 SMR.

SNOW

ARCTIC CAT KAWASAKI LYNX MOTO-SKI POLARIS SKI DOO YAMAHA

Table with 10 columns: Model, Piston Kit, Size, Ring Set, Crank Bearing & Seal Kit, Con. Rod Kit, Complete, Cam Chain, Valve, Air Filter, Spring Kit, Complete Plate Set, F/W Bearing, Rearbrake Disc, Front Sprocket, Chain, Swingarm, Seal & Wiper. Rows include KTM 450 SMR and KTM 450 SMR.

MOPED & SCOOTER

ARCTIC CAT KAWASAKI LYNX MOTO-SKI POLARIS SKI DOO YAMAHA

Table with 10 columns: Model, Piston Kit, Size, Ring Set, Crank Bearing & Seal Kit, Con. Rod Kit, Complete, Cam Chain, Valve, Air Filter, Spring Kit, Complete Plate Set, F/W Bearing, Rearbrake Disc, Front Sprocket, Chain, Swingarm, Seal & Wiper. Rows include KTM 450 SMR and KTM 450 SMR.

MISC. TECH. SPECIAL

ARCTIC CAT KAWASAKI LYNX MOTO-SKI POLARIS SKI DOO YAMAHA

Table with 10 columns: Model, Piston Kit, Size, Ring Set, Crank Bearing & Seal Kit, Con. Rod Kit, Complete, Cam Chain, Valve, Air Filter, Spring Kit, Complete Plate Set, F/W Bearing, Rearbrake Disc, Front Sprocket, Chain, Swingarm, Seal & Wiper. Rows include KTM 450 SMR and KTM 450 SMR.

Footnotes: \* Bearings Only \*\* Rubbers included

DIRT

APRILIA BETA BMW GAS GAS HONDA HUSABERG HUSQVARNA KAWASAKI KTM MOTO TM RIEJU SHERCO SUZUKI YAMAHA

STREET

APRILIA CAGIVA HONDA KAWASAKI KTM SUZUKI YAMAHA

ATV-UTV

CAN-AM GAS GAS HONDA KAWASAKI KTM POLARIS SUZUKI YAMAHA

PWC

KAWASAKI POLARIS SEA DOO YAMAHA

SNOW

ARCTIC CAT KAWASAKI LYNX MOTO-SKI POLARIS SKI DOO YAMAHA

MOPED & SCOOTER

ARCTIC CAT KAWASAKI LYNX MOTO-SKI POLARIS SKI DOO YAMAHA

MISC. TECH. SPECIAL

ARCTIC CAT KAWASAKI LYNX MOTO-SKI POLARIS SKI DOO YAMAHA

**KTM**

**DIRT**  
APRILIA  
BETA  
BMW  
GAS GAS  
HONDA  
HUSABERG  
HUSQVARNA  
KAWASAKI  
KTM  
MOTO TM  
RIEJU  
SHERCO  
SUZUKI  
YAMAHA

KTM 500 EXC 4-Stroke Please Note: Nikasil Piston Size -Std. Compression 11.8:1 -Forged Piston -Fuel Injection	<b>Piston Kit</b> 01.6512.A 01.6512.B 01.6512.C '12-16	<b>Size</b> 94.95 94.96 94.97	<b>Ring Set</b> 02.6429 02.6429 02.6429 '12-16	<b>CrankBearing &amp; Seal Kit</b> 23.CBS64012 '12-16  <b>Bearing</b> 23.SX07E39 '12-16 2x  <b>Oilseal Set</b> 42.6432 '12-16	<b>Con. Rod Kit</b> 03.6512 '12-13  <b>B/E Bearing</b> 22.354220F '12-13  <b>Crankpin</b> 06.3562.7 '12-13	<b>Complete</b> 34.6512 '12-16  <b>Top-End</b> 35.6438 '12-16  <b>Head &amp; Base</b> 36.6414 '14-16  <b>Ignition Cover Gasket</b> 19.G96433 '12-16	<b>Cam Chain</b> 31.6508 '12-16  <b>Valve Shim Assortment</b> 29.VSA1000 '12-13 29.VSA1000-2 '12-13 29.VSA890 '14-16 29.VSA890-2 '14-16	<b>Valve</b> 28.6428-1 '12-16 2x Exhaust Steel 28.6428-2 '12-13 2x Intake Titanium 28.6433-2 '14-16 2x Intake Titanium  <b>Valve Seal</b> 35.VS026 '12-16 2x Intake 35.VS028 '12-16 2x Exhaust
---	--	--	--	---	--	---	---	---

**STREET**  
APRILIA  
CAGIVA  
HONDA  
KAWASAKI  
KTM  
SUZUKI  
YAMAHA

--	--	--	--	--	--	--	--	--

**ATV-UTV**  
CAN-AM  
GAS GAS  
HONDA  
KAWASAKI  
KTM  
POLARIS  
SUZUKI  
YAMAHA

--	--	--	--	--	--	--	--	--

**PWC**  
KAWASAKI  
POLARIS  
SEA DOO  
YAMAHA

KTM 500 EXC-F 4-Stroke Please Note: Nikasil Piston Size -Std. Compression 11.8:1 -Forged Piston -Fuel Injection	<b>Piston Kit</b> 01.6512.A 01.6512.B 01.6512.C '17-19	<b>Size</b> 94.95 94.96 94.97	<b>Ring Set</b> 02.6429 02.6429 02.6429 '17-23	<b>CrankBearing &amp; Seal Kit</b> 23.CBS64016 '17-23  <b>Bearing</b> 23.NJ207ECP-1 '17-23 2x	<b>Top-End</b> 35.6417 '17-18 35.6439 '19-23  <b>Head &amp; Base</b> 36.6416 '17-23  <b>Ignition Cover Gasket</b> 19.G96416 '17-23	<b>Cam Chain</b> 31.1403 '17-19 31.6328 '20-23  <b>Valve Shim Assortment</b> 29.VSA890 '17-23 29.VSA890-2 '17-23	<b>Valve</b> 28.6428-1 '17-19 2x Exhaust Steel 28.6433-2 '17-19 2x Intake Titanium 28.6420-1 '20-23 2x Exhaust Steel 28.6419-2 '20-23 2x Intake Titanium  <b>Valve Seal</b> 35.VS026 '17-23 2x Intake 35.VS028 '17-23 2x Exhaust
---	--	--	--	---	--	--	--

**SNOW**  
ARCTIC CAT  
KAWASAKI  
LYNX  
MOTO-SKI  
POLARIS  
SKI DOO  
YAMAHA

Please Note: Nikasil Piston Size -Std. Compression 12.75:1 -Forged Piston -Fuel Injection	01.6513.A 01.6513.B 01.6513.C '20-23	94.95 94.96 94.97	02.6429 02.6429 02.6429 '17-23					
---	---	-------------------------	---	--	--	--	--	--

**MOPED & SCOOTER**

--	--	--	--	--	--	--	--	--

**MISC. TECH. SPECIAL**

--	--	--	--	--	--	--	--	--

Footnotes: \* Bearings Only \*\* Rubbers included

<b>Air Filter</b> 52.62011 '12-16  <b>Throttle Cable</b> 53.110045 '12-16  <b>Oil Filter</b> 54.63655 '12-16 1-Pce. 54.63655-50 '12-16 50-Pcs.  <b>Water Pump Rebuild Kit</b> 57.6522 '12-15 57.6423 '16	<b>Cover</b> 19.G6432 '12-16  <b>Cover Gasket</b> 19.G6414 '12-16  <b>Master Cylinder Rebuild Kit</b> 16.940000 '12-16  <b>Slave Cylinder Rebuild Kit</b> 16.950005 '12-16	<b>Complete Plate Set</b> 16.CPS64012 '12-16  <b>Friction Set</b> 16.S53011 '12-16  <b>Steel Set</b> 16.S53019 '12-16	<b>F/W Bearing</b> 23.S114002 '12-16  <b>R/W Bearing</b> 23.S112073 '12-16  <b>F/W Spacer Kit</b> 26.710087 '12-15 26.710103 '16  <b>R/W Spacer Kit</b> 26.710084 '12-16  <b>Steering Bearing</b> 24.110026 '12-16	<b>Frontbrake Disc</b> 37.BD16290 '12-16  <b>Rearbrake Disc</b> 37.BD26190 '12-16  <b>Front Pad Set</b> 37.102202 '12-16 37.102202BX '12-16 Box of 10  <b>Rear Pad Set</b> 37.202302 '12-16 37.202302BX '12-16 Box of 10  <b>Front Caliper Rebuild Kit</b> 37.63046 '12-16  <b>Rear Caliper Rebuild Kit</b> 37.63048 '12-16  <b>Front Master Cylinder Rebuild Kit</b> 37.910026 '12 37.910035 '13-16  <b>Rear Master Cylinder Rebuild Kit</b> 37.910028 '12 37.910030 '13-16  <b>Brake Pedal Rebuild Kit</b> 37.RBPK001 '12-16	<b>Front Sprocket</b> 07.FS62093-12 07.FS62093-13 07.FS62093-14 07.FS62093-15 '12-16  <b>7075-T6 Alloy Rear Sprocket</b> 07.RA62090-48 07.RA62090-49 07.RA62090-50 07.RA62090-51 07.RA62090-52 '12-16  <b>Ultralight Steel Rear Sprocket</b> 07.RS62090R-48 07.RS62090R-49 07.RS62090R-50 07.RS62090R-51 07.RS62090R-52 '12-16  <b>Sprocket Bolt Set</b> 07.SBSM825 '12-16	<b>Chain</b> 07.RC520120C '12-16 MX 07.RC520120CG '12-16 MX Gold 07.RC520120XC '12-16 X-Ring 07.RC520120XCG '12-16 X-Ring Gold  <b>Countershaft Seal Kit</b> 26.640001 '12-16	<b>Swingarm</b> 26.210125 '12-16  <b>Upper</b> 26.350059 '12-16  <b>Lower</b> 26.410089 '12-16	<b>Seal &amp; Wiper</b> 40.S4857.89 '12-15  <b>Oil Seal Set</b> 40.F4857.89 '12-15  <b>Dust Seal Set</b> 40.F4857.8D '12-15  <b>Bushing Set</b> 39.160074 '12-15  <b>Rear Shock Seal Head Kit</b> 26.810119 '12-16
--	--	---	--	--	---	---	--	--

--	--	--	--	--	--	--	--	--

--	--	--	--	--	--	--	--	--

<b>Air Filter</b> 52.62016 '17-23  <b>Throttle Cable</b> 53.112061 '17-19 53.112073 '20-23  <b>Oil Filter</b> 54.63652 '17-23 1-Pce. 54.63652-50 '17-23 50-Pcs.	<b>Cover Gasket</b> 19.G6414 '17-23  <b>Master Cylinder Rebuild Kit</b> 16.940000 '17-23  <b>Slave Cylinder Rebuild Kit</b> 16.950003 '17-23	<b>Complete Plate Set</b> 16.CPS64012 '17-23  <b>Friction Set</b> 16.S53011 '17-23  <b>Steel Set</b> 16.S53029 '17-23	<b>F/W Bearing</b> 23.S114002 '17-23  <b>R/W Bearing</b> 23.S112073 '17-23  <b>F/W Spacer Kit</b> 26.710103 '17-23  <b>R/W Spacer Kit</b> 26.710084 '17-23  <b>Steering Bearing</b> 24.110026 '17-23	<b>Frontbrake Disc</b> 37.BD16290 '17-23  <b>Rearbrake Disc</b> 37.BD26190 '17-23  <b>Front Pad Set</b> 37.102202 '17-23 37.102202BX '17-23 Box of 10  <b>Rear Pad Set</b> 37.202302 '17-23 37.202302BX '17-23 Box of 10  <b>Front Caliper Rebuild Kit</b> 37.63046 '17-23  <b>Front Master Cylinder Rebuild Kit</b> 37.910035 '17-23  <b>Rear Master Cylinder Rebuild Kit</b> 37.910030 '17-23  <b>Brake Pedal Rebuild Kit</b> 37.RBPK003 '17	<b>Front Sprocket</b> 07.FS62093-12 07.FS62093-13 07.FS62093-14 07.FS62093-15 '17-23  <b>7075-T6 Alloy Rear Sprocket</b> 07.RA62090-48 07.RA62090-49 07.RA62090-50 07.RA62090-51 07.RA62090-52 '17-23  <b>Ultralight Steel Rear Sprocket</b> 07.RS62090R-48 07.RS62090R-49 07.RS62090R-50 07.RS62090R-51 07.RS62090R-52 '17-23  <b>Sprocket Bolt Set</b> 07.SBSM825 '17-23	<b>Chain</b> 07.RC520120C '17-23 MX 07.RC520120CG '17-23 MX Gold 07.RC520120XC '17-23 X-Ring 07.RC520120XCG '17-23 X-Ring Gold  <b>Countershaft Seal Kit</b> 26.640001 '17-23	<b>Swingarm</b> 26.210125 '17-23  <b>Upper</b> 26.350059 '17-23  <b>Lower</b> 26.450077 '17-23	<b>Rear Shock Seal Head Kit</b> 26.810120 '17-20
---	--	---	--	--	---	---	--	--

--	--	--	--	--	--	--	--	--

--	--	--	--	--	--	--	--	--

--	--	--	--	--	--	--	--	--

**DIRT**  
APRILIA  
BETA  
BMW  
GAS GAS  
HONDA  
HUSABERG  
HUSQVARNA  
KAWASAKI  
KTM  
MOTO TM  
RIEJU  
SHERCO  
SUZUKI  
YAMAHA

**STREET**  
APRILIA  
CAGIVA  
HONDA  
KAWASAKI  
KTM  
SUZUKI  
YAMAHA

**ATV-UTV**  
CAN-AM  
GAS GAS  
HONDA  
KAWASAKI  
KTM  
POLARIS  
SUZUKI  
YAMAHA

**PWC**  
KAWASAKI  
POLARIS  
SEA DOO  
YAMAHA

**SNOW**  
ARCTIC CAT  
KAWASAKI  
LYNX  
MOTO-SKI  
POLARIS  
SKI DOO  
YAMAHA

**MOPED & SCOOTER**

**MISC. TECH. SPECIAL**



**KTM****DIRT**

APRILIA  
BETA  
BMW  
GAS GAS  
HONDA  
HUSABERG  
HUSQVARNA  
KAWASAKI  
KTM  
MOTO TM  
RIEJU  
SHERCO  
SUZUKI  
YAMAHA

KTM 505 SX-F 4-Stroke Please Note: Nikasil Piston Size -Std. Compression 12.5:1	<b>Piston Kit</b> 01.6508.A 01.6508.B 01.6508.C '08	<b>Size</b> 99.94 99.95 99.96	<b>Ring Set</b> 02.6508 02.6508 02.6508 '08	<b>Crank Bearing &amp; Seal Kit</b> 23.CBS64007 '08	<b>B/E Bearing</b> 22.354220F '08	<b>Complete</b> 34.6508 '08	<b>Cam Chain</b> 31.6427 '08	<b>Valve</b> 28.6427-1 '08 2x Exhaust Titanium 28.6427-2 '08 2x Intake Titanium
Please Note: Nikasil Piston Size -High Compression 13.5:1 -Forged Piston	<b>High Compression</b> 01.6509.A 01.6509.B '08	<b>Size</b> 99.94 99.95	<b>Ring Set</b> 02.6508 02.6508 '08	<b>Bearing</b> 23.NJ206ECP-2 '08 2x	<b>Crankpin</b> 06.3563.9 '09	<b>Top-End</b> 35.6508 '08	<b>Valve Shim Assortment</b> 29.VSA890 '08	<b>Valve Seal</b> 35.VS026 '08 4x
			<b>Pin</b> 04.2045 '08					
			<b>Clips</b> 05.2012 '08					

**STREET**

APRILIA  
CAGIVA  
HONDA  
KAWASAKI  
KTM  
SUZUKI  
YAMAHA

**ATV-UTV**

CAN-AM  
GAS GAS  
HONDA  
KAWASAKI  
KTM  
POLARIS  
SUZUKI  
YAMAHA

**PWC**

KAWASAKI  
POLARIS  
SEA DOO  
YAMAHA

**SNOW**

ARCTIC CAT  
KAWASAKI  
LYNX  
MOTO-SKI  
POLARIS  
SKI DOO  
YAMAHA

**MOPED & SCOOTER****MISC. TECH. SPECIAL**

KTM 505 XC-F 4-Stroke Please Note: Nikasil Piston Size -Std. Compression 12.5:1 -Forged Piston	<b>Piston Kit</b> 01.6508.A 01.6508.B 01.6508.C '09	<b>Size</b> 99.94 99.95 99.96	<b>Ring Set</b> 02.6508 02.6508 02.6508 '09	<b>Crank Bearing &amp; Seal Kit</b> 23.CBS64007 '09	<b>B/E Bearing</b> 22.354220F '09	<b>Complete</b> 34.6508 '09	<b>Cam Chain</b> 31.6427 '09	<b>Valve</b> 28.6427-1 '09 2x Exhaust Titanium 28.6427-2 '09 2x Intake Titanium
Please Note: Nikasil Piston Size -High Compression 13.5:1 -Forged Piston	<b>High Comp.</b> 01.6509.A 01.6509.B '09	<b>Size</b> 99.94 99.95	<b>Ring Set</b> 02.6508 02.6508 '09	<b>Bearing</b> 23.NJ206ECP-2 '09 2x	<b>Crankpin</b> 06.3563.9 '09	<b>Top-End</b> 35.6508 '09	<b>Valve Shim Assortment</b> 29.VSA890 '09	<b>Valve Seal</b> 35.VS026 '09 4x
			<b>Pin</b> 04.2045 '09					
			<b>Clips</b> 05.2012 '09					

Footnotes: \* Bearings Only \*\* Rubbers included

**DIRT**

APRILIA  
BETA  
BMW  
GAS GAS  
HONDA  
HUSABERG  
HUSQVARNA  
KAWASAKI  
KTM  
MOTO TM  
RIEJU  
SHERCO  
SUZUKI  
YAMAHA

**STREET**

APRILIA  
CAGIVA  
HONDA  
KAWASAKI  
KTM  
SUZUKI  
YAMAHA

**ATV-UTV**

CAN-AM  
GAS GAS  
HONDA  
KAWASAKI  
KTM  
POLARIS  
SUZUKI  
YAMAHA

**PWC**

KAWASAKI  
POLARIS  
SEA DOO  
YAMAHA

**SNOW**

ARCTIC CAT  
KAWASAKI  
LYNX  
MOTO-SKI  
POLARIS  
SKI DOO  
YAMAHA

**MOPED & SCOOTER****MISC. TECH. SPECIAL**

<b>Air Filter</b> 52.62007 '08	<b>Basket</b> 17.6427F * '08	<b>Complete Plate Set</b> 16.CPS64007 '08	<b>F/W Bearing</b> 23.S114002 '08	<b>Frontbrake Disc</b> 37.BD16290 '08	<b>Front Sprocket</b> 07.FS62093-12 07.FS62093-13 07.FS62093-14 07.FS62093-15 '08	<b>Chain</b> 07.RC520120C '08 MX 07.RC520120CG '08 MX Gold 07.RC520120XC '08 X-Ring 07.RC520120XCG '08 X-Ring Gold	<b>Swingarm</b> 26.210168 '08	<b>Seal &amp; Wiper</b> 40.S4857.89 '08
<b>Main Jet</b> 45.100-225 '08 Keihin	<b>Clutch Rubber Set</b> 17.CRS1386-8 '08	<b>Friction Set</b> 16.S54015 '08	<b>R/W Bearing</b> 23.S112073 '08	<b>Rearbrake Disc</b> 37.BD26190 '08	<b>7075-T6 Alloy Rear Sprocket</b> 07.RA62090-48 07.RA62090-49 07.RA62090-50 07.RA62090-51 07.RA62090-52 '08	<b>Countershaft Seal Kit</b> 26.640002 '08	<b>Upper</b> 26.350059 '08	<b>Oil Seal Set</b> 40.F4857.89 '08
<b>Pilot Jet</b> 46.040-085 '08 Keihin	<b>Spring Kit</b> 17.CS64042 '08	<b>Steel Set</b> 16.S54006 '08	<b>F/W Spacer Kit</b> 26.710087 '08	<b>Front Pad Set</b> 37.102202 '08			<b>Lower</b> 26.410089 '08	<b>Dust Seal Set</b> 40.F4857.8D '08
<b>Throttle Cable</b> 53.110045 '08	<b>Cover Gasket</b> 19.G6427 '08		<b>R/W Spacer Kit</b> 26.710084 '08	<b>Front Pad Set</b> 37.102202BX '08 Box of 10				<b>Bushing Set</b> 39.160073 '08
<b>Carburetor Rebuild Kit</b> 55.10520 '08	<b>Master Cylinder Rebuild Kit</b> 16.940002 '08		<b>Steering Bearing</b> 24.110026 '08	<b>Rear Pad Set</b> 37.202302 '08				<b>Rear Shock Seal Head Kit</b> 26.810119 '08
<b>Oil Filter</b> 54.63652 '08 1-Pce. 54.63652-50 '08 50-Pcs.	<b>Slave Cylinder Rebuild Kit</b> 16.950004 '08			<b>Ultralight Steel Rear Sprocket</b> 07.RS62090R-48 07.RS62090R-49 07.RS62090R-50 07.RS62090R-51 07.RS62090R-52 '08				
<b>Water Pump Rebuild Kit</b> 57.6528 '08				<b>Sprocket Bolt Set</b> 07.SBSM825 '08				
				<b>Front Master Cylinder Rebuild Kit</b> 37.910024 '08				
				<b>Rear Master Cylinder Rebuild Kit</b> 37.910028 '08				
				<b>Brake Pedal Rebuild Kit</b> 37.RBPK001 '08				





**KTM**

**DIRT**

- APRILIA
- BETA
- BMW
- GAS GAS
- HONDA
- HUSABERG
- HUSQVARNA
- KAWASAKI
- KTM
- MOTO TM
- RIEJU
- SHERCO
- SUZUKI
- YAMAHA

KTM 520 SX - EXC  
4-Stroke  
Please Note:  
Nikasil Piston Size  
-Std. Compression 11.0:1  
-Forged Piston

<b>Piston Kit</b> 01.6521.A 01.6521.B 01.6521.C '00-02	<b>Size</b> 94.94 94.95 94.96	<b>Ring Set</b> 02.6424 02.6424 02.6424 '00-02	<b>Crankbearing &amp; Seal Kit</b> 23.CBS64003 '00-02	<b>Con. Rod Kit</b> 03.6520 '00-02	<b>Complete</b> 34.6520 '00-02	<b>Camshaft Bearing</b> 23.6201-2RS '00-02	<b>Valve</b> 28.6520-1 '00-02 2x Exhaust Steel 28.6520-2 '00-02 2x Intake Steel
		<b>Clips</b> 05.2012 '00-02	<b>Bearing</b> 23.NJ206ECP-1 '00-02 2x	<b>B/E Bearing</b> 22.354322F '00-02	<b>Top-End</b> 35.6520 '00-02		<b>Valve Seal</b> 35.VS026 '00-02 4x
			<b>Crankseal</b> 41.6-304772 '00-02 1x Right	<b>Crankpin</b> 06.3564.7 '00-02	<b>Ignition Cover Gasket</b> 19.G96403 '00-02		

**STREET**

- APRILIA
- CAGIVA
- HONDA
- KAWASAKI
- KTM
- SUZUKI
- YAMAHA

**ATV-UTV**

- CAN-AM
- GAS GAS
- HONDA
- KAWASAKI
- KTM
- POLARIS
- SUZUKI
- YAMAHA

**PWC**

- KAWASAKI
- POLARIS
- SEA DOO
- YAMAHA

**SNOW**

- ARCTIC CAT
- KAWASAKI
- LYNX
- MOTO-SKI
- POLARIS
- SKI DOO
- YAMAHA

**MOPED & SCOOTER**

**MISC. TECH. SPECIAL**

**DIRT**

- APRILIA
- BETA
- BMW
- GAS GAS
- HONDA
- HUSABERG
- HUSQVARNA
- KAWASAKI
- KTM
- MOTO TM
- RIEJU
- SHERCO
- SUZUKI
- YAMAHA

**STREET**

- APRILIA
- CAGIVA
- HONDA
- KAWASAKI
- KTM
- SUZUKI
- YAMAHA

**ATV-UTV**

- CAN-AM
- GAS GAS
- HONDA
- KAWASAKI
- KTM
- POLARIS
- SUZUKI
- YAMAHA

**PWC**

- KAWASAKI
- POLARIS
- SEA DOO
- YAMAHA

**SNOW**

- ARCTIC CAT
- KAWASAKI
- LYNX
- MOTO-SKI
- POLARIS
- SKI DOO
- YAMAHA

**MOPED & SCOOTER**

**MISC. TECH. SPECIAL**

<b>Air Filter</b> 52.62098 '00 52.62004 '01-02	<b>Spring Kit</b> 17.CS65041 '00-02	<b>Complete Plate Set</b> 16.CPS65002 '02	<b>F/W Bearing</b> 23.S110080 '00 23.S110080 '01-02 EXC 23.S110081 '01-02 SX	<b>Frontbrake Disc</b> 37.BD16290 '00-02	<b>Front Sprocket</b> 07.FS62093-12 07.FS62093-13 07.FS62093-14 07.FS62093-15 '00-02	<b>Chain</b> 07.RC520120C '00-02 MX 07.RC520120CG '00-02 MX Gold 07.RC520120XC '00-02 X-Ring 07.RC520120XCG '00-02 X-Ring Gold	<b>Swingarm</b> 26.210087 '00-02	<b>Seal &amp; Wiper</b> 40.S4352.99P '00-02
<b>Main Jet</b> 45.100-225 '00-02 Keihin	<b>Cover Gasket</b> 19.G6520 '00-02	<b>Friction Set</b> 16.S54008 '00-02	<b>R/W Bearing</b> 23.S112073 '00-02	<b>Rearbrake Disc</b> 37.BD26190 '00-02	<b>7075-T6 Alloy Rear Sprocket</b> 07.RA62090-48 07.RA62090-49 07.RA62090-50 07.RA62090-51 07.RA62090-52 '00-02	<b>Upper</b> 26.350059 '02	<b>Oil Seal Set</b> 40.F4352.99P '00-02	
<b>Pilot Jet</b> 46.040-085 '00-02 Keihin	<b>Master Cylinder Rebuild Kit</b> 16.940001 '00-02	<b>Steel Set</b> 16.S54010 '02	<b>F/W Spacer Kit</b> 26.710089 '00-02 SX 26.710088 '00-02 EXC	<b>Front Pad Set</b> 37.102202 '00-02 37.102202BX '00-02 Box of 10	<b>Countershaft Seal Kit</b> 26.640001 '00-02	<b>Lower</b> 26.410089 '00-02	<b>Dust Seal Set</b> 40.F4353.4DP '00-02	
<b>Throttle Cable</b> 53.110044 '00-02	<b>Slave Cylinder Rebuild Kit</b> 16.950008 '00-02		<b>R/W Spacer Kit</b> 26.710084 '00-02	<b>Rear Pad Set</b> 37.204202 '00-02 37.204202BX '00-02 Box of 10	<b>Lower Chain Roller</b> 33.0003 '00-02	<b>Rear Shock Seal Head Kit</b> 26.810119 '00-02		
<b>Carburetor Rebuild Kit</b> 55.10515 '00-02			<b>Steering Bearing</b> 24.110026 '00-02	<b>Front Caliper Rebuild Kit</b> 37.63047 '00-02	<b>Upper Chain Roller</b> 33.0003 '00-02			
<b>Oil Filter #1</b> 54.63655 '00-02 1-Pce. 54.63655-50 '00-02 50-Pcs.				<b>Rear Caliper Rebuild Kit</b> 37.63050 '01-02 EXC	<b>Sprocket Bolt Set</b> 07.SBSM825 '00-02			
<b>Oil Filter #2</b> 54.64157 '00-02 1-Pce. 54.64157-50 '00-02 50-Pcs.				<b>Front Master Cylinder Rebuild Kit</b> 37.910023 '00-02				
<b>Water Pump Rebuild Kit</b> 57.6322 '00-02				<b>Rear Master Cylinder Rebuild Kit</b> 37.910029 '01-02				
				<b>Brake Pedal Rebuild Kit</b> 37.RBPK002 '00-02				

Footnotes: \* Bearings Only \*\* Rubbers included





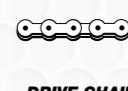

**KTM**

**DIRT**  
APRILIA  
BETA  
BMW  
GAS GAS  
HONDA  
HUSABERG  
HUSQVARNA  
KAWASAKI  
KTM  
MOTO TM  
RIEJU  
SHERCO  
SUZUKI  
YAMAHA

KTM 525 SX - EXC Racing  
4-Stroke  
Please Note:  
Nikasil Piston Size  
-Std. Compression 11.0:1  
-Forged Piston

<b>Piston Kit</b> 01.6521.A 01.6521.B 01.6521.C '03-07	<b>Size</b> 94.94 94.95 94.96	<b>Ring Set</b> 02.6424 02.6424 02.6424 '03-07	<b>CrankBearing &amp; Seal Kit</b> 23.CBS64003 '03-07	<b>Con. Rod Kit</b> 03.6520 '03-07	<b>Complete</b> 34.6520 '03-07	<b>Camshaft Bearing</b> 23.6201-2RS '03-07	<b>Valve</b> 28.6520-1 '03-07 2x Exhaust Steel 28.6520-2 '03-07 2x Intake Steel
		<b>Clips</b> 05.2012 '03-07	<b>Bearing</b> 23.NJ206ECP-1 '03-07 2x	<b>B/E Bearing</b> 22.354322F '03-07	<b>Top-End</b> 35.6520 '03-07		<b>Valve Seal</b> 35.VS026 '03-07 4x
			<b>Crankpin</b> 06.3564.7 '03-07		<b>Ignition Cover Gasket</b> 19.G96403 '03-07		

**STREET**  
APRILIA  
CAGIVA  
HONDA  
KAWASAKI  
KTM  
SUZUKI  
YAMAHA

**ATV-UTV**  
CAN-AM  
GAS GAS  
HONDA  
KAWASAKI  
KTM  
POLARIS  
SUZUKI  
YAMAHA

**PWC**  
KAWASAKI  
POLARIS  
SEA DOO  
YAMAHA

**SNOW**  
ARCTIC CAT  
KAWASAKI  
LYNX  
MOTO-SKI  
POLARIS  
SKI DOO  
YAMAHA

**MOPED & SCOOTER**

**MISC. TECH. SPECIAL**

**DIRT**  
APRILIA  
BETA  
BMW  
GAS GAS  
HONDA  
HUSABERG  
HUSQVARNA  
KAWASAKI  
KTM  
MOTO TM  
RIEJU  
SHERCO  
SUZUKI  
YAMAHA

**STREET**  
APRILIA  
CAGIVA  
HONDA  
KAWASAKI  
KTM  
SUZUKI  
YAMAHA

**ATV-UTV**  
CAN-AM  
GAS GAS  
HONDA  
KAWASAKI  
KTM  
POLARIS  
SUZUKI  
YAMAHA

**PWC**  
KAWASAKI  
POLARIS  
SEA DOO  
YAMAHA

**SNOW**  
ARCTIC CAT  
KAWASAKI  
LYNX  
MOTO-SKI  
POLARIS  
SKI DOO  
YAMAHA

**MOPED & SCOOTER**

**MISC. TECH. SPECIAL**

<b>Air Filter</b> 52.62004 '03-07	<b>Spring Kit</b> 17.CS65041 '03-07	<b>Complete Plate Set</b> 16.CPS65002 '03	<b>F/W Bearing</b> 23.S114002 '03-07	<b>Frontbrake Disc</b> 37.BD16290 '03-07	<b>Front Sprocket</b> 07.FS62093-12 07.FS62093-13 07.FS62093-14 07.FS62093-15 '03-07	<b>Chain</b> 07.RC520120C '03-07 MX 07.RC520120CG '03-07 MX Gold 07.RC520120XC '03-07 X-Ring 07.RC520120XCG '03-07 X-Ring Gold	<b>Swingarm</b> 26.210087 '03 26.210125 '04-07	<b>Seal &amp; Wiper</b> 40.S4857.89 '03-07
<b>Main Jet</b> 45.100-225 '03-07 Keihin	<b>Cover Gasket</b> 19.G6520 '03-07	<b>16.CPS64004</b> '04-05 <b>16.CPS64006</b> '06-07	<b>R/W Bearing</b> 23.S112073 '03-07	<b>Rearbrake Disc</b> 37.BD26190 '03-07	<b>7075-T6 Alloy Rear Sprocket</b> 07.RA62090-48 07.RA62090-49 07.RA62090-50 07.RA62090-51 07.RA62090-52 '03-07	<b>Upper</b> 26.350059 '03-07	<b>Oil Seal Set</b> 40.F4857.89 '03-07	
<b>Pilot Jet</b> 46.040-085 '03-07 Keihin	<b>Master Cylinder Rebuild Kit</b> 16.940001 '03	<b>Friction Set</b> 16.S54008 '03 <b>16.S54007</b> '04-07	<b>F/W Spacer Kit</b> 26.710087 '03-07	<b>Front Pad Set</b> 37.102202 '03-07 <b>37.102202BX</b> '03-07 Box of 10	<b>7075-T6 Alloy Rear Sprocket</b> 07.RA62090-48 07.RA62090-49 07.RA62090-50 07.RA62090-51 07.RA62090-52 '03-07	<b>Lower</b> 26.410089 '03-07	<b>Dust Seal Set</b> 40.F4857.8D '03-07	
<b>Throttle Cable</b> 53.110043 '03-07	<b>16.940004</b> '04-06 <b>16.940000</b> '07 EXC	<b>Steel Set</b> 16.S54010 '03 + '06-07 <b>16.S54009</b> '04-05	<b>R/W Spacer Kit</b> 26.710084 '03-07	<b>Rear Pad Set</b> 37.204202 '03 <b>37.204202BX</b> '03 Box of 10 <b>37.202302</b> '04-07 <b>37.202302BX</b> '04-07 Box of 10	<b>UltraLight Steel Rear Sprocket</b> 07.RS62090R-48 07.RS62090R-49 07.RS62090R-50 07.RS62090R-51 07.RS62090R-52 '03-07	<b>Countershaft Seal Kit</b> 26.640001 '03-07	<b>Bushing Set</b> 39.160077 '03-04 <b>39.160054</b> '05-07	
<b>Carburetor Rebuild Kit</b> 55.10521 '03-05 <b>55.10520</b> '06-07	<b>Slave Cylinder Rebuild Kit</b> 16.950009 '03-06 <b>16.950002</b> '07 EXC		<b>Steering Bearing</b> 24.110026 '03-07	<b>Front Caliper Rebuild Kit</b> 37.63047 '03-06 SX <b>37.63047</b> '03-07 EXC	<b>Sprocket Bolt Set</b> 07.SBSM825 '03-07	<b>Upper Chain Roller</b> 33.0003 '03-07	<b>Rear Shock Seal Head Kit</b> 26.810119 '03-07	
<b>Oil Filter #1</b> 54.63655 '03-07 1-Pce. <b>54.63655-50</b> '03-07 50-Pcs.				<b>Rear Caliper Rebuild Kit</b> 37.63048 '04-06 SX <b>37.63050</b> '03 EXC <b>37.63048</b> '04-07 EXC				
<b>Oil Filter #2</b> 54.64157 '03-07 1-Pce. <b>54.64157-50</b> '03-07 50-Pcs.				<b>Front Master Cylinder Rebuild Kit</b> 37.910023 '03-04 <b>37.910022</b> '05 <b>37.910024</b> '06-07				
<b>Water Pump Rebuild Kit</b> 57.6322 '03-07				<b>Rear Master Cylinder Rebuild Kit</b> 37.910029 '03 <b>37.910028</b> '04-07				
				<b>Brake Pedal Rebuild Kit</b> 37.RBPK002 '03 <b>37.RBPK001</b> '04-07				

Footnotes: \* Bearings Only \*\* Rubbers included



**KTM**

**DIRT**  
APRILIA  
BETA  
BMW  
GAS GAS  
HONDA  
HUSABERG  
HUSQVARNA  
KAWASAKI  
KTM  
MOTO TM  
RIEJU  
SHERCO  
SUZUKI  
YAMAHA

KTM 525 SM-R 4-Stroke Please Note: Nikasil Piston Size -Std. Compression 11.0:1 -Forged Piston	<b>Piston Kit</b> 01.6521.A 01.6521.B 01.6521.C '04-05	<b>Size</b> 94.94 94.95 94.96	<b>Ring Set</b> 02.6424 02.6424 02.6424 '04-05	<b>CrankBearing &amp; Seal Kit</b> 23.CBS64003 '04-05	<b>Con. Rod Kit</b> 03.6520 '04-05	<b>Complete</b> 34.6520 '04-05	<b>Camshaft Bearing</b> 23.6201-2RS '04-05	<b>Valve</b> 28.6423-1 '04-05 2x Exhaust Titanium 28.6423-2 '04-05 2x Intake Titanium	<b>Valve Seal</b> 35.VS026 '04-05 4x
			<b>Clips</b> 05.2012 '04-05	<b>Bearing</b> 23.NJ206ECP-1 '04-05 2x	<b>B/E Bearing</b> 22.354322F '04-05	<b>Top-End</b> 35.6520 '04-05			
					<b>Crankpin</b> 06.3564.7 '04-05				

**STREET**  
APRILIA  
CAGIVA  
HONDA  
KAWASAKI  
KTM  
SUZUKI  
YAMAHA

KTM 530 EXC-R 4-Stroke Please Note: Nikasil Piston Size -Std. Compression 11.9:1 -Forged Piston	<b>Piston Kit</b> 01.6528.A 01.6528.B 01.6528.C '08-11	<b>Size</b> 94.94 94.95 94.96	<b>Ring Set</b> 02.6429 02.6429 02.6429 '08-11	<b>CrankBearing &amp; Seal Kit</b> 23.CBS64012 '09-11	<b>Con. Rod Kit</b> 03.6528 '08-11	<b>Complete</b> 34.6438 '08-11	<b>Cam Chain</b> 31.6508 '08-11	<b>Valve</b> 28.6428-1 '08-11 2x Exhaust Steel 28.6428-2 '08-11 2x Intake Titanium	<b>Valve Seal</b> 35.VS026 '08-11 2x Intake 35.VS028 '08-11 2x Exhaust
			<b>Pin</b> 04.1947.5 '08-11	<b>Bearing</b> 23.SX07E39 '08-11 2x	<b>B/E Bearing</b> 22.354220F '08-11	<b>Top-End</b> 35.6438 '08-11	<b>Valve Shim Assortment</b> 29.VSA1000 '08-11		
			<b>Clips</b> 05.1912 '08-11	<b>Oilseal Set</b> 42.6432 '09-11	<b>Crankpin</b> 06.3562.7 '08-11	<b>Ignition Cover Gasket</b> 19.G96408 '08-11			

**PWC**  
KAWASAKI  
POLARIS  
SEA DOO  
YAMAHA

--	--	--	--	--	--	--	--	--	--

**SNOW**  
ARCTIC CAT  
KAWASAKI  
LYNX  
MOTO-SKI  
POLARIS  
SKI DOO  
YAMAHA

--	--	--	--	--	--	--	--	--	--

**MOPED & SCOOTER**

--	--	--	--	--	--	--	--	--	--

**MISC. TECH. SPECIAL**

--	--	--	--	--	--	--	--	--	--

Footnotes: \* Bearings Only \*\* Rubbers included

**DIRT**  
APRILIA  
BETA  
BMW  
GAS GAS  
HONDA  
HUSABERG  
HUSQVARNA  
KAWASAKI  
KTM  
MOTO TM  
RIEJU  
SHERCO  
SUZUKI  
YAMAHA

<b>Air Filter</b> 52.62004 '04-05	<b>Spring Kit</b> 17.CS65041 '04-05	<b>Complete Plate Set</b> 16.CPS64004 '04-05	<b>F/W Bearing</b> 23.S114002 '04-05	<b>Rearbrake Disc</b> 37.BD26190 '04-05	<b>Front Sprocket</b> 07.FS62093-12 07.FS62093-13 07.FS62093-14 07.FS62093-15 '04-05	<b>Chain</b> 07.RC520120C '04-05 MX 07.RC520120CG '04-05 MX Gold 07.RC520120XC '04-05 X-Ring 07.RC520120XCG '04-05 X-Ring Gold	<b>Swingarm</b> 26.210125 '04-05	<b>Seal &amp; Wiper</b> 40.S4857.89 '04-05
<b>Main Jet</b> 45.100-225 '04-05 Keihin	<b>Cover Gasket</b> 19.G6520 '04-05	<b>Friction Set</b> 16.S54007 '04-05	<b>R/W Bearing</b> 23.S112073 '04-05	<b>Rear Pad Set</b> 37.202302 '04-05 37.202302BX '04-05 Box of 10	<b>7075-T6 Alloy Rear Sprocket</b> 07.RA62090-48 07.RA62090-49 07.RA62090-50 07.RA62090-51 07.RA62090-52 '04-05	<b>Upper</b> 26.350059 '04-05	<b>Oil Seal Set</b> 40.F4857.89 '04-05	
<b>Pilot Jet</b> 46.040-085 '04-05 Keihin	<b>Master Cylinder Rebuild Kit</b> 16.940004 '05	<b>Steel Set</b> 16.S54009 '04-05	<b>F/W Spacer Kit</b> 26.710087 '04-05	<b>Rear Caliper Rebuild Kit</b> 37.63048 '05	<b>Countershaft Seal Kit</b> 26.640001 '05	<b>Lower</b> 26.410089 '04-05	<b>Dust Seal Set</b> 40.F4857.8D '04-05	
<b>Throttle Cable</b> 53.110043 '05	<b>Slave Cylinder Rebuild Kit</b> 16.950009 '05		<b>R/W Spacer Kit</b> 26.710084 '04-05	<b>Rear Master Cylinder Rebuild Kit</b> 37.910022 '05	<b>Upper Chain Roller</b> 33.0003 '05		<b>Bushing Set</b> 39.160054 '05	
<b>Carburetor Rebuild Kit</b> 55.10521 '05			<b>Steering Bearing</b> 24.110026 '04-05	<b>Front Master Cylinder Rebuild Kit</b> 37.910022 '05	<b>Ultralight Steel Rear Sprocket</b> 07.RS62090R-48 07.RS62090R-49 07.RS62090R-50 07.RS62090R-51 07.RS62090R-52 '04-05		<b>Rear Shock Seal Head Kit</b> 26.810119 '05	
<b>Oil Filter #1</b> 54.63655 '04-05 1-Pce. 54.63655-50 '04-05 50-Pcs.				<b>Rear Master Cylinder Rebuild Kit</b> 37.910028 '05	<b>Sprocket Bolt Set</b> 07.SBSM825 '04-05			
<b>Oil Filter #2</b> 54.64157 '04-05 1-Pce. 54.64157-50 '04-05 50-Pcs.				<b>Brake Pedal Rebuild Kit</b> 37.RBPK001 '04-05				

**STREET**  
APRILIA  
CAGIVA  
HONDA  
KAWASAKI  
KTM  
SUZUKI  
YAMAHA

<b>Air Filter</b> 52.62007 '08-09 52.62010 '10-11	<b>Basket</b> 17.6427F * '08-11	<b>Complete Plate Set</b> 16.CPS65008 '08	<b>F/W Bearing</b> 23.S114002 '08-11	<b>Frontbrake Disc</b> 37.BD16290 '08-11	<b>Front Sprocket</b> 07.FS62093-12 07.FS62093-13 07.FS62093-14 07.FS62093-15 '08-11	<b>Chain</b> 07.RC520120C '08-11 MX 07.RC520120CG '08-11 MX Gold 07.RC520120XC '08-11 X-Ring 07.RC520120XCG '08-11 X-Ring Gold	<b>Swingarm</b> 26.210125 '08-11	<b>Seal &amp; Wiper</b> 40.S4857.89 '08-11
<b>Main Jet</b> 45.100-225 '08-11 Keihin	<b>Clutch Rubber Set</b> 17.CRS1386-8 '08-11	<b>16.CPS64009</b> '09	<b>R/W Bearing</b> 23.S112073 '08-11	<b>Rearbrake Disc</b> 37.BD26190 '08-11	<b>7075-T6 Alloy Rear Sprocket</b> 07.RA62090-48 07.RA62090-49 07.RA62090-50 07.RA62090-51 07.RA62090-52 '08-11	<b>Upper</b> 26.350059 '08-11	<b>Oil Seal Set</b> 40.F4857.89 '08-11	
<b>Pilot Jet</b> 46.040-085 '08-11 Keihin	<b>Spring Kit</b> 17.CS64049 '08-11	<b>Friction Set</b> 16.S54016 '08	<b>F/W Spacer Kit</b> 26.710087 '08-11	<b>Front Pad Set</b> 37.102202 '08-11 37.102202BX '08-11 Box of 10	<b>Countershaft Seal Kit</b> 26.640001 '08-11	<b>Lower</b> 26.410089 '08-11	<b>Dust Seal Set</b> 40.F4857.8D '08-11	
<b>Throttle Cable</b> 53.110045 '08-11	<b>Master Cylinder Rebuild Kit</b> 16.940000 '08-11	<b>Steel Set</b> 16.S54020 '08	<b>R/W Spacer Kit</b> 26.710084 '08-11	<b>Rear Pad Set</b> 37.202302 '08-11 37.202302BX '08-11 Box of 10	<b>Ultralight Steel Rear Sprocket</b> 07.RS62090R-48 07.RS62090R-49 07.RS62090R-50 07.RS62090R-51 07.RS62090R-52 '08-11		<b>Bushing Set</b> 39.160074 '08-11	
<b>Carburetor Rebuild Kit</b> 55.10520 '08-11	<b>Slave Cylinder Rebuild Kit</b> 16.950005 '08-11	<b>16.S54021</b> '09-11	<b>Steering Bearing</b> 24.110026 '08-11	<b>Front Caliper Rebuild Kit</b> 37.63047 '08-09 37.63046 '11	<b>Sprocket Bolt Set</b> 07.SBSM825 '08-11		<b>Rear Shock Seal Head Kit</b> 26.810119 '08-11	
<b>Oil Filter</b> 54.63652 '08-11 1-Pce. 54.63652-50 '08-11 50-Pcs.				<b>Rear Caliper Rebuild Kit</b> 37.63048 '08-11				
<b>Water Pump Rebuild Kit</b> 57.6429 '08-11				<b>Cylinder Rebuild Kit</b> 37.910024 '08-09 37.910026 '10-11				
				<b>Rear Master Cylinder Rebuild Kit</b> 37.910028 '08-11				
				<b>Brake Pedal Rebuild Kit</b> 37.RBPK001 '08-11				

**ATV-UTV**  
CAN-AM  
GAS GAS  
HONDA  
KAWASAKI  
KTM  
POLARIS  
SUZUKI  
YAMAHA

--	--	--	--	--	--	--	--	--

**PWC**  
KAWASAKI  
POLARIS  
SEA DOO  
YAMAHA

--	--	--	--	--	--	--	--	--

**SNOW**  
ARCTIC CAT  
KAWASAKI  
LYNX  
MOTO-SKI  
POLARIS  
SKI DOO  
YAMAHA

--	--	--	--	--	--	--	--	--

**MOPED & SCOOTER**

--	--	--	--	--	--	--	--	--

**MISC. TECH. SPECIAL**



PISTON KITS

SIZES (mm)

PISTON PARTS

CRANKSHAFT PARTS

CONNECTING ROD PARTS

GASKETS

VALVE TRAIN PARTS I

VALVE TRAIN PARTS II

AIR & FUEL PARTS

CLUTCH PARTS

CLUTCH PLATE SETS

WHEEL & STEERING PARTS

BRAKE PARTS

DRIVE CHAIN PARTS I

DRIVE CHAIN PARTS II

SUSPENSION BEARING KITS

SUSPENSION PARTS

**KTM**

**DIRT**  
APRILIA  
BETA  
BMW  
GAS GAS  
HONDA  
HUSABERG  
HUSQVARNA  
KAWASAKI  
KTM  
MOTO TM  
RIEJU  
SHERCO  
SUZUKI  
YAMAHA

KTM 560 SM-R  
4-Stroke  
-Forged Piston

**Piston Kit**  
-

**Size**  
100.00

**Ring Set**  
-  
**Clips**  
05.2015  
'06-07

**CrankBearing & Seal Kit**  
23.CBS64003  
'06-07  
**Bearing**  
23.NJ206ECP-1  
'06-07 2x

**Camshaft Bearing**  
23.6201-2RS  
'06-07

**Valve**  
28.6423-1  
'06-07 2x Exhaust  
Titanium  
28.6423-2  
'06-07 2x Intake  
Titanium  
**Valve Seal**  
35.VS026  
'06-07 4x

**STREET**  
APRILIA  
CAGIVA  
HONDA  
KAWASAKI  
KTM  
SUZUKI  
YAMAHA

KTM 620 LC4  
4-Stroke  
Please Note:  
Nikasil Piston Size  
-Std. Compression 11.7:1  
-Forged Piston

**Piston Kit**  
01.6604.A  
01.6604.B  
01.6604.C  
'94-97

**Size**  
100.94  
100.95  
100.96

**Ring Set**  
02.5594.100  
02.5594.100  
02.5594.100  
'94-97  
**Clips**  
05.2216  
'94-97

**Con. Rod Kit**  
03.6519  
'94-97  
**B/E Bearing**  
22.405023F  
'94-97  
**Crankpin**  
06.4065  
'94-97

**PWC**  
KAWASAKI  
POLARIS  
SEA DOO  
YAMAHA

**SNOW**  
ARCTIC CAT  
KAWASAKI  
LYNX  
MOTO-SKI  
POLARIS  
SKI DOO  
YAMAHA

**MOPED & SCOOTER**

**MISC. TECH. SPECIAL**

Footnotes: \* Bearings Only \*\* Rubbers included

**DIRT**  
APRILIA  
BETA  
BMW  
GAS GAS  
HONDA  
HUSABERG  
HUSQVARNA  
KAWASAKI  
KTM  
MOTO TM  
RIEJU  
SHERCO  
SUZUKI  
YAMAHA

**Air Filter**  
52.62004  
'06-07  
**Main Jet**  
45.100-225  
'06-07 Keihin  
**Pilot Jet**  
46.040-085  
'06-07 Keihin  
**Throttle Cable**  
53.110043  
'06-07  
**Carburetor Rebuild Kit**  
55.10521  
'06-07  
**Oil Filter #1**  
54.63655  
'06-07 1-Pce.  
54.63655-50  
'06-07 50-Pcs.  
**Oil Filter #2**  
54.64157  
'06-07 1-Pce.  
54.64157-50  
'06-07 50-Pcs.

**Spring Kit**  
17.CS65041  
'06-07  
**Cover Gasket**  
19.G6520  
'06-07  
**Master Cylinder Rebuild Kit**  
16.940004  
'06-07  
**Slave Cylinder Rebuild Kit**  
16.950009  
'06-07

**Complete Plate Set**  
16.CPS64006  
'06-07  
**Friction Set**  
16.S54007  
'06-07  
**Steel Set**  
16.S54010  
'06-07

**F/W Bearing**  
23.S114002  
'06-07  
**R/W Bearing**  
23.S112073  
'06-07  
**F/W Spacer Kit**  
26.710087  
'06-07  
**R/W Spacer Kit**  
26.710084  
'06-07  
**Steering Bearing**  
24.110026  
'06-07

**Rearbrake Disc**  
37.BD26190  
'06-07  
**Rear Pad Set**  
37.202302  
'06-07  
37.202302BX  
'06-07 Box of 10  
**Rear Master Cylinder Rebuild Kit**  
37.910028  
'06

**Front Sprocket**  
07.FS62093-12  
07.FS62093-13  
07.FS62093-14  
07.FS62093-15  
'06-07  
**7075-T6 Alloy Rear Sprocket**  
07.RA62090-48  
07.RA62090-49  
07.RA62090-50  
07.RA62090-51  
07.RA62090-52  
'06-07  
**Ultralight Steel Rear Sprocket**  
07.RS62090R-48  
07.RS62090R-49  
07.RS62090R-50  
07.RS62090R-51  
07.RS62090R-52  
'06-07  
**Sprocket Bolt Set**  
07.SBSM825  
'06-07

**Chain**  
07.RC520120C  
'06-07 MX  
07.RC520120CG  
'06-07 MX Gold  
07.RC520120XC  
'06-07 X-Ring  
07.RC520120XCG  
'06-07 X-Ring Gold  
**Upper Chain Roller**  
33.0003  
'06-07

**Swingarm**  
26.210125  
'06-07  
**Upper**  
26.350059  
'06-07  
**Lower**  
26.410089  
'06-07

**Seal & Wiper**  
40.S4857.89  
'06-07  
**Oil Seal Set**  
40.F4857.89  
'06-07  
**Dust Seal Set**  
40.F4857.8D  
'06-07  
**Bushing Set**  
39.160054  
'06-07  
**Rear Shock Seal Head Kit**  
26.810119  
'06-07

**STREET**  
APRILIA  
CAGIVA  
HONDA  
KAWASAKI  
KTM  
SUZUKI  
YAMAHA

**F/W Bearing**  
23.S110061  
'95-97  
**R/W Bearing**  
23.S112083  
'95-97  
**Steering Bearing**  
24.110026  
'94-97

**Front Pad Set**  
37.102202  
'94-01  
37.102202BX  
'94-01 Box of 10  
**Rear Pad Set**  
37.204202  
'94-01  
37.204202BX  
'94-01 Box of 10  
**Front Master Cylinder Rebuild Kit**  
37.910025  
'94-97  
**Rear Master Cylinder Rebuild Kit**  
37.910029  
'94-97

**Front Sprocket**  
07.FS66088-14  
07.FS66088-15  
07.FS66088-16  
'95-97  
**7075-T6 Alloy Rear Sprocket**  
07.RA62090-48  
07.RA62090-49  
07.RA62090-50  
07.RA62090-51  
07.RA62090-52  
'94-01  
**Ultralight Steel Rear Sprocket**  
07.RS62090R-48  
07.RS62090R-49  
07.RS62090R-50  
07.RS62090R-51  
07.RS62090R-52  
'94-01  
**Sprocket Bolt Set**  
07.SBSM825  
'94-01

**Chain**  
07.RC520120C  
'94-01 MX  
07.RC520120CG  
'94-01 MX Gold  
07.RC520120XC  
'94-01 X-Ring  
07.RC520120XCG  
'94-01 X-Ring Gold

**Swingarm**  
26.210087  
'94-97

**ATV-UTV**  
CAN-AM  
GAS GAS  
HONDA  
KAWASAKI  
KTM  
POLARIS  
SUZUKI  
YAMAHA

**PWC**  
KAWASAKI  
POLARIS  
SEA DOO  
YAMAHA

**SNOW**  
ARCTIC CAT  
KAWASAKI  
LYNX  
MOTO-SKI  
POLARIS  
SKI DOO  
YAMAHA

**MOPED & SCOOTER**

**MISC. TECH. SPECIAL**



KTM		Piston Kit	Size	Ring Set	Bearing	Con. Rod Kit	B/E Bearing	Crankpin
<b>DIRT</b> KTM 620 SC 4-Stroke Please Note: Nikasil Piston Size -Std. Compression 11.7:1 -Forged Piston	<b>APRILIA</b>	01.6604.A	100.94	02.5594.100	23.NJ207ECS	03.6519	22.405023F	06.4065
	<b>BETA</b>	01.6604.B	100.95	02.5594.100	'02-07 Right	'98-01	'98-01	'98-01
<b>GAS GAS</b>	<b>BMW</b>	01.6604.C	100.96	02.5594.100	23.NJ306C3	03.6519	22.405023F	06.4065
	<b>HONDA</b>	'98-01		'98-01	'02-07 Left	'98-01	'02-07	'98-01
<b>HUSABERG</b>	<b>HUSQVARNA</b>							
	<b>KAWASAKI</b>							
<b>MOTO TM</b>	<b>RIEJU</b>							
	<b>SHERCO</b>							
<b>SUZUKI</b>	<b>YAMAHA</b>							
<b>STREET</b>	<b>APRILIA</b>							
	<b>CAGIVA</b>							
<b>HONDA</b>	<b>KAWASAKI</b>							
	<b>KTM</b>							
<b>SUZUKI</b>	<b>YAMAHA</b>							
<b>ATV-UTV</b>	<b>CAN-AM</b>							
	<b>GAS GAS</b>							
<b>HONDA</b>	<b>KAWASAKI</b>							
	<b>KTM</b>							
<b>POLARIS</b>	<b>SUZUKI</b>							
	<b>YAMAHA</b>							
<b>PWC</b>	<b>KAWASAKI</b>							
	<b>POLARIS</b>							
<b>SEA DOO</b>	<b>YAMAHA</b>							
<b>SNOW</b>	<b>ARCTIC CAT</b>							
	<b>KAWASAKI</b>							
<b>LYNX</b>	<b>MOTO-SKI</b>							
	<b>POLARIS</b>							
<b>SKI DOO</b>	<b>YAMAHA</b>							
<b>MOPED &amp; SCOOTER</b>								
<b>MISC. TECH. SPECIAL</b>								

Footnotes: \* Bearings Only \*\* Rubbers included

F/W Bearing	Front Pad Set	Front Sprocket	Chain	Swingarm	Seal & Wiper
23.S110061 '98-01	37.102202 '94-01	07.FS66088-14 07.FS66088-15 07.FS66088-16 '98-01	07.RC520120C '94-01 MX 07.RC520120CG '94-01 MX Gold 07.RC520120XC '94-01 X-Ring 07.RC520120XCG '94-01 X-Ring Gold	26.210087 '98-01	40.S4857.89 '02-07
R/W Bearing 23.S112083 '98-01	37.102202BX '94-01 Box of 10	7075-T6 Alloy Rear Sprocket 07.RA62090-48 07.RA62090-49 07.RA62090-50 07.RA62090-51 07.RA62090-52 '94-01	07.RC520120CG '02-07 MX Gold 07.RC520120XC '02-07 X-Ring 07.RC520120XCG '02-07 X-Ring Gold		Oil Seal Set 40.F4857.89 '02-07
Steering Bearing 24.110026 '98-01	Rear Pad Set 37.204202 '94-01	07.RS62090R-48 07.RS62090R-49 07.RS62090R-50 07.RS62090R-51 07.RS62090R-52 '94-01			Dust Seal Set 40.F4858.8D '02-07
	37.204202BX '94-01 Box of 10	Ultralight Steel Rear Sprocket 07.RS62090R-48 07.RS62090R-49 07.RS62090R-50 07.RS62090R-51 07.RS62090R-52 '94-01			Bushing Set 39.160054 '05
		Sprocket Bolt Set 07.SBSM825 '94-01			
Air Filter 52.61097 '02-07	Spring Kit 17.CS66044 '02-07	Friction Set 16.S56016 '02-07	Steering Bearing 24.110026 '02-07	Front Pad Set 37.102202 '02-07	Front Sprocket 07.FS66088-14 07.FS66088-15 07.FS66088-16 '02-07
Throttle Cable 53.110043 '04	Master Cylinder Rebuild Kit 16.940002 '04-06			37.102202BX '02-07 Box of 10	07.RC520120CG '02-07 MX Gold 07.RC520120XC '02-07 X-Ring 07.RC520120XCG '02-07 X-Ring Gold
Oil Filter #1 54.63655 '03-04 1-Pce. 54.63655-50 '03-04 50-Pcs.	Slave Cylinder Rebuild Kit 16.950011 '03-06			Rear Pad Set 37.204202 '02-04	7075-T6 Alloy Rear Sprocket 07.RA62090-48 07.RA62090-49 07.RA62090-50 07.RA62090-51 07.RA62090-52 '02-07
Oil Filter #2 54.64157 '03-04 1-Pce. 54.64157-50 '03-04 50-Pcs.				37.204202BX '02-04 Box of 10	07.RA62090-48 07.RA62090-49 07.RA62090-50 07.RA62090-51 07.RA62090-52 '02-07
				37.202302 '05-07	Ultralight Steel Rear Sprocket 07.RS62090R-48 07.RS62090R-49 07.RS62090R-50 07.RS62090R-51 07.RS62090R-52 '02-07
				37.202302BX '05-07 Box of 10	07.RS62090R-48 07.RS62090R-49 07.RS62090R-50 07.RS62090R-51 07.RS62090R-52 '02-07
				Front Caliper Rebuild Kit 37.63047 '03-05	07.RS62090R-48 07.RS62090R-49 07.RS62090R-50 07.RS62090R-51 07.RS62090R-52 '02-07
				Rear Master Cylinder Rebuild Kit 37.910029 '03-04	07.RS62090R-48 07.RS62090R-49 07.RS62090R-50 07.RS62090R-51 07.RS62090R-52 '02-07
					Sprocket Bolt Set 07.SBSM825 '02-07
Air Filter 52.61097 '98-07	Spring Kit 17.CS66044 '02-07	Friction Set 16.S56016 '98-07	Steering Bearing 24.110026 '98-07	Front Pad Set 37.102202 '98-07	Front Sprocket 07.FS66088-14 07.FS66088-15 07.FS66088-16 '98-07
	Master Cylinder Rebuild Kit 16.940002 '04			37.102202BX '98-07 Box of 10	07.RC520120CG '98-07 MX 07.RC520120XC '98-07 MX Gold 07.RC520120XC '98-07 X-Ring 07.RC520120XCG '98-07 X-Ring Gold
	Slave Cylinder Rebuild Kit 16.950011 '03-05			Rear Pad Set 37.204202 '98-07	7075-T6 Alloy Rear Sprocket 07.RA62090-48 07.RA62090-49 07.RA62090-50 07.RA62090-51 07.RA62090-52 '98-07
				37.204202BX '98-07 Box of 10	07.RA62090-48 07.RA62090-49 07.RA62090-50 07.RA62090-51 07.RA62090-52 '98-07
				Front Caliper Rebuild Kit 37.63047 '98-02	07.RA62090-48 07.RA62090-49 07.RA62090-50 07.RA62090-51 07.RA62090-52 '98-07
					Ultralight Steel Rear Sprocket 07.RS62090R-48 07.RS62090R-49 07.RS62090R-50 07.RS62090R-51 07.RS62090R-52 '98-07
					07.RS62090R-48 07.RS62090R-49 07.RS62090R-50 07.RS62090R-51 07.RS62090R-52 '98-07
					Sprocket Bolt Set 07.SBSM825 '98-07



**KTM**

**DIRT**  
APRILIA  
BETA  
BMW  
GAS GAS  
HONDA  
HUSABERG  
HUSQVARNA  
KAWASAKI  
KTM  
MOTO TM  
RIEJU  
SHERCO  
SUZUKI  
YAMAHA

KTM 690 Enduro 4-Stroke Please Note: Nikasil Piston Size -Std. Compression 11.8:1 -Forged Piston	<b>Piston Kit</b> 01.6608.A 01.6608.B 01.6608.C '08-10	<b>Sizes (mm)</b> 101.94 101.95 101.96	<b>Ring Set</b> 02.6608 02.6608 02.6608 '08-10  <b>Pin</b> 04.2050.9 '08-10  <b>Clips</b> 05.2012 '08-10				<b>Valve Shim Assortment</b> 29.VSA1000 '08-10 29.VSA1000-2 '08-10	<b>Valve Seal</b> 35.VS026 '08-10 2x Intake 35.VS026 '08-10 2x Exhaust
---	--	---	--	--	--	--	--	--

**STREET**  
APRILIA  
CAGIVA  
HONDA  
KAWASAKI  
KTM  
SUZUKI  
YAMAHA

KTM 690 Enduro R 4-Stroke Please Note: Nikasil Piston Size -Std. Compression 11.8:1 -Forged Piston	<b>Piston Kit</b> 01.6608.A 01.6608.B 01.6608.C '09-11	<b>Sizes</b> 101.94 101.95 101.96	<b>Ring Set</b> 02.6608 02.6608 02.6608 '09-11  <b>Pin</b> 04.2050.9 '09-11  <b>Clips</b> 05.2012 '09-11				<b>Valve Shim Assortment</b> 29.VSA1000 '09-11 29.VSA1000-2 '09-11	<b>Valve Seal</b> 35.VS026 '09-11 2x Intake 35.VS026 '09-11 2x Exhaust
---	--	--	--	--	--	--	--	--

**ATV-UTV**  
CAN-AM  
GAS GAS  
HONDA  
KAWASAKI  
KTM  
POLARIS  
SUZUKI  
YAMAHA

KTM 690 Supermoto 4-Stroke Please Note: Nikasil Piston Size -Std. Compression 11.8:1 -Forged Piston	<b>Piston Kit</b> 01.6608.A 01.6608.B 01.6608.C '07-09	<b>Sizes</b> 101.94 101.95 101.96	<b>Ring Set</b> 02.6608 02.6608 02.6608 '07-09  <b>Pin</b> 04.2050.9 '07-09  <b>Clips</b> 05.2012 '07-09				<b>Valve Shim Assortment</b> 29.VSA1000 '07-09 29.VSA1000-2 '07-09	<b>Valve Seal</b> 35.VS026 '07-09 2x Intake 35.VS026 '07-09 2x Exhaust
--	--	--	--	--	--	--	--	--

**PWC**  
KAWASAKI  
POLARIS  
SEA DOO  
YAMAHA

**SNOW**  
ARCTIC CAT  
KAWASAKI  
LYNX  
MOTO-SKI  
POLARIS  
SKI DOO  
YAMAHA

**MOPED & SCOOTER**

**MISC. TECH. SPECIAL**

Footnotes: \* Bearings Only \*\* Rubbers included

<b>Oil Filter #1</b> 54.63655 '08-10 1-Pce. 54.63655-50 '08-10 50-Pcs.		<b>F/W Bearing</b> 23.S114002 '08-10  <b>Steering Bearing</b> 24.110026 '08-10	<b>Rear Pad Set</b> 37.204202 '08-10 37.204202BX '08-10 Box of 10	<b>Front Sprocket</b> 07.FS66088-14 07.FS66088-15 07.FS66088-16 '08-10  <b>7075-T6 Alloy Rear Sprocket</b> 07.RA62090-48 07.RA62090-49 07.RA62090-50 07.RA62090-51 07.RA62090-52 '08-10  <b>Ultralight Steel Rear Sprocket</b> 07.RS62090R-48 07.RS62090R-49 07.RS62090R-50 07.RS62090R-51 07.RS62090R-52 '08-10  <b>Sprocket Bolt Set</b> 07.SBSM825 '08-10	<b>Chain</b> 07.RC520120C '08-10 MX 07.RC520120CG '08-10 MX Gold 07.RC520120XC '08-10 X-Ring 07.RC520120XCG '08-10 X-Ring Gold	<b>Seal &amp; Wiper</b> 40.S4857.89 '08-10  <b>Oil Seal Set</b> 40.F4857.89 '08-10  <b>Dust Seal Set</b> 40.F4858.8D '08-10
--	--	--	---	--	--	---

**DIRT**  
APRILIA  
BETA  
BMW  
GAS GAS  
HONDA  
HUSABERG  
HUSQVARNA  
KAWASAKI  
KTM  
MOTO TM  
RIEJU  
SHERCO  
SUZUKI  
YAMAHA

<b>Oil Filter #1</b> 54.63655 '09-11 1-Pce. 54.63655-50 '09-11 50-Pcs.	<b>Master Cylinder Rebuild Kit</b> 16.940002 '09-12 16.940028 '13-15 16.940028 '17-21	<b>F/W Bearing</b> 23.S114002 '09-11  <b>Steering Bearing</b> 24.110026 '09-15	<b>Rear Pad Set</b> 37.204202 '09-12 37.204202BX '09-12 Box of 10	<b>Front Sprocket</b> 07.FS66088-14 07.FS66088-15 07.FS66088-16 '09-12  <b>7075-T6 Alloy Rear Sprocket</b> 07.RA62090-48 07.RA62090-49 07.RA62090-50 07.RA62090-51 07.RA62090-52 '09-11  <b>Ultralight Steel Rear Sprocket</b> 07.RS62090R-48 07.RS62090R-49 07.RS62090R-50 07.RS62090R-51 07.RS62090R-52 '09-11  <b>Sprocket Bolt Set</b> 07.SBSM825 '09-11	<b>Chain</b> 07.RC520120C '09-11 MX 07.RC520120CG '09-11 MX Gold 07.RC520120XC '09-11 X-Ring 07.RC520120XCG '09-11 X-Ring Gold	<b>Seal &amp; Wiper</b> 40.S4857.89 '09-11  <b>Oil Seal Set</b> 40.F4857.89 '09-11  <b>Dust Seal Set</b> 40.F4858.8D '09-11  <b>Bushing Set</b> 39.160074 '09-10
--	---	--	---	--	--	--

**STREET**  
APRILIA  
CAGIVA  
HONDA  
KAWASAKI  
KTM  
SUZUKI  
YAMAHA

<b>Oil Filter #1</b> 54.63655 '07-09 1-Pce. 54.63655-50 '07-09 50-Pcs.		<b>F/W Bearing</b> 23.S114002 '07-09  <b>Steering Bearing</b> 24.110026 '07-09	<b>Rear Pad Set</b> 37.204202 '07-09 37.204202BX '07-09 Box of 10	<b>Front Sprocket</b> 07.FS66088-14 07.FS66088-15 07.FS66088-16 '07-09  <b>7075-T6 Alloy Rear Sprocket</b> 07.RA62090-48 07.RA62090-49 07.RA62090-50 07.RA62090-51 07.RA62090-52 '07-09  <b>Ultralight Steel Rear Sprocket</b> 07.RS62090R-48 07.RS62090R-49 07.RS62090R-50 07.RS62090R-51 07.RS62090R-52 '07-09  <b>Sprocket Bolt Set</b> 07.SBSM825 '07-09	<b>Chain</b> 07.RC520120C '07-09 MX 07.RC520120CG '07-09 MX Gold 07.RC520120XC '07-09 X-Ring 07.RC520120XCG '07-09 X-Ring Gold	<b>Seal &amp; Wiper</b> 40.S4857.89 '07-09  <b>Oil Seal Set</b> 40.F4857.89 '07-09  <b>Dust Seal Set</b> 40.F4858.8D '07-09
--	--	--	---	--	--	---

**ATV-UTV**  
CAN-AM  
GAS GAS  
HONDA  
KAWASAKI  
KTM  
POLARIS  
SUZUKI  
YAMAHA

**PWC**  
KAWASAKI  
POLARIS  
SEA DOO  
YAMAHA

**SNOW**  
ARCTIC CAT  
KAWASAKI  
LYNX  
MOTO-SKI  
POLARIS  
SKI DOO  
YAMAHA

**MOPED & SCOOTER**

**MISC. TECH. SPECIAL**

**KTM**

**DIRT**  
APRILIA  
BETA  
BMW  
GAS GAS  
HONDA  
HUSABERG  
HUSQVARNA  
KAWASAKI  
KTM  
MOTO TM  
RIEJU  
SHERCO  
SUZUKI  
YAMAHA

**STREET**  
APRILIA  
CAGIVA  
HONDA  
KAWASAKI  
KTM  
SUZUKI  
YAMAHA

**ATV-UTV**  
CAN-AM  
GAS GAS  
HONDA  
KAWASAKI  
KTM  
POLARIS  
SUZUKI  
YAMAHA

**PWC**  
KAWASAKI  
POLARIS  
SEA DOO  
YAMAHA

**SNOW**  
ARCTIC CAT  
KAWASAKI  
LYNX  
MOTO-SKI  
POLARIS  
SKI DOO  
YAMAHA

**MOPED & SCOOTER**

**MISC. TECH. SPECIAL**

KTM 690 SMC 4-Stroke Please Note: Nikasil Piston Size -Std. Compression 11.8:1 -Forged Piston	<b>Piston Kit</b> 01.6608.A 01.6608.B 01.6608.C '08-11	<b>Size</b> 101.94 101.95 101.96	<b>Ring Set</b> 02.6608 02.6608 02.6608 '08-11				<b>Valve Shim Assortment</b> 29.VSA1000 '08-11 29.VSA1000-2 '08-11	<b>Valve Seal</b> 35.VS026 '08-11 2x Intake 35.VS026 '08-11 2x Exhaust
			<b>Pin</b> 04.2050.9 '08-11					
				<b>Clips</b> 05.2012 '08-11				
KTM 990 Supermoto 4-Stroke Twin Cylinder Please Note: Nikasil Piston Size -Std. Compression 11.5:1 -Forged Piston	<b>Piston Kit</b> -	<b>Size</b> 101.00	<b>Ring Set</b> -				<b>Valve Shim Assortment</b> 29.VSA1000 '08-13 29.VSA1000-2 '08-13	<b>Valve Seal</b> 35.VS026 '08-13 4x Intake 35.VS026 '08-13 4x Exhaust
KTM 990 Supermoto R 4-Stroke Twin Cylinder Please Note: Nikasil Piston Size -Std. Compression 11.5:1 -Forged Piston	<b>Piston Kit</b> -	<b>Size</b> 101.00	<b>Ring Set</b> -				<b>Valve Shim Assortment</b> 29.VSA1000 '09-13 29.VSA1000-2 '09-13	<b>Valve Seal</b> 35.VS026 '09-13 4x Intake 35.VS026 '09-13 4x Exhaust

Footnotes: \* Bearings Only \*\* Rubbers included

<b>Oil Filter #1</b> 54.63655 '08-11 1-Pce. 54.63655-50 '08-11 50-Pcs.	<b>Master Cylinder Rebuild Kit</b> 16.940002 '08-10		<b>F/W Bearing</b> 23.S114002 '08-11	<b>Rear Pad Set</b> 37.204202 '08-11 37.204202BX '08-11 Box of 10	<b>Front Sprocket</b> 07.FS66088-14 07.FS66088-15 07.FS66088-16 '08-11	<b>Chain</b> 07.RC520120C '08-11 MX 07.RC520120CG '08-11 MX Gold 07.RC520120XC '08-11 X-Ring 07.RC520120XCG '08-11 X-Ring Gold	<b>Seal &amp; Wiper</b> 40.S4857.89 '08-11
<b>Oil Filter #2</b> 54.64157 '08-11 1-Pce. 54.64157-50 '08-11 50-Pcs.	<b>Slave Cylinder Rebuild Kit</b> 16.950009 '08-10		<b>Steering Bearing</b> 24.110026 '08-11		<b>7075-T6 Alloy Rear Sprocket</b> 07.RA62090-48 07.RA62090-49 07.RA62090-50 07.RA62090-51 07.RA62090-52 '08-11		<b>Oil Seal Set</b> 40.F4857.89 '08-11
					<b>Ultralight Steel Rear Sprocket</b> 07.RS62090R-48 07.RS62090R-49 07.RS62090R-50 07.RS62090R-51 07.RS62090R-52 '08-11		<b>Dust Seal Set</b> 40.F4857.8D '08-11
	<b>Master Cylinder Rebuild Kit</b> 16.940002 '10-11		<b>F/W Bearing</b> 23.S114002 '08-13	<b>Rear Pad Set</b> 37.102202 '08-13 37.102202BX '08-13 Box of 10			<b>Seal &amp; Wiper</b> 40.S4857.89 '08-13
			<b>Steering Bearing</b> 24.110026 '08-13				<b>Oil Seal Set</b> 40.F4857.89 '08-13
			<b>F/W Bearing</b> 23.S114002 '09-13	<b>Rear Pad Set</b> 37.102202 '09-13 37.102202BX '09-13 Box of 10			<b>Dust Seal Set</b> 40.F4858.8D '08-13
			<b>Steering Bearing</b> 24.110026 '09-13				<b>Oil Seal Set</b> 40.F4857.89 '09-13
							<b>Dust Seal Set</b> 40.F4858.8D '09-13

**DIRT**  
APRILIA  
BETA  
BMW  
GAS GAS  
HONDA  
HUSABERG  
HUSQVARNA  
KAWASAKI  
KTM  
MOTO TM  
RIEJU  
SHERCO  
SUZUKI  
YAMAHA

**STREET**  
APRILIA  
CAGIVA  
HONDA  
KAWASAKI  
KTM  
SUZUKI  
YAMAHA

**ATV-UTV**  
CAN-AM  
GAS GAS  
HONDA  
KAWASAKI  
KTM  
POLARIS  
SUZUKI  
YAMAHA

**PWC**  
KAWASAKI  
POLARIS  
SEA DOO  
YAMAHA

**SNOW**  
ARCTIC CAT  
KAWASAKI  
LYNX  
MOTO-SKI  
POLARIS  
SKI DOO  
YAMAHA

**MOPED & SCOOTER**

**MISC. TECH. SPECIAL**



**MOTO TM**

DIRT	Piston Kit	Size	Ring Set	Bearing	S/E Bearing
<b>DIRT</b> MX 85 2-Stroke Please Note: Nikasil Piston Size -Forged Piston		47.94			
<b>STREET</b> MX 125 EN 125 2-Stroke Please Note: Nikasil Piston Size -Forged Piston	<b>Piston Kit</b> 01.7223.A 01.7223.B 01.7223.C '92-19	<b>Size</b> 53.94 53.95 53.96	<b>Ring Set</b> 02.6221 02.6221 02.6221 '92-19  <b>Pin</b> 04.1545 '92-19  <b>Clips</b> 05.1510 '92-19	<b>Bearing</b> 23.6322C4 '99-12 Left 23.NJ206 '13-19 Left 23.6205C4 '99-12 Right 23.6305C3 '13-14 Right	<b>S/E Bearing</b> 21.2221 '92-23
<b>ATV-UTV</b> MX 144 EN 144 2-Stroke Please Note: Nikasil Piston Size	<b>Piston Kit</b> 01.7207.A 01.7207.B 01.7207.C '08-19	<b>Size</b> 55.94 55.95 55.96	<b>Ring Set</b> 02.7207 02.7207 02.7207 '08-19  <b>Clips</b> 05.1510 '08-19	<b>Bearing</b> 23.6322C4 '08-12 Left 23.NJ206 '13-22 Left 23.6205C4 '08-12 Right 23.6305C3 '13-14 Right	<b>S/E Bearing</b> 21.2221 '08-23
<b>PWC</b> MX 144 EN 144 2-Stroke Please Note: Nikasil Piston Size	<b>Piston Kit</b> 01.7207.A 01.7207.B 01.7207.C '08-19	<b>Size</b> 55.94 55.95 55.96	<b>Ring Set</b> 02.7207 02.7207 02.7207 '08-19  <b>Clips</b> 05.1510 '08-19	<b>Bearing</b> 23.6322C4 '08-12 Left 23.NJ206 '13-22 Left 23.6205C4 '08-12 Right 23.6305C3 '13-14 Right	<b>S/E Bearing</b> 21.2221 '08-23
<b>SNOW</b> MX 144 EN 144 2-Stroke Please Note: Nikasil Piston Size	<b>Piston Kit</b> 01.7207.A 01.7207.B 01.7207.C '08-19	<b>Size</b> 55.94 55.95 55.96	<b>Ring Set</b> 02.7207 02.7207 02.7207 '08-19  <b>Clips</b> 05.1510 '08-19	<b>Bearing</b> 23.6322C4 '08-12 Left 23.NJ206 '13-22 Left 23.6205C4 '08-12 Right 23.6305C3 '13-14 Right	<b>S/E Bearing</b> 21.2221 '08-23
<b>MOPED &amp; SCOOTER</b> MX 144 EN 144 2-Stroke Please Note: Nikasil Piston Size	<b>Piston Kit</b> 01.7207.A 01.7207.B 01.7207.C '08-19	<b>Size</b> 55.94 55.95 55.96	<b>Ring Set</b> 02.7207 02.7207 02.7207 '08-19  <b>Clips</b> 05.1510 '08-19	<b>Bearing</b> 23.6322C4 '08-12 Left 23.NJ206 '13-22 Left 23.6205C4 '08-12 Right 23.6305C3 '13-14 Right	<b>S/E Bearing</b> 21.2221 '08-23
<b>MISC. TECH. SPECIAL</b> MX 144 EN 144 2-Stroke Please Note: Nikasil Piston Size	<b>Piston Kit</b> 01.7207.A 01.7207.B 01.7207.C '08-19	<b>Size</b> 55.94 55.95 55.96	<b>Ring Set</b> 02.7207 02.7207 02.7207 '08-19  <b>Clips</b> 05.1510 '08-19	<b>Bearing</b> 23.6322C4 '08-12 Left 23.NJ206 '13-22 Left 23.6205C4 '08-12 Right 23.6305C3 '13-14 Right	<b>S/E Bearing</b> 21.2221 '08-23

Footnotes: \* Bearings Only \*\* Rubbers included

Air Filter	F/W Bearing	Front Pad Set	Front Sprocket	Chain	Swingarm
<b>Air Filter</b> 52.74013 '13-23	<b>F/W Bearing</b> 23.S111035 '06-09  <b>Steering Bearing</b> 24.110022 '06-09	<b>Front Pad Set</b> 37.208202 '13-23 37.208202BX '13-23 Box of 10  <b>Rear Pad Set</b> 37.208202 '13-23 37.208202BX '13-23 Box of 10	<b>Front Sprocket</b> 07.FS61090-15 07.FS61090-16 07.FS61090-17 '90-23	<b>Chain</b> 07.RC428130C '90-23 MX	
<b>Air Filter</b> 52.72095 '95-07 52.72008 '08-12 52.73013 '96-04 52.73015 '15-23	<b>F/W Bearing</b> 23.S250001 '07-23  <b>R/W Bearing</b> 23.S115050 '96-04 23.S115048 '05-11 23.S250002 '15-23  <b>Steering Bearing</b> 24.110022 '96-97 24.110003 '98-01 24.110010 '02-23	<b>Frontbrake Disc</b> 37.BD17090 '10-23  <b>Rearbrake Disc</b> 37.BD27004 '05-23  <b>Front Pad Set</b> 37.102202 '95-23 37.102202BX '95-23 Box of 10  <b>Rear Pad Set</b> 37.204202 '95-00 37.204202BX '95-00 Box of 10 37.207102 '01-04 37.207102BX '01-04 Box of 10 37.201302 '05-23 37.201302BX '05-23 Box of 10	<b>Front Sprocket</b> 07.FS62001-12 07.FS62001-13 '01-23  <b>7075-T6 Alloy Rear Sprocket</b> 07.RA73097-49 07.RA73097-50 07.RA73097-51 07.RA73097-52 '97-23  <b>Sprocket Bolt Set</b> 07.SBSM825 '92-23	<b>Chain</b> 07.RC520120C '92-23 MX 07.RC520120CG '92-23 X-Ring 07.RC520120XC '92-23 X-Ring Gold  <b>Lower Chain Roller</b> 33.0001 '96-07  <b>Upper Chain Roller</b> 33.0001 '96-07	<b>Linkage</b> 26.210183 '96-07  <b>Lower</b> 26.110155 '96-04 26.110156 '05-06 26.110163 '07-23  <b>Lower</b> 26.450057 '96-04 26.450058 '05-06 26.450061 '07-23
<b>Air Filter</b> 52.72008 '08-12 52.73013 '13-14 Kickstarter 52.73015 '15-21	<b>F/W Bearing</b> 23.S250001 '07-23  <b>R/W Bearing</b> 23.S115048 '08-11 23.S250002 '15-23  <b>Steering Bearing</b> 24.110010 '08-23	<b>Frontbrake Disc</b> 37.BD17090 '10-23  <b>Rearbrake Disc</b> 37.BD27004 '08-23  <b>Front Pad Set</b> 37.102202 '08-23 37.102202BX '08-23 Box of 10  <b>Rear Pad Set</b> 37.201302 '08-23 37.201302BX '08-23 Box of 10	<b>Front Sprocket</b> 07.FS62001-12 07.FS62001-13 '08-23  <b>7075-T6 Alloy Rear Sprocket</b> 07.RA73097-49 07.RA73097-50 07.RA73097-51 07.RA73097-52 '08-23  <b>Sprocket Bolt Set</b> 07.SBSM825 '08-23	<b>Chain</b> 07.RC520120C '08-23 MX 07.RC520120CG '08-23 MX Gold 07.RC520120XC '08-23 X-Ring 07.RC520120XCG '08-23 X-Ring Gold	<b>Linkage</b> 26.110163 '08-23  <b>Lower</b> 26.450061 '08-23

DIRT	STREET	ATV-UTV	PWC	SNOW	MOPED & SCOOTER	MISC. TECH. SPECIAL
<b>DIRT</b> APRILIA BETA BMW GAS GAS HONDA HUSABERG HUSQVARNA KAWASAKI KTM <b>MOTO TM</b> RIEJU SHERCO SUZUKI YAMAHA	<b>STREET</b> APRILIA CAGIVA HONDA KAWASAKI KTM SUZUKI YAMAHA	<b>ATV-UTV</b> CAN-AM GAS GAS HONDA KAWASAKI KTM POLARIS SUZUKI YAMAHA	<b>PWC</b> KAWASAKI POLARIS SEA DOO YAMAHA	<b>SNOW</b> ARCTIC CAT KAWASAKI LYNX MOTO-SKI POLARIS SKI DOO YAMAHA	<b>MOPED &amp; SCOOTER</b> MX 144 EN 144 2-Stroke Please Note: Nikasil Piston Size	<b>MISC. TECH. SPECIAL</b> MX 144 EN 144 2-Stroke Please Note: Nikasil Piston Size

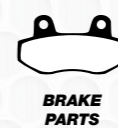

### MOTO TM

DIRT	APRILIA	BETA	BMW	GAS GAS	HONDA	HUSABERG	HUSQVARNA	KAWASAKI	KTM	MOTO TM	RIEJU	SHERCO	SUZUKI	YAMAHA
MX 250 EN 250 2-Stroke Please Note: Nikasil Piston Size -Forged Piston -Dual Ring Design	<b>Piston Kit</b> 01.7309.A 01.7309.B 01.7309.C '99-23	<b>Size</b> 66.34 66.35 66.36	<b>Ring Set</b> 02.7307 02.7307 02.7307 '99-23	<b>Bearing</b> 23.6328C4 '01-14 2x 23.NJ206 '15-19 2x	<b>S/E Bearing</b> 21.1316 '99-23									
			<b>Pin</b> 04.1853.4 '99-23											
			<b>Clips</b> 05.1812 '99-23											
MX 250 F EN 250 F 4-Stroke Please Note: Nikasil Piston Size -Forged Piston	<b>Piston Kit</b> 01.6307.A 01.6307.B 01.6307.C '07-10	<b>Size</b> 76.96 76.97 76.98	<b>Ring Set</b> 02.6307 02.6307 02.6307 '07-10	<b>Bearing</b> 23.6206C3 '01-10 2x				<b>CAMChain</b> 31.6301 '01-06 31.6307 '07-10						
			<b>Clips</b> 05.1612C '07-10											
MX 250 Fi EN 250 Fi 4-Stroke Please Note: Nikasil Piston Size -Forged Piston -Fuel Injection	<b>Piston Kit</b> 01.6311.A 01.6311.B 01.6311.C '11-12	<b>Size</b> 76.95 76.96 76.97	<b>Ring Set</b> 02.3340 02.3340 02.3340 '11-12	<b>Bearing</b> 23.NJ206 '10-15 Right				<b>CAMChain</b> 31.1993 '10-12						
			<b>Clips</b> 05.1612C '10-12											

Footnotes: \* Bearings Only \*\* Rubbers included

AIR & FUEL PARTS	CLUTCH PARTS	CLUTCH PLATE SETS	WHEEL & STEERING PARTS	BRAKE PARTS	DRIVE CHAIN PARTS I	DRIVE CHAIN PARTS II	SUSPENSION BEARING KITS	SUSPENSION PARTS
<b>Air Filter</b> 52.72095 '95-07 52.72008 '08-12 52.73013 13-14 Kickstarter 52.73015 '15-18			<b>F/W Bearing</b> 23.S250001 '07-23	<b>Frontbrake Disc</b> 37.BD17090 '10-23	<b>Front Sprocket</b> 07.FS63094-13 '94-23	<b>Chain</b> 07.RC520120C '94-23 MX 07.RC520120CG '94-23 MX Gold 07.RC520120XC '94-23 X-Ring 07.RC520120XCG '94-23 X-Ring Gold	<b>Swingarm</b> 26.210183 '96-06	
			<b>R/W Bearing</b> 23.S115050 '96-04 23.S115048 '05-11 23.S250002 '15-23	<b>Rearbrake Disc</b> 37.BD27004 '05-23	<b>7075-T6 Alloy Rear Sprocket</b> 07.RA73097-49 07.RA73097-50 07.RA73097-51 07.RA73097-52 '97-23	<b>Linkage</b> 26.110155 '96-04 26.110156 '05-06 26.110163 '07-23		
			<b>Steering Bearing</b> 24.110022 '96-97 24.110003 '98-01 24.110010 '02-23	<b>Front Pad Set</b> 37.102202 '95-23 37.102202BX '95-23 Box of 10	<b>Sprocket Bolt Set</b> 07.SBSM825 '94-23	<b>Lower Chain Roller</b> 33.0001 '96-07	<b>Lower</b> 26.450057 '96-04 26.450058 '05-06 26.450061 '07-23	
				<b>Rear Pad Set</b> 37.204202 '95-00 37.204202BX '95-00 Box of 10 37.207102 '01-04 37.207102BX '01-04 Box of 10 37.201302 '05-23 37.201302BX '05-23 Box of 10		<b>Upper Chain Roller</b> 33.0001 '96-07		
<b>Air Filter</b> 52.72008 '01-10			<b>F/W Bearing</b> 23.S111035 '02-04 23.S115049 '05-06 23.S250001 '07-10	<b>Frontbrake Disc</b> 37.BD17090 '10	<b>Front Sprocket</b> 07.FS63094-13 07.FS64010-14 '02-10	<b>Chain</b> 07.RC520120C '02-10 MX 07.RC520120CG '02-10 MX Gold 07.RC520120XC '02-10 X-Ring 07.RC520120XCG '02-10 X-Ring Gold	<b>Swingarm</b> 26.210183 '02-07	
			<b>R/W Bearing</b> 23.S115050 '02-04 23.S115048 '05-10	<b>Rearbrake Disc</b> 37.BD27004 '05-10	<b>7075-T6 Alloy Rear Sprocket</b> 07.RA73097-49 07.RA73097-50 07.RA73097-51 07.RA73097-52 '01-10	<b>Linkage</b> 26.110155 '02-04 26.110156 '05-06 26.110163 '07-10		
			<b>Steering Bearing</b> 24.110010 '02-10	<b>Front Pad Set</b> 37.102202 '04-10 37.102202BX '04-10 Box of 10	<b>Sprocket Bolt Set</b> 07.SBSM825 '02-10	<b>Lower Chain Roller</b> 33.0001 '02-07	<b>Lower</b> 26.450057 '02-04 26.450058 '05-06 26.450061 '07-10	
				<b>Rear Pad Set</b> 37.207102 '04 37.207102BX '04 Box of 10 37.201302 '05-10 37.201302BX '05-10 Box of 10		<b>Upper Chain Roller</b> 33.0001 '02-07		
<b>Air Filter</b> 52.72008 '10-12 52.74013 '13-14 Electric 52.74015 '15-18			<b>F/W Bearing</b> 23.S250001 '10-23	<b>Frontbrake Disc</b> 37.BD17090 '10-23	<b>Front Sprocket</b> 07.FS63010-12 07.FS63010-13 '10-23	<b>Chain</b> 07.RC520120C '10-23 MX 07.RC520120CG '10-23 MX Gold 07.RC520120XC '10-23 X-Ring 07.RC520120XCG '10-23 X-Ring Gold	<b>Linkage</b> 26.110163 '10-23	
			<b>R/W Bearing</b> 23.S115048 '10-11 23.S250002 '15-23	<b>Rearbrake Disc</b> 37.BD27004 '10-23	<b>7075-T6 Alloy Rear Sprocket</b> 07.RA73097-49 07.RA73097-50 07.RA73097-51 07.RA73097-52 '10-23	<b>Lower</b> 26.450061 '10-23		
			<b>Steering Bearing</b> 24.110010 '10-23	<b>Front Pad Set</b> 37.102202 '10-23 37.102202BX '10-23 Box of 10	<b>Sprocket Bolt Set</b> 07.SBSM825 '10-23			
				<b>Rear Pad Set</b> 37.201302 '10-23 37.201302BX '10-23 Box of 10				

Footnotes: \* Bearings Only \*\* Rubbers included





### MOTO TM

DIRT	APRILIA	BETA	BMW	GAS GAS	HONDA	HUSABERG	HUSQVARNA	KAWASAKI	KTM	MOTO TM	RIEJU	SHERCO	SUZUKI	YAMAHA
MX 300 EN 300 2-Stroke Please Note: Nikasil Piston Size -Forged Piston -Dual Ring Design	<b>Piston Kit</b> 01.7302.A 01.7302.B 01.7302.C '02-23	<b>Size</b> 71.94 71.95 71.96	<b>Ring Set</b> 02.6396 02.6396 02.6396 '02-23	<b>Bearing</b> 23.6328C4 '01-14 2x 23.NJ206 '15-19 2x	<b>S/E Bearing</b> 21.1316 '99-23									
			<b>Pin</b> 04.1853.4 '02-23											
			<b>Clips</b> 05.1812 '02-23											
MX 400 F EN 400 F 4-Stroke Please Note : Nikasil Piston Size -Forged Piston	<b>Piston Kit</b> -	<b>Size</b> 92.00	<b>Ring Set</b> -					<b>CAMChain</b> 31.1661 '01-03						
MX 450 F EN 450 F 4-Stroke Please Note: Nikasil Piston Size -Forged Piston	<b>Piston Kit</b> 01.6415.A '03-08	<b>Size</b> 94.94	<b>Ring Set</b> 02.6419 '03-08	<b>Bearing</b> 23.6306C4 '05-14 2x				<b>CAMChain</b> 31.1900 '06-12						
Please Note: Nikasil Piston Size -Forged Piston	01.6419.A 01.6419.B 01.6419.C '09-10	94.94 94.95 94.96	02.6419 02.6419 02.6419 '09-10											
			<b>Pin</b> 04.1947.5 '05-11											
			<b>Clips</b> 05.1912 '05-11											

Footnotes: \* Bearings Only \*\* Rubbers included

AIR & FUEL PARTS	CLUTCH PARTS	CLUTCH PLATE SETS	WHEEL & STEERING PARTS	BRAKE PARTS	DRIVE CHAIN PARTS I	DRIVE CHAIN PARTS II	SUSPENSION BEARING KITS	SUSPENSION PARTS
<b>Air Filter</b> 52.72095 '95-07 52.72008 '08-12 52.73013 '05-11 52.73015 '15-18			<b>F/W Bearing</b> 23.S250001 '07-23	<b>Frontbrake Disc</b> 37.BD17090 '10-23	<b>Front Sprocket</b> 07.FS63094-13 '96-23	<b>Chain</b> 07.RC520120C '96-23 MX 07.RC520120CG '96-23 MX Gold 07.RC520120XC '96-23 X-Ring 07.RC520120XCG '96-23 X-Ring Gold	<b>Swingarm</b> 26.210183 '97-07	
			<b>R/W Bearing</b> 23.S115050 '97-04 23.S115048 '05-11 23.S250002 '15-23	<b>Rearbrake Disc</b> 37.BD27004 '05-23	<b>7075-T6 Alloy Rear Sprocket</b> 07.RA73097-49 07.RA73097-50 07.RA73097-51 07.RA73097-52 '97-23	<b>Linkage</b> 26.110155 '97-04 26.110156 '05-06 26.110163 '07-3		
			<b>Steering Bearing</b> 24.110022 '97 24.110003 '98-01 24.110010 '02-23	<b>Front Pad Set</b> 37.102202 '95-23 37.102202BX '95-23 Box of 10	<b>Sprocket Bolt Set</b> 07.SBSM825 '02-23	<b>Lower Chain Roller</b> 33.0001 '97-07	<b>Lower</b> 26.450057 '97-04 26.450058 '05-06 26.450061 '07-23	
				<b>Rear Pad Set</b> 37.204202 '95-00 37.204202BX '95-00 Box of 10 37.207102 '04 37.207102BX '04 Box of 10 37.201302 '05-23 37.201302BX '05-23 Box of 10		<b>Upper Chain Roller</b> 33.0001 '97-07		
<b>Air Filter</b> 52.72008 '01-03			<b>F/W Bearing</b> 23.S111035 '02-03		<b>7075-T6 Alloy Rear Sprocket</b> 07.RA73097-49 07.RA73097-50 07.RA73097-51 07.RA73097-52 '01-03	<b>Chain</b> 07.RC520120C '01-03 MX 07.RC520120CG '01-03 MX Gold 07.RC520120XC '01-03 X-Ring 07.RC520120XCG '01-03 X-Ring Gold	<b>Swingarm</b> 26.210183 '02-03	
			<b>R/W Bearing</b> 23.S115050 '02-03			<b>Linkage</b> 26.110155 '02-03		
			<b>Steering Bearing</b> 24.110010 '02-03		<b>Sprocket Bolt Set</b> 07.SBSM825 '01-03	<b>Lower Chain Roller</b> 33.0001 '02-03	<b>Lower</b> 26.450057 '02-03	
						<b>Upper Chain Roller</b> 33.0001 '02-03		
<b>Air Filter</b> 52.72008 '01-12			<b>F/W Bearing</b> 23.S111035 '04 23.S115049 '06 23.S250001 '07-18	<b>Rearbrake Disc</b> 37.BD27004 '05-18	<b>Front Sprocket</b> 07.FS63094-13 07.FS64010-14 '01-14	<b>Chain</b> 07.RC520120C '01-14 MX 07.RC520120CG '01-14 MX Gold 07.RC520120XC '01-14 X-Ring 07.RC520120XCG '01-14 X-Ring Gold	<b>Swingarm</b> 26.210183 '04-07	
			<b>R/W Bearing</b> 23.S115050 '04 23.S115048 '05-11 23.S250002 '15-18	<b>Front Pad Set</b> 37.102202 '04-18 37.102202BX '04-18 Box of 10	<b>7075-T6 Alloy Rear Sprocket</b> 07.RA73097-49 07.RA73097-50 07.RA73097-51 07.RA73097-52 '01-14	<b>Linkage</b> 26.110155 '04 26.110156 '05-06 26.110163 '07-11		
			<b>Steering Bearing</b> 24.110010 '04-11	<b>Rear Pad Set</b> 37.207102 '04 37.207102BX '04 Box of 10 37.201302 '05-18 37.201302BX '05-18 Box of 10	<b>Sprocket Bolt Set</b> 07.SBSM825 '01-14	<b>Lower Chain Roller</b> 33.0001 '04-07	<b>Lower</b> 26.450057 '04 26.450058 '05-06 26.450061 '07-11	

Footnotes: \* Bearings Only \*\* Rubbers included

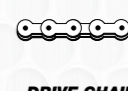

### MOTO TM

**DIRT**  
APRILIA  
BETA  
BMW  
GAS GAS  
HONDA  
HUSABERG  
HUSQVARNA  
KAWASAKI  
KTM  
MOTO TM  
RIEJU  
SHERCO  
SUZUKI  
YAMAHA

MX 450 Fi EN 450 Fi 4-Stroke Please Note: -Nikasil Piston Size -Forged Piston -Fuel Injection from 2011	<b>Piston Kit</b> 01.6419.A 01.6419.B 01.6419.C '11	<b>Size</b> 94.94 94.95 94.96	<b>Ring Set</b> 02.6419 02.6419 02.6419 '11	<b>Bearing</b> 23.6306C4 '11-14 2x			<b>CAMChain</b> 31.1900 '11-12	
			<b>Pin</b> 04.1947.5 '11					
			<b>Clips</b> 05.1912 '11					

**STREET**  
APRILIA  
CAGIVA  
HONDA  
KAWASAKI  
KTM  
SUZUKI  
YAMAHA

MX 530 F EN 530 F 4-Stroke Please Note: -Nikasil Piston Size -Forged Piston	<b>Piston Kit</b> -	<b>Size</b> 98.00	<b>Ring Set</b> -	<b>Bearing</b> 23.6306C4 '03-13 2x			<b>CAMChain</b> 31.6502 '02-06 31.1997 '07-13	
--	------------------------	----------------------	----------------------	--	--	--	---	--

**ATV-UTV**  
CAN-AM  
GAS GAS  
HONDA  
KAWASAKI  
KTM  
POLARIS  
SUZUKI  
YAMAHA

### RIEJU

**PWC**  
KAWASAKI  
POLARIS  
SEA DOO  
YAMAHA

MR 300 PRO / RACING / RANGER 2-Stroke Please Note: -Nikasil Piston Size -Forged Piston -Gas Engine	<b>Piston Kit</b> 01.7300.A 01.7300.B 01.7300.C '21-23	<b>Size</b> 71.94 71.95 71.96	<b>Ring Set</b> 02.6396 02.6396 02.6396 '21-23		<b>Con. Rod Kit</b> 03.1315 '21-23			<b>S/E Bearing</b> 21-23.1303 '21-23
			<b>Pin</b> 04.1853.4 '21-23					
			<b>Clips</b> 05.1812 '21-23					

**SNOW**  
ARCTIC CAT  
KAWASAKI  
LYNX  
MOTO-SKI  
POLARIS  
SKI DOO  
YAMAHA

**MOPED & SCOOTER**

**MISC. TECH. SPECIAL**

Footnotes: \* Bearings Only \*\* Rubbers included

**DIRT**  
APRILIA  
BETA  
BMW  
GAS GAS  
HONDA  
HUSABERG  
HUSQVARNA  
KAWASAKI  
KTM  
MOTO TM  
RIEJU  
SHERCO  
SUZUKI  
YAMAHA

**STREET**  
APRILIA  
CAGIVA  
HONDA  
KAWASAKI  
KTM  
SUZUKI  
YAMAHA

**ATV-UTV**  
CAN-AM  
GAS GAS  
HONDA  
KAWASAKI  
KTM  
POLARIS  
SUZUKI  
YAMAHA

**PWC**  
KAWASAKI  
POLARIS  
SEA DOO  
YAMAHA

**SNOW**  
ARCTIC CAT  
KAWASAKI  
LYNX  
MOTO-SKI  
POLARIS  
SKI DOO  
YAMAHA

**MOPED & SCOOTER**

**MISC. TECH. SPECIAL**

<b>Air Filter</b> 52.72008 '11-12 52.74013 '13-14 Electric 52.74015 '15-18		<b>F/W Bearing</b> 23.S250001 '11-23	<b>Frontbrake Disc</b> 37.BD17090 '11-23	<b>Front Sprocket</b> 07.FS63094-13 07.FS64010-14 '11-23	<b>Chain</b> 07.RC520120C '11-23 MX 07.RC520120CG '11-23 MX Gold 07.RC520120XC '11-23 X-Ring 07.RC520120XCG '11-23 X-Ring Gold	<b>Linkage</b> 26.110163 '11-23		
		<b>R/W Bearing</b> 23.S115048 '11 23.S250002 '15-23	<b>Rearbrake Disc</b> 37.BD27004 '11-23	<b>7075-T6 Alloy Rear Sprocket</b> 07.RA73097-49 07.RA73097-50 07.RA73097-51 07.RA73097-52 '11-23		<b>Lower</b> 26.450061 '11-23		
		<b>Steering Bearing</b> 24.110010 '11-23	<b>Front Pad Set</b> 37.102202 '11-23	<b>Sprocket Bolt Set</b> 07.SBSM825 '11-23				
			<b>Rear Pad Set</b> 37.201302 '11-23 37.201302Bx '11-23 Box of 10					

<b>Air Filter</b> 52.72008 '01-12		<b>F/W Bearing</b> 23.S111035 '02-04 23.S115049 '06 23.S250001 '07-18	<b>Frontbrake Disc</b> 37.BD17090 '10-18	<b>Front Sprocket</b> 07.FS63094-13 07.FS64010-14 '03-18	<b>Chain</b> 07.RC520120C '03-18 MX 07.RC520120CG '03-18 MX Gold 07.RC520120XC '03-18 X-Ring 07.RC520120XCG '03-18 X-Ring Gold	<b>Swingarm</b> 26.210183 '02-07		
		<b>R/W Bearing</b> 23.S115050 '02-04 23.S115048 '05-11 23.S250002 '15-18	<b>Rearbrake Disc</b> 37.BD27004 '05-18	<b>7075-T6 Alloy Rear Sprocket</b> 07.RA73097-49 07.RA73097-50 07.RA73097-51 07.RA73097-52 '03-18		<b>Linkage</b> 26.110155 '02-04 26.110156 '05-06 26.110163 '07-18		
		<b>Steering Bearing</b> 24.110010 '02-18	<b>Front Pad Set</b> 37.102202 '04-18 37.102202BX '04-18 Box of 10	<b>Sprocket Bolt Set</b> 07.SBSM825 '03-18		<b>Lower</b> 26.450057 '02-04 26.450058 '05-06 26.450061 '07-18		
			<b>Rear Pad Set</b> 37.207102 '04 37.207102BX '04 Box of 10 37.201302 '05-18 37.201302BX '05-18 Box of 10					

<b>Air Filter</b> 52.73018 '21-23	<b>Master Cylinder Rebuild Kit</b> 16.940003 '21-23	<b>F/W Bearing</b> 23.S113064 '21-23	<b>Frontbrake Disc</b> 37.BD17095 '21-23	<b>Front Sprocket</b> 07.FS73000-12 07.FS73000-13 '21-23	<b>Chain</b> 07.RC520120C '21-23 MX 07.RC520120CG '21-23 MX Gold 07.RC520120XC '21-23 X-Ring 07.RC520120XCG '21-23 X-Ring Gold	<b>Seal &amp; Wiper</b> 40.S485810 '21-23		
<b>Main Jet</b> 45.100-225 '21-23 Keihin		<b>R/W Bearing</b> 23.S114058 '21-23	<b>Rearbrake Disc</b> 37.BD27095 '21-23	<b>7075-T6 Alloy Rear Sprocket</b> 07.RA62097-46 07.RA62097-47 07.RA62097-48 07.RA62097-49 07.RA62097-50 07.RA62097-51 07.RA62097-52 '21-23		<b>Oil Seal Set</b> 40.F485810 '21-23		
<b>Pilot Jet</b> 46.040-085 '21-23 Keihin		<b>Steering Bearing</b> 24.110056 '21-23	<b>Front Pad Set</b> 37.103202 '21-23 37.103202BX '21-23 Box of 10	<b>UltraLight Steel Rear Sprocket</b> 07.RS62097-46 07.RS62097-47 07.RS62097-48 07.RS62097-49 07.RS62097-50 07.RS62097-51 07.RS62097-52 '21-23		<b>Dust Seal Set</b> 40.F4858D '21-23		
			<b>Rear Pad Set</b> 37.201302 '21-23 37.201302BX '21-23 Box of 10	<b>Sprocket Bolt Set</b> 07.SBSM825 '21-23				

**PWC**  
KAWASAKI  
POLARIS  
SEA DOO  
YAMAHA

**SNOW**  
ARCTIC CAT  
KAWASAKI  
LYNX  
MOTO-SKI  
POLARIS  
SKI DOO  
YAMAHA

**MOPED & SCOOTER**

**MISC. TECH. SPECIAL**

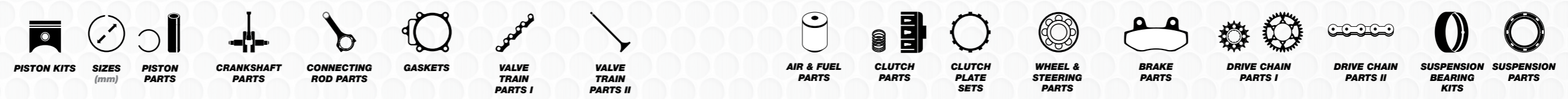

### SHERCO

**DIRT**  
APRILIA  
BETA  
BMW  
GAS GAS  
HONDA  
HUSABERG  
HUSQVARNA  
KAWASAKI  
KTM  
MOTO TM  
RIEJU  
SHERCO  
SUZUKI  
YAMAHA

SE / SM 50 2-Stroke	Piston Kit 01.1010.130 01.1010.150 01.1010.175 01.1010.200 '03-22	Size 40.30 40.50 40.75 41.00	Ring Set 02.1010.125 02.1010.150 02.1010.175 02.1010.200 '03-22  Clips 05.1210C '03-22	Bearing 23.6303C3 '03-22 2x	S/E Bearing 21.7012 '03-22				
125 SE-R 2-Stroke Please Note: Nikasil Piston Size	Piston Kit 01.7228.A 01.7228.B 01.7228.C '18-23	Size 53.95 53.96 53.97	Ring Set 02.4251 02.4251 02.4251 '18-23  Clips 05.1510 '18-23	Bearing 23.NJ206ECP-1 '18-23 2x	S/E Bearing 21.1211 '18-23				
125 SC-R 2-Stroke Please Note: Nikasil Piston Size	Piston Kit 01.7228.A 01.7228.B 01.7228.C '19	Size 53.95 53.96 53.97	Ring Set 02.4251 02.4251 02.4251 '19  Clips 05.1510 '19	Bearing 23.NJ206ECP-1 '19 2x	S/E Bearing 21.1211 '19				

Footnotes: \* Bearings Only \*\* Rubbers included

**STREET**  
APRILIA  
CAGIVA  
HONDA  
KAWASAKI  
KTM  
SUZUKI  
YAMAHA

**ATV-UTV**  
CAN-AM  
GAS GAS  
HONDA  
KAWASAKI  
KTM  
POLARIS  
SUZUKI  
YAMAHA

**PWC**  
KAWASAKI  
POLARIS  
SEA DOO  
YAMAHA

**SNOW**  
ARCTIC CAT  
KAWASAKI  
LYNX  
MOTO-SKI  
POLARIS  
SKI DOO  
YAMAHA

**MOPED & SCOOTER**

**MISC. TECH. SPECIAL**

**DIRT**  
APRILIA  
BETA  
BMW  
GAS GAS  
HONDA  
HUSABERG  
HUSQVARNA  
KAWASAKI  
KTM  
MOTO TM  
RIEJU  
SHERCO  
SUZUKI  
YAMAHA

						Chain 07.RC428130C '03-22 MX		
Air Filter 52.73014 '18-23	Friction Set 16.S13013 '18-23	F/W Bearing 23.S110070 '18-23	Frontbrake Disc 37.BD17012 '18-23	Front Sprocket 07.FS73008-13 07.FS73008-14 '18-23	Chain 07.RC520120C '18-23 MX 07.RC520120CG '18-23 MX Gold 07.RC520120XC '18-23 X-Ring 07.RC520120XCG '18-23 X-Ring Gold	Swingarm 26.210196 '18-23	Seal & Wiper 40.S485810 22-23 KAYABA	Oil Seal Set 40.F485810 22-23 KAYABA
Main Jet 45.100-225 '18-23 Keihin	Steel Set 16.S71018 '18-23	R/W Bearing 23.S115056 '18-23	Rearbrake Disc 37.BD27012 '18-23	7075-T6 Alloy Rear Sprocket 07.RA62097-46 07.RA62097-47 07.RA62097-48 07.RA62097-49 07.RA62097-50 07.RA62097-51 07.RA62097-52 '18-23	Lower Chain Roller 33.0003 '18-23			Dust Seal Set 40.F4858D 22-23 KAYABA
Pilot Jet 46.040-085 '18-23 Keihin		Steering Bearing 24.110024 '18	Front Pad Set 37.102202 '18-23 37.102202BX '18-23 Box of 10	Rear Pad Set 37.202302 '18-23 37.202302BX '18-23 Box of 10	Ultralight Steel Rear Sprocket 07.RS62097R-46 07.RS62097R-47 07.RS62097R-48 07.RS62097R-49 07.RS62097R-50 07.RS62097R-51 07.RS62097R-52 '18-23			
Air Filter 52.73014 '19	Friction Set 16.S13013 '19	F/W Bearing 23.S110070 '19	Frontbrake Disc 37.BD17012 '19	Front Sprocket 07.FS73008-13 07.FS73008-14 '19	Chain 07.RC520120C '19 MX 07.RC520120CG '19 MX Gold 07.RC520120XC '19 X-Ring 07.RC520120XCG '19 X-Ring Gold	Swingarm 26.210196 '19		
Main Jet 45.100-225 '19 Keihin	Steel Set 16.S71018 '19	R/W Bearing 23.S115056 '19	Rearbrake Disc 37.BD27012 '19	7075-T6 Alloy Rear Sprocket 07.RA62097-46 07.RA62097-47 07.RA62097-48 07.RA62097-49 07.RA62097-50 07.RA62097-51 07.RA62097-52 '19	Lower Chain Roller 33.0003 '19			
Pilot Jet 46.040-085 '19 Keihin			Front Pad Set 37.102202 '19 37.102202BX '19 Box of 10	Rear Pad Set 37.202302 '19 37.202302BX '19 Box of 10	Ultralight Steel Rear Sprocket 07.RS62097R-46 07.RS62097R-47 07.RS62097R-48 07.RS62097R-49 07.RS62097R-50 07.RS62097R-51 07.RS62097R-52 '19			
					Sprocket Bolt Set 07.SBSM825 '19			

**STREET**  
APRILIA  
CAGIVA  
HONDA  
KAWASAKI  
KTM  
SUZUKI  
YAMAHA

**ATV-UTV**  
CAN-AM  
GAS GAS  
HONDA  
KAWASAKI  
KTM  
POLARIS  
SUZUKI  
YAMAHA

**PWC**  
KAWASAKI  
POLARIS  
SEA DOO  
YAMAHA

**SNOW**  
ARCTIC CAT  
KAWASAKI  
LYNX  
MOTO-SKI  
POLARIS  
SKI DOO  
YAMAHA

**MOPED & SCOOTER**

**MISC. TECH. SPECIAL**



### SHERCO

**DIRT**  
APRILIA  
BETA  
BMW  
GAS GAS  
HONDA  
HUSABERG  
HUSQVARNA  
KAWASAKI  
KTM  
MOTO TM  
RIEJU  
SHERCO  
SUZUKI  
YAMAHA

250 SE / SE-R 2-Stroke Please Note: Nikasil Piston Size -Forged Piston	<b>Piston Kit</b> 01.7334.A 01.7334.B 01.7334.C '14-16	<b>Size</b> 66.34 66.35 66.36	<b>Ring Set</b> 02.7307 02.7307 02.7307 '14-19	<b>Bearing</b> 23.NJ206ECP-1 '14-23 Left 23.6206C3 '14-23 Right	<b>S/E Bearing</b> 21.1316 '14-23  <b>B/E Bearing</b> 22.253216.5F '14-23	<b>Top-End</b> 35.7334 '14-18  <b>Head &amp; Base</b> 36.7334 '14-18				
Please Note: Nikasil Piston Size -Forged Piston	01.7337.A 01.7337.B 01.7337.C '17-23	66.34 66.35 66.36	02.7307 02.7307 02.7307 '17-23							
			<b>Pin</b> 04.1853.4 '17-23  <b>Clips</b> 05.1812 '14-23							

**STREET**  
APRILIA  
CAGIVA  
HONDA  
KAWASAKI  
KTM  
SUZUKI  
YAMAHA

250 SC-R 2-Stroke Please Note: Nikasil Piston Size -Forged Piston	<b>Piston Kit</b> 01.7337.A 01.7337.B 01.7337.C '19	<b>Size</b> 66.34 66.35 66.36	<b>Ring Set</b> 02.7307 02.7307 02.7307 '19	<b>Bearing</b> 23.NJ206ECP-1 '19 Left 23.6206C3 '19 Right	<b>S/E Bearing</b> 21.1316 '19  <b>B/E Bearing</b> 22.253216.5F '19					
			<b>Pin</b> 04.1853.4 '19  <b>Clips</b> 05.1812 '19							

**PWC**  
KAWASAKI  
POLARIS  
SEA DOO  
YAMAHA

**SNOW**  
ARCTIC CAT  
KAWASAKI  
LYNX  
MOTO-SKI  
POLARIS  
SKI DOO  
YAMAHA

**MOPED & SCOOTER**

**MISC. TECH. SPECIAL**

Footnotes: \* Bearings Only \*\* Rubbers included

<b>Air Filter</b> 52.73014 '14-23  <b>Main Jet</b> 45.100-225 '14-23 Keihin  <b>Pilot Jet</b> 46.040-085 '14-23 Keihin		<b>F/W Bearing</b> 23.S110070 '17-23  <b>R/W Bearing</b> 23.S115056 '17-23  <b>Steering Bearing</b> 24.110024 '14-23 SE	<b>Frontbrake Disc</b> 37.BD17012 '14-17 WP FORKS 37.BD17012 '18-23  <b>Rearbrake Disc</b> 37.BD27012 '14-23  <b>Front Pad Set</b> 37.102202 '17-23 37.102202BX '14-23 Box of 10  <b>Rear Pad Set</b> 37.202302 '17-23 37.202302BX '14-23 Box of 10	<b>Front Sprocket</b> 07.FS73004-13 07.FS73004-14 '14-20  <b>7075-T6 Alloy Rear Sprocket</b> 07.RA62097-46 07.RA62097-47 07.RA62097-48 07.RA62097-49 07.RA62097-50 07.RA62097-51 07.RA62097-52 '17-23  <b>Sprocket Bolt Set</b> 07.SBSM825 '17-23	<b>Chain</b> 07.RC520120C '14-23 MX 07.RC520120CG '14-23 MX Gold 07.RC520120XC '14-23 X-Ring 07.RC520120XCG '14-23 X-Ring Gold  <b>Lower Chain Roller</b> 33.0003 '14-16  <b>Upper Chain Roller</b> 33.0003 '17-23	<b>Swingarm</b> 26.210196 '14-23  <b>Seal &amp; Wiper</b> 40.S4857.89 '14-18 WP 40.S485810 19-23 KAYABA  <b>Oil Seal Set</b> 40.F4857.89 '14-18 WP 40.F485810 19-23 KAYABA  <b>Dust Seal Set</b> 40.F4857.8D '14-18 WP 40.F4858D 19-23 KAYABA
--	--	---	---	--	--	---

**DIRT**  
APRILIA  
BETA  
BMW  
GAS GAS  
HONDA  
HUSABERG  
HUSQVARNA  
KAWASAKI  
KTM  
MOTO TM  
RIEJU  
SHERCO  
SUZUKI  
YAMAHA

**STREET**  
APRILIA  
CAGIVA  
HONDA  
KAWASAKI  
KTM  
SUZUKI  
YAMAHA

**ATV-UTV**  
CAN-AM  
GAS GAS  
HONDA  
KAWASAKI  
KTM  
POLARIS  
SUZUKI  
YAMAHA

**PWC**  
KAWASAKI  
POLARIS  
SEA DOO  
YAMAHA

**SNOW**  
ARCTIC CAT  
KAWASAKI  
LYNX  
MOTO-SKI  
POLARIS  
SKI DOO  
YAMAHA

**MOPED & SCOOTER**

**MISC. TECH. SPECIAL**



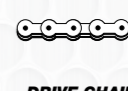

### SHERCO

**DIRT**  
APRILIA  
BETA  
BMW  
GAS GAS  
HONDA  
HUSABERG  
HUSQVARNA  
KAWASAKI  
KTM  
MOTO TM  
RIEJU  
SHERCO  
SUZUKI  
YAMAHA

SE 2.5 i-FR  
250 SE F / SE F-R  
4-Stroke  
Please Note:  
Nikasil Piston Size  
-Forged Piston  
-Fuel Injection  
-Std. Compression 13.2:1

<b>Piston Kit</b> 01.7314.A 01.7314.B 01.7314.C '14-18	<b>Size</b> 75.96 75.97 75.98	<b>Ring Set</b> 02.6336 02.6336 02.6336 '14-18	<b>Bearing</b> 23.NJ206ECP-1 '08-16 2x 23.NJ206ECP-2 '17-23 2x	<b>B/E Bearing</b> 22.303818F '08-20	<b>Top-End</b> 35.7314 '14-18	<b>Cam Chain</b> 31.1335 '08-23	<b>Head &amp; Base</b> 36.7314 '14-18	<b>Valve Shim Assortment</b> 29.VSA748 '14-23 29.VSA748-2 '14-23
		<b>Pin</b> 04.1641.6 '14-18	<b>Clips</b> 05.1610 '14-18					

**STREET**  
APRILIA  
CAGIVA  
HONDA  
KAWASAKI  
KTM  
SUZUKI  
YAMAHA

250 SC F  
4-Stroke  
Please Note:  
Nikasil Piston Size  
-Fuel Injection

<b>Piston Kit</b> - '19	<b>Size</b> 78.00	<b>Ring Set</b> - '19	<b>Bearing</b> 23.NJ206ECP-2 '19 2x			<b>Cam Chain</b> 31.1335 '19	<b>Valve Shim Assortment</b> 29.VSA748 '19 29.VSA748-2 '19
-------------------------------	----------------------	-----------------------------	---	--	--	------------------------------------	--

**ATV-UTV**  
CAN-AM  
GAS GAS  
HONDA  
KAWASAKI  
KTM  
POLARIS  
SUZUKI  
YAMAHA

250 SC F  
4-Stroke  
Please Note:  
Nikasil Piston Size  
-Fuel Injection

<b>Piston Kit</b> - '19	<b>Size</b> 78.00	<b>Ring Set</b> - '19	<b>Bearing</b> 23.NJ206ECP-2 '19 2x			<b>Cam Chain</b> 31.1335 '19	<b>Valve Shim Assortment</b> 29.VSA748 '19 29.VSA748-2 '19
-------------------------------	----------------------	-----------------------------	---	--	--	------------------------------------	--

**PWC**  
KAWASAKI  
POLARIS  
SEA DOO  
YAMAHA

250 SC F  
4-Stroke  
Please Note:  
Nikasil Piston Size  
-Fuel Injection

<b>Piston Kit</b> - '19	<b>Size</b> 78.00	<b>Ring Set</b> - '19	<b>Bearing</b> 23.NJ206ECP-2 '19 2x			<b>Cam Chain</b> 31.1335 '19	<b>Valve Shim Assortment</b> 29.VSA748 '19 29.VSA748-2 '19
-------------------------------	----------------------	-----------------------------	---	--	--	------------------------------------	--

**SNOW**  
ARCTIC CAT  
KAWASAKI  
LYNX  
MOTO-SKI  
POLARIS  
SKI DOO  
YAMAHA

250 SC F  
4-Stroke  
Please Note:  
Nikasil Piston Size  
-Fuel Injection

<b>Piston Kit</b> - '19	<b>Size</b> 78.00	<b>Ring Set</b> - '19	<b>Bearing</b> 23.NJ206ECP-2 '19 2x			<b>Cam Chain</b> 31.1335 '19	<b>Valve Shim Assortment</b> 29.VSA748 '19 29.VSA748-2 '19
-------------------------------	----------------------	-----------------------------	---	--	--	------------------------------------	--

**MOPED & SCOOTER**

250 SC F  
4-Stroke  
Please Note:  
Nikasil Piston Size  
-Fuel Injection

<b>Piston Kit</b> - '19	<b>Size</b> 78.00	<b>Ring Set</b> - '19	<b>Bearing</b> 23.NJ206ECP-2 '19 2x			<b>Cam Chain</b> 31.1335 '19	<b>Valve Shim Assortment</b> 29.VSA748 '19 29.VSA748-2 '19
-------------------------------	----------------------	-----------------------------	---	--	--	------------------------------------	--

**MISC. TECH. SPECIAL**

250 SC F  
4-Stroke  
Please Note:  
Nikasil Piston Size  
-Fuel Injection

<b>Piston Kit</b> - '19	<b>Size</b> 78.00	<b>Ring Set</b> - '19	<b>Bearing</b> 23.NJ206ECP-2 '19 2x			<b>Cam Chain</b> 31.1335 '19	<b>Valve Shim Assortment</b> 29.VSA748 '19 29.VSA748-2 '19
-------------------------------	----------------------	-----------------------------	---	--	--	------------------------------------	--

Footnotes: \* Bearings Only \*\* Rubbers included

<b>Air Filter</b> 52.73023 '13-23		<b>Friction Set</b> 16.S73008 '08-10 16.S73011 '11-23	<b>F/W Bearing</b> 23.S110070 '08-23	<b>Frontbrake Disc</b> 37.BD17012 '13 37.BD17012 '14-17 WP FORKS 37.BD17012 '18-23	<b>Front Sprocket</b> 07.FS73008-13 07.FS73008-14 '08-20	<b>Chain</b> 07.RC520120C '08-23 MX 07.RC520120CG '08-23 MX Gold 07.RC520120XC '08-23 X-Ring 07.RC520120XCG '08-23 X-Ring Gold	<b>Swingarm</b> 26.210196 '08-23	<b>Seal &amp; Wiper</b> 40.S4857.89 '14-18 WP 40.S485810 22-23 KAYABA
		<b>Steel Set</b> 16.S73018 '08-23	<b>R/W Bearing</b> 23.S115056 '08-23	<b>Steering Bearing</b> 24.110024 '08-23	<b>Rearbrake Disc</b> 37.BD27012 '13-23	<b>7075-T6 Alloy Rear Sprocket</b> 07.RA62097-46 07.RA62097-47 07.RA62097-48 07.RA62097-49 07.RA62097-50 07.RA62097-51 07.RA62097-52 '08-23	<b>Lower Chain Roller</b> 33.0003 '08-16	<b>Oil Seal Set</b> 40.F4857.89 '14-18 WP 40.F485810 22-23 KAYABA
					<b>Front Pad Set</b> 37.102202 '08-23 37.102202BX '08-23 Box of 10	<b>UltraLight Steel Rear Sprocket</b> 07.RS62097R-46 07.RS62097R-47 07.RS62097R-48 07.RS62097R-49 07.RS62097R-50 07.RS62097R-51 07.RS62097R-52 '08-23	<b>Upper Chain Roller</b> 33.0003 '08-23	<b>Dust Seal Set</b> 40.F4857.8D '14-18 WP 40.F4858D 22-23 KAYABA
					<b>Rear Pad Set</b> 37.201302 '08-11 37.201302BX '08-11 Box of 10 37.202302 '12-23 37.202302BX '12-23 Box of 10	<b>Sprocket Bolt Set</b> 07.SBSM825 '08-23		

<b>Air Filter</b> 52.73023 '19		<b>Friction Set</b> 16.S73011 '19	<b>F/W Bearing</b> 23.S110070 '19	<b>Frontbrake Disc</b> 37.BD17012 '19	<b>Front Sprocket</b> 07.FS73008-13 07.FS73008-14 '19	<b>Chain</b> 07.RC520120C '19 MX 07.RC520120CG '19 MX Gold 07.RC520120XC '19 X-Ring 07.RC520120XCG '19 X-Ring Gold	<b>Swingarm</b> 26.210196 '19	
		<b>Steel Set</b> 16.S73018 '19	<b>R/W Bearing</b> 23.S115056 '19	<b>Rearbrake Disc</b> 37.BD27012 '19	<b>7075-T6 Alloy Rear Sprocket</b> 07.RA62097-46 07.RA62097-47 07.RA62097-48 07.RA62097-49 07.RA62097-50 07.RA62097-51 07.RA62097-52 '19	<b>Upper Chain Roller</b> 33.0003 '19		
				<b>Front Pad Set</b> 37.102202 '19 37.102202BX '19 Box of 10	<b>UltraLight Steel Rear Sprocket</b> 07.RS62097R-46 07.RS62097R-47 07.RS62097R-48 07.RS62097R-49 07.RS62097R-50 07.RS62097R-51 07.RS62097R-52 '19	<b>Sprocket Bolt Set</b> 07.SBSM825 '19		
				<b>Rear Pad Set</b> 37.202302 '19 37.202302BX '19 Box of 10				

**DIRT**  
APRILIA  
BETA  
BMW  
GAS GAS  
HONDA  
HUSABERG  
HUSQVARNA  
KAWASAKI  
KTM  
MOTO TM  
RIEJU  
SHERCO  
SUZUKI  
YAMAHA

**STREET**  
APRILIA  
CAGIVA  
HONDA  
KAWASAKI  
KTM  
SUZUKI  
YAMAHA

**ATV-UTV**  
CAN-AM  
GAS GAS  
HONDA  
KAWASAKI  
KTM  
POLARIS  
SUZUKI  
YAMAHA

**PWC**  
KAWASAKI  
POLARIS  
SEA DOO  
YAMAHA

**SNOW**  
ARCTIC CAT  
KAWASAKI  
LYNX  
MOTO-SKI  
POLARIS  
SKI DOO  
YAMAHA

**MOPED & SCOOTER**

**MISC. TECH. SPECIAL**

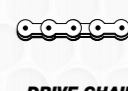

**SHERCO**

**DIRT**  
APRILIA  
BETA  
BMW  
GAS GAS  
HONDA  
HUSABERG  
HUSQVARNA  
KAWASAKI  
KTM  
MOTO TM  
RIEJU  
SHERCO  
SUZUKI  
YAMAHA

300 SE / SE-R 2-Stroke Please Note: Nikasil Piston Size -Forged Piston	<b>Piston Kit</b> 01.7346.A 01.7346.B 01.7346.C '16-23	<b>Size</b> 71.94 71.95 71.96	<b>Ring Set</b> 02.6396 02.6396 02.6396 '14-23  <b>Clips</b> 05.1812 '14-23	<b>Bearing</b> 23.NJ206ECP-1 '14-23 Left 23.6206C3 '14-23 Right	<b>S/E Bearing</b> 21.1316 '14-23  <b>B/E Bearing</b> 22.253216.5F '14-23	<b>Top-End</b> 35.7334 '14-18  <b>Head &amp; Base</b> 36.7334 '14-18			
--	--	--	---	---	---	--	--	--	--

**STREET**  
APRILIA  
CAGIVA  
HONDA  
KAWASAKI  
KTM  
SUZUKI  
YAMAHA

300 SC-R 2-Stroke Please Note: Nikasil Piston Size -Forged Piston	<b>Piston Kit</b> 01.7346.A 01.7346.B 01.7346.C '19	<b>Size</b> 71.94 71.95 71.96	<b>Ring Set</b> 02.6396 02.6396 02.6396 '19  <b>Clips</b> 05.1812 '19	<b>Bearing</b> 23.NJ206ECP-1 '19 Left 23.6206C3 '19 Right	<b>S/E Bearing</b> 21.1316 '19  <b>B/E Bearing</b> 22.253216.5F '19				
---	---	--	---	---	---	--	--	--	--

**PWC**  
KAWASAKI  
POLARIS  
SEA DOO  
YAMAHA

--	--	--	--	--	--	--	--	--	--

**SNOW**  
ARCTIC CAT  
KAWASAKI  
LYNX  
MOTO-SKI  
POLARIS  
SKI DOO  
YAMAHA

--	--	--	--	--	--	--	--	--	--

**MOPED & SCOOTER**

--	--	--	--	--	--	--	--	--	--

**MISC. TECH. SPECIAL**

--	--	--	--	--	--	--	--	--	--

Footnotes: \* Bearings Only \*\* Rubbers included

<b>Air Filter</b> 52.73014 '14-23  <b>Main Jet</b> 45.100-225 '14-23 Keihin  <b>Pilot Jet</b> 46.040-085 '14-23 Keihin		<b>F/W Bearing</b> 23.S110070 '14-23  <b>R/W Bearing</b> 23.S115056 '14-23  <b>Steering Bearing</b> 24.110024 '14-23 SE	<b>Frontbrake Disc</b> 37.BD17012 '14-17 WP FORKS 37.BD17012 '18-23  <b>Rearbrake Disc</b> 37.BD27012 '14-23  <b>Front Pad Set</b> 37.102202 '14-23 37.102202BX '14-23 Box of 10  <b>Rear Pad Set</b> 37.202302 '14-23 37.202302BX '14-23 Box of 10	<b>Front Sprocket</b> 07.FS73004-13 07.FS73004-14 '14-20  <b>7075-T6 Alloy Rear Sprocket</b> 07.RA62097-46 07.RA62097-47 07.RA62097-48 07.RA62097-49 07.RA62097-50 07.RA62097-51 07.RA62097-52 '14-23  <b>UltraLight Steel Rear Sprocket</b> 07.RS62097R-46 07.RS62097R-47 07.RS62097R-48 07.RS62097R-49 07.RS62097R-50 07.RS62097R-51 07.RS62097R-52 '14-23  <b>Sprocket Bolt Set</b> 07.SBSM825 '14-23	<b>Chain</b> 07.RC520120C '14-23 MX 07.RC520120CG '14-23 MX Gold 07.RC520120XC '14-23 X-Ring 07.RC520120XCG '14-23 X-Ring Gold  <b>Lower Chain Roller</b> 33.0003 '14-16  <b>Upper Chain Roller</b> 33.0003 '14-23	<b>Swingarm</b> 26.210196 '14-23	<b>Seal &amp; Wiper</b> 40.S4857.89 '14-18 WP 40.S485810 19-23 KAYABA  <b>Oil Seal Set</b> 40.F4857.89 '14-18 WP 40.F485810 19-23 KAYABA  <b>Dust Seal Set</b> 40.F4857.8D '14-18 WP 40.F4858D 19-23 KAYABA
--	--	---	---	---	--	--	---

**DIRT**  
APRILIA  
BETA  
BMW  
GAS GAS  
HONDA  
HUSABERG  
HUSQVARNA  
KAWASAKI  
KTM  
MOTO TM  
RIEJU  
SHERCO  
SUZUKI  
YAMAHA

**STREET**  
APRILIA  
CAGIVA  
HONDA  
KAWASAKI  
KTM  
SUZUKI  
YAMAHA

**ATV-UTV**  
CAN-AM  
GAS GAS  
HONDA  
KAWASAKI  
KTM  
POLARIS  
SUZUKI  
YAMAHA

**PWC**  
KAWASAKI  
POLARIS  
SEA DOO  
YAMAHA

**SNOW**  
ARCTIC CAT  
KAWASAKI  
LYNX  
MOTO-SKI  
POLARIS  
SKI DOO  
YAMAHA

**MOPED & SCOOTER**

**MISC. TECH. SPECIAL**

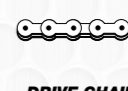

### SHERCO

<b>DIRT</b> APRILIA BETA BMW GAS GAS HONDA HUSABERG HUSQVARNA KAWASAKI KTM MOTO TM RIEJU SHERCO SUZUKI YAMAHA	SE 3.0 i-FR 300 SE F / SE F-R 4-Stroke Please Note: Nikasil Piston Size -Forged Piston -Fuel Injection -Std. Compression 12.85:1	<b>Piston Kit</b> 01.7324.A 01.7324.B 01.7324.C '14-17	<b>SIZES (mm)</b> 83.95 83.96 83.97	<b>Ring Set</b> 02.7324 02.7324 02.7324 '14-17  <b>Pin</b> 04.1639.9 '14-17  <b>Clips</b> 05.1610 '14-17	<b>Bearing</b> 23.NJ206ECP-1 '10-16 2x 23.NJ206ECP-2 '16-23 2x From Crankcase 5015 !	<b>B/E Bearing</b> 22.303818F '10-20	<b>Top-End</b> 35.7324 '14-19  <b>Head &amp; Base</b> 36.7324 '14-22	<b>Cam Chain</b> 31.1335 '10-23  <b>Valve Shim Assortment</b> 29.VSA748 '14-23 29.VSA748-2 '14-23	
	<b>ATV-UTV</b> CAN-AM GAS GAS HONDA KAWASAKI KTM POLARIS SUZUKI YAMAHA	300 SC F 4-Stroke Please Note: Nikasil Piston Size -Fuel Injection	<b>Piston Kit</b> - '19	<b>Size</b> 84.00	<b>Ring Set</b> - '19	<b>Bearing</b> 23.NJ206ECP-2 '19 2x		<b>Top-End</b> 35.7324 '19  <b>Head &amp; Base</b> 36.7324 '19	<b>Cam Chain</b> 31.1335 '19  <b>Valve Shim Assortment</b> 29.VSA748 '19 29.VSA748-2 '19

Footnotes: \* Bearings Only \*\* Rubbers included

<b>Air Filter</b> 52.73023 '13-23		<b>Friction Set</b> 16.S73008 '10 16.S73011 '11-23  <b>Steel Set</b> 16.S73018 '10-23	<b>F/W Bearing</b> 23.S110070 '10-23  <b>R/W Bearing</b> 23.S115056 '10-23  <b>Steering Bearing</b> 24.110024 '10-23	<b>Frontbrake Disc</b> 37.BD17012 '13 37.BD17012 '14-17 WP FORKS 37.BD17012 '18-23  <b>Rearbrake Disc</b> 37.BD27012 '13-23  <b>Front Pad Set</b> 37.102202 '10-23 37.102202BX '10-23 Box of 10  <b>Rear Pad Set</b> 37.201302 '10-11 37.201302BX '10-11 Box of 10 37.202302 '12-23 37.202302BX '12-23 Box of 10	<b>Front Sprocket</b> 07.FS73008-13 07.FS73008-14 '10-20  <b>7075-T6 Alloy Rear Sprocket</b> 07.RA62097-46 07.RA62097-47 07.RA62097-48 07.RA62097-49 07.RA62097-50 07.RA62097-51 07.RA62097-52 '10-23  <b>UltraLight Steel Rear Sprocket</b> 07.RS62097R-46 07.RS62097R-47 07.RS62097R-48 07.RS62097R-49 07.RS62097R-50 07.RS62097R-51 07.RS62097R-52 '10-23  <b>Sprocket Bolt Set</b> 07.SBSM825 '10-23	<b>Chain</b> 07.RC520120C '10-23 MX 07.RC520120CG '10-23 MX Gold 07.RC520120XC '10-23 X-Ring 07.RC520120XCG '10-23 X-Ring Gold  <b>Lower Chain Roller</b> 33.0003 '10-16  <b>Upper Chain Roller</b> 33.0003 '10-23	<b>Swingarm</b> 26.210196 '10-23	<b>Seal &amp; Wiper</b> 40.S4857.89 '14-18 WP 40.S485810 22-23 KAYABA  <b>Oil Seal Set</b> 40.F4857.89 '14-18 WP 40.F485810 22-23 KAYABA  <b>Dust Seal Set</b> 40.F4857.8D '14-18 WP 40.F4858D 22-23 KAYABA
<b>Air Filter</b> 52.73023 '19		<b>Friction Set</b> 16.S73011 '19  <b>Steel Set</b> 16.S73018 '19	<b>F/W Bearing</b> 23.S110070 '19  <b>R/W Bearing</b> 23.S115056 '19	<b>Frontbrake Disc</b> 37.BD17012 '19  <b>Rearbrake Disc</b> 37.BD27012 '19  <b>Front Pad Set</b> 37.102202 '19 37.102202BX '19 Box of 10  <b>Rear Pad Set</b> 37.202302 '19 37.202302BX '19 Box of 10	<b>Front Sprocket</b> 07.FS73008-13 07.FS73008-14 '19  <b>7075-T6 Alloy Rear Sprocket</b> 07.RA62097-46 07.RA62097-47 07.RA62097-48 07.RA62097-49 07.RA62097-50 07.RA62097-51 07.RA62097-52 '19  <b>UltraLight Steel Rear Sprocket</b> 07.RS62097R-46 07.RS62097R-47 07.RS62097R-48 07.RS62097R-49 07.RS62097R-50 07.RS62097R-51 07.RS62097R-52 '19  <b>Sprocket Bolt Set</b> 07.SBSM825 '19	<b>Chain</b> 07.RC520120C '19 MX 07.RC520120CG '19 MX Gold 07.RC520120XC '19 X-Ring 07.RC520120XCG '19 X-Ring Gold  <b>Upper Chain Roller</b> 33.0003 '19	<b>Swingarm</b> 26.210196 '19	

### STREET

### ATV-UTV

### PWC

### SNOW

### MOPED & SCOOTER

### MISC. TECH. SPECIAL

**DIRT**  
APRILIA  
BETA  
BMW  
GAS GAS  
HONDA  
HUSABERG  
HUSQVARNA  
KAWASAKI  
KTM  
MOTO TM  
RIEJU  
SHERCO  
SUZUKI  
YAMAHA

**STREET**  
APRILIA  
CAGIVA  
HONDA  
KAWASAKI  
KTM  
SUZUKI  
YAMAHA

**ATV-UTV**  
CAN-AM  
GAS GAS  
HONDA  
KAWASAKI  
KTM  
POLARIS  
SUZUKI  
YAMAHA

**PWC**  
KAWASAKI  
POLARIS  
SEA DOO  
YAMAHA

**SNOW**  
ARCTIC CAT  
KAWASAKI  
LYNX  
MOTO-SKI  
POLARIS  
SKI DOO  
YAMAHA

**MOPED & SCOOTER**

**MISC. TECH. SPECIAL**



**SHERCO**

	Piston Kit	Size (mm)	Ring Set	Bearing
<b>DIRT</b>	SE 4.5 i SE 4.5 i-FR SM 4.5 i 4-Stroke Please Note: Nikasil Piston Size -Forged Piston -Fuel Injection	94.50 '04-08 95.00 '09-13	-	23.NJ206ECP-1 '04-13 2x
<b>STREET</b>				
<b>ATV-UTV</b>	450 SE F-R 4-Stroke Please Note: Nikasil Piston Size -Forged Piston -Fuel Injection	95.00	-	23.NJ206ECP-2 '15-21 2x
<b>PWC</b>				
<b>SNOW</b>				
<b>MOPED &amp; SCOOTER</b>				
<b>MISC. TECH. SPECIAL</b>				

Footnotes: \* Bearings Only \*\* Rubbers included

F/W Bearing	Front Pad Set	Front Sprocket	Chain	Swingarm
23.S110070 '04-13 R/W Bearing 23.S115056 '04-13 Steering Bearing 24.110024 '04-13	37.102202 '04-13 37.102202BX '04-13 Box of 10 Rear Pad Set 37.201302 '04-13 37.201302BX '04-13 Box of 10	07.FS73004-13 07.FS73004-14 '04-13 7075-T6 Alloy Rear Sprocket 07.RA62097-46 07.RA62097-47 07.RA62097-48 07.RA62097-49 07.RA62097-50 07.RA62097-51 07.RA62097-52 '04-13 UltraLight Steel Rear Sprocket 07.RS62097R-46 07.RS62097R-47 07.RS62097R-48 07.RS62097R-49 07.RS62097R-50 07.RS62097R-51 07.RS62097R-52 '04-13 Sprocket Bolt Set 07.SBSM825 '04-13	07.RC520120C '04-13 MX 07.RC520120CG '04-13 MX Gold 07.RC520120XC '04-13 X-Ring 07.RC520120XCG '04-13 X-Ring Gold Lower Chain Roller 33.0003 '04-16 SE '04-08 SM Upper Chain Roller 33.0003 '04-17 SE '04-08 SM	26.210196 '04-13
Air Filter 52.73023 '15-23				
23.S110070 '15-23 R/W Bearing 23.S115056 '15-23 Steering Bearing 24.110024 '15-23	37.BD17012 '15-17 WP FORKS 37.BD17012 '18-23 Rearbrake Disc 37.BD27012 '15-23 Front Pad Set 37.102202 '15-23 37.102202BX '15-23 Box of 10 Rear Pad Set 37.202302 '15-23 37.202302BX '15-23 Box of 10	07.FS73004-13 07.FS73004-14 '15-23 7075-T6 Alloy Rear Sprocket 07.RA62097-46 07.RA62097-47 07.RA62097-48 07.RA62097-49 07.RA62097-50 07.RA62097-51 07.RA62097-52 '15-23 UltraLight Steel Rear Sprocket 07.RS62097R-46 07.RS62097R-47 07.RS62097R-48 07.RS62097R-49 07.RS62097R-50 07.RS62097R-51 07.RS62097R-52 '15-23 Sprocket Bolt Set 07.SBSM825 '15-23	07.RC520120C '15-23 MX 07.RC520120CG '15-23 MX Gold 07.RC520120XC '15-23 X-Ring 07.RC520120XCG '15-23 X-Ring Gold Upper Chain Roller 33.0003 '15-23 Dust Seal Set 40.F4857.8D '15-18 WP 40.F4858D 22-23 KAYABA	40.S4857.89 '15-18 WP 40.S485810 22-23 KAYABA Oil Seal Set 40.F4857.89 '15-18 WP 40.F485810 22-23 KAYABA Dust Seal Set 40.F4857.8D '15-18 WP 40.F4858D 22-23 KAYABA

**DIRT**

APRILIA  
BETA  
BMW  
GAS GAS  
HONDA  
HUSABERG  
HUSQVARNA  
KAWASAKI  
KTM  
MOTO TM  
RIEJU  
SHERCO  
SUZUKI  
YAMAHA

**STREET**

APRILIA  
CAGIVA  
HONDA  
KAWASAKI  
KTM  
SUZUKI  
YAMAHA

**ATV-UTV**

CAN-AM  
GAS GAS  
HONDA  
KAWASAKI  
KTM  
POLARIS  
SUZUKI  
YAMAHA

**PWC**

KAWASAKI  
POLARIS  
SEA DOO  
YAMAHA

**SNOW**

ARCTIC CAT  
KAWASAKI  
LYNX  
MOTO-SKI  
POLARIS  
SKI DOO  
YAMAHA

**MOPED & SCOOTER**

**MISC. TECH. SPECIAL**





PISTON KITS



SIZES (mm)



PISTON PARTS



CRANKSHAFT PARTS



CONNECTING ROD PARTS



GASKETS



VALVE TRAIN PARTS I



VALVE TRAIN PARTS II



AIR & FUEL PARTS



CLUTCH PARTS



CLUTCH PLATE SETS



WHEEL & STEERING PARTS



BRAKE PARTS



DRIVE CHAIN PARTS I



DRIVE CHAIN PARTS II



SUSPENSION BEARING KITS



SUSPENSION PARTS



# SHERCO

	450 SC F																					
<b>DIRT</b> APRILIA BETA BMW GAS GAS HONDA HUSABERG HUSQVARNA KAWASAKI KTM MOTO TM RIEJU SHERCO SUZUKI YAMAHA	450 SC F 4-Stroke Please Note: Nikasil Piston Size -Forged Piston -Fuel Injection	Piston Kit -	Size 95.00	Ring Set -	Bearing 23.NJ206ECP-2 '19 2x																<b>DIRT</b> APRILIA BETA BMW GAS GAS HONDA HUSABERG HUSQVARNA KAWASAKI KTM MOTO TM RIEJU SHERCO SUZUKI YAMAHA	
<b>STREET</b> APRILIA CAGIVA HONDA KAWASAKI KTM SUZUKI YAMAHA																						<b>STREET</b> APRILIA CAGIVA HONDA KAWASAKI KTM SUZUKI YAMAHA
<b>ATV-UTV</b> CAN-AM GAS GAS HONDA KAWASAKI KTM POLARIS SUZUKI YAMAHA	500 SE F-R 4-Stroke Please Note: Nikasil Piston Size -Forged Piston -Fuel Injection	Piston Kit -	Size 98.00	Ring Set -	Bearing 23.NJ206ECP-2 '21-22 2x																	<b>ATV-UTV</b> CAN-AM GAS GAS HONDA KAWASAKI KTM POLARIS SUZUKI YAMAHA
<b>PWC</b> KAWASAKI POLARIS SEA DOO YAMAHA																						<b>PWC</b> KAWASAKI POLARIS SEA DOO YAMAHA
<b>SNOW</b> ARCTIC CAT KAWASAKI LYNX MOTO-SKI POLARIS SKI DOO YAMAHA																						<b>SNOW</b> ARCTIC CAT KAWASAKI LYNX MOTO-SKI POLARIS SKI DOO YAMAHA
<b>MOPED &amp; SCOOTER</b>																						<b>MOPED &amp; SCOOTER</b>
<b>MISC. TECH. SPECIAL</b>																						<b>MISC. TECH. SPECIAL</b>

Footnotes: \* Bearings Only \*\* Rubbers included



**SHERCO**

**DIRT**  
APRILIA  
BETA  
BMW  
GAS GAS  
HONDA  
HUSABERG  
HUSQVARNA  
KAWASAKI  
KTM  
MOTO TM  
RIEJU  
SHERCO  
SUZUKI  
YAMAHA

SE 5.1 i SE 5.1 i-FR SM 5.1 i 4-Stroke Please Note: Nikasil Piston Size -Forged Piston -Fuel Injection	Piston Kit -	Size 95.00	Ring Set -	Bearing 23.NJ206ECP-1 '07-13 2x					
---	-----------------	---------------	---------------	---------------------------------------	--	--	--	--	--

**SUZUKI**

**STREET**  
APRILIA  
CAGIVA  
HONDA  
KAWASAKI  
KTM  
SUZUKI  
YAMAHA

RM 60 2-Stroke Please Note: Nikasil Piston Size	Piston Kit 01.4100.A 01.4100.B '03	Size 42.95 42.96	Ring Set 02.4100 02.4100 '03	Crank Bearing & Seal Kit 23.CBS41088 '03	Con. Rod Kit 03.4022 '03	Complete 34.4100 '03			
			Pin 04.1236.4 '03	Bearing 23.6304C3 '03 2x	S/E Bearing 21.4100 '03	Top-End 35.4100.90 '03			
			Clips 05.1210C-1 '03	Oilseal Set 42.4105 '03	B/E Bearing 22.202714F '03	Head & Base 36.4185 '03			
					Crankpin 06.2046 '03				

Footnotes: \* Bearings Only \*\* Rubbers included

			F/W Bearing 23.S110070 '07-13	Front Pad Set 37.102202 '07-13 37.102202BX '07-13 Box of 10	Front Sprocket 07.FS73004-13 07.FS73004-14 '07-13	Chain 07.RC520120C '07-13 MX 07.RC520120CG '07-13 MX Gold 07.RC520120XC '07-13 X-Ring 07.RC520120XCG '07-13 X-Ring Gold	Swingarm 26.210196 '07-13		
			R/W Bearing 23.S115056 '07-13	Rear Pad Set 37.201302 '07-13 37.201302BX '07-13 Box of 10	7075-T6 Alloy Rear Sprocket 07.RA62097-46 07.RA62097-47 07.RA62097-48 07.RA62097-49 07.RA62097-50 07.RA62097-51 07.RA62097-52 '07-13	Lower Chain Roller 33.0003 '07-13			
			Steering Bearing 24.110024 '07-13		UltraLight Steel Rear Sprocket 07.RS62097R-46 07.RS62097R-47 07.RS62097R-48 07.RS62097R-49 07.RS62097R-50 07.RS62097R-51 07.RS62097R-52 '07-13	Upper Chain Roller 33.0003 '07-13			
					Sprocket Bolt Set 07.SBSM825 '07-13				

Air Filter 52.40086 '03	Basket 17.4085F '03	Complete Plate Set 16.CPS41088 '03	F/W Bearing 23.S111065 '03	Front Sprocket 07.FS41086-12 07.FS41086-13 07.FS41086-14 07.FS41086-15 '03	Chain 07.RC420130C '03 MX	Swingarm 26.210067 '03			
Throttle Cable 53.112004 '03	Spring Kit 17.CS40012 '03	Friction Set 16.S41001 '03	R/W Bearing 23.S111081 '03	Countershaft Seal Kit 26.640018 '03	Linkage 26.110059 '03				
Water Pump Rebuild Kit 57.3023 '03	Cover Gasket 19.G4085 '03	Steel Set 16.S41002 '03	Steering Bearing 24.110040 '03	Lower Chain Roller 33.0009 '03	Lower 26.450040 '03				
	Clutch Cable 53.121005 '03			Upper Chain Roller 33.0009 '03					

**PWC**  
KAWASAKI  
POLARIS  
SEA DOO  
YAMAHA

**SNOW**  
ARCTIC CAT  
KAWASAKI  
LYNX  
MOTO-SKI  
POLARIS  
SKI DOO  
YAMAHA

**MOPED & SCOOTER**

**MISC. TECH. SPECIAL**

**DIRT**  
APRILIA  
BETA  
BMW  
GAS GAS  
HONDA  
HUSABERG  
HUSQVARNA  
KAWASAKI  
KTM  
MOTO TM  
RIEJU  
SHERCO  
SUZUKI  
YAMAHA

**STREET**  
APRILIA  
CAGIVA  
HONDA  
KAWASAKI  
KTM  
SUZUKI  
YAMAHA

**ATV-UTV**  
CAN-AM  
GAS GAS  
HONDA  
KAWASAKI  
KTM  
POLARIS  
SUZUKI  
YAMAHA

**PWC**  
KAWASAKI  
POLARIS  
SEA DOO  
YAMAHA

**SNOW**  
ARCTIC CAT  
KAWASAKI  
LYNX  
MOTO-SKI  
POLARIS  
SKI DOO  
YAMAHA

**MOPED & SCOOTER**

**MISC. TECH. SPECIAL**



### SUZUKI

**DIRT**  
APRILIA  
BETA  
BMW  
GAS GAS  
HONDA  
HUSABERG  
HUSQVARNA  
KAWASAKI  
KTM  
MOTO TM  
RIEJU  
SHERCO  
SUZUKI  
YAMAHA

RM 65 2-Stroke Please Note: Nikasil Piston Size -Molycoated Skirt	<b>Piston Kit</b> 01.4022.A 01.4022.B 01.4022.C 01.4022.D '03-05	<b>Size</b> 44.45 44.46 44.47 44.48	<b>Ring Set</b> 02.4021 02.4021 02.4021 02.4021 '03-05	<b>CrankBearing &amp; Seal Kit</b> 23.CBS41088 '03-05	<b>Con. Rod Kit</b> 03.4022 '03-05	<b>Complete</b> 34.4021 '03-05		
			<b>Pin</b> 04.1236.4 '03-05	<b>Bearing</b> 23.6304C3 '03-05 2x	<b>S/E Bearing</b> 21.4100 '03-05	<b>Top-End</b> 35.4021 '03-05		
			<b>Oilseal Set</b> 42.4105 '03-05		<b>B/E Bearing</b> 22.202714F '03-05	<b>Head &amp; Base</b> 36.4100 '03-05		
			<b>Clips</b> 05.1210C-1 '03-05		<b>Crankpin</b> 06.2046 '03-05	<b>Ignition Cover Gasket</b> 19.G94085 '03-05		

**STREET**  
APRILIA  
CAGIVA  
HONDA  
KAWASAKI  
KTM  
SUZUKI  
YAMAHA

RM 80 2-Stroke International Bore 79cc	<b>Piston Kit</b> - '86-90	<b>Size</b> 47.00	<b>Ring Set</b> - '86-90	<b>CrankBearing &amp; Seal Kit</b> 23.CBS31089 '89-98 23.CBS31099 '99-01	<b>Con. Rod Kit</b> 03.3108 '90-01	<b>Complete</b> 34.3111 '91-01		
			<b>Pin</b> 04.1441 '91-01	<b>Bearing</b> 23.6204C3 '83-88 Left 23.6304C3 '86-88 Right 23.6304C3 '89-01 2x	<b>S/E Bearing</b> 21.3103 '83-01	<b>Top-End</b> 35.3110 '90 35.3111 '91-01		
			<b>Clips</b> 05.1410C '83-01	<b>Oilseal Set</b> 42.3109 '89-98 42.3219 '99-01	<b>B/E Bearing</b> 22.202614F '90-01	<b>Head &amp; Base</b> 36.3191 '91-01		
					<b>Crankpin</b> 06.2045 '90-01	<b>Ignition Cover Gasket</b> 19.G93189 '89-01		

**PWC**  
KAWASAKI  
POLARIS  
SEA DOO  
YAMAHA

**SNOW**  
ARCTIC CAT  
KAWASAKI  
LYNX  
MOTO-SKI  
POLARIS  
SKI DOO  
YAMAHA

**MOPED & SCOOTER**

**MISC. TECH. SPECIAL**

Footnotes: \* Bearings Only \*\* Rubbers included

<b>Air Filter</b> 52.40000 '03-05	<b>Basket</b> 17.4085F '03-05	<b>Complete Plate Set</b> 16.CPS41088 '03-05	<b>F/W Bearing</b> 23.S111081 '03-05	<b>Frontbrake Disc</b> 37.BD14000 '03-05	<b>Front Sprocket</b> 07.FS41086-12 07.FS41086-13 07.FS41086-14 07.FS41086-15 '03-05	<b>Chain</b> 07.RC420130C '03-05 MX	<b>Swingarm</b> 26.210067 '03-05	<b>Seal &amp; Wiper</b> 40.S334611P '03-05
<b>Main Jet</b> 47.090-580 '03-05	<b>Spring Kit</b> 17.CS40012 '03-05	<b>Friction Set</b> 16.S41001 '03-05	<b>R/W Bearing</b> 23.S111081 '03-05	<b>Rearbrake Disc</b> 37.BD14000 '03-05	<b>Countershaft Seal Kit</b> 26.640018 '03-05	<b>Lower Chain Roller</b> 33.0009 '03-05	<b>Linkage</b> 26.110011 '03-05	<b>Oil Seal Set</b> 40.F334611P '03-05
<b>Pilot Jet</b> 48.015-080 '03-05	<b>Cover Gasket</b> 19.G4090 '03-05	<b>Steel Set</b> 16.S41002 '03-05	<b>F/W Spacer Kit</b> 26.710024 '03-05	<b>Front Pad Set</b> 37.107202 '03-05 37.107202BX '03-05 Box of 10	<b>7075-T6 Alloy Rear Sprocket</b> 07.RA40000-46 07.RA40000-47 07.RA40000-48 '03-05	<b>Upper Chain Roller</b> 33.0009 '03-05	<b>Lower</b> 26.450022 '03-05	<b>Dust Seal Set</b> 40.F3346DP '03-05
<b>Carburetor Rebuild Kit</b> 55.10108 '03-05	<b>Clutch Cable</b> 53.121006 '03-05		<b>Steering Bearing</b> 24.110022 '03-05	<b>Rear Pad Set</b> 37.202002 '03-05 37.202002BX '03-05 Box of 10	<b>Sprocket Bolt Set</b> 07.SBSM825 '03-05			<b>Rear Shock Seal Head Kit</b> 26.810005 '03-05
<b>Throttle Cable</b> 53.112004 '03-05				<b>Front Caliper Rebuild Kit</b> 37.63001 '03-05				
<b>Water Pump Rebuild Kit</b> 57.4023 '03-05				<b>Rear Caliper Rebuild Kit</b> 37.63033 '03-05				
				<b>Front Master Cylinder Rebuild Kit</b> 37.910010 '03-05				
				<b>Rear Master Cylinder Rebuild Kit</b> 37.910007 '03-05				

**DIRT**  
APRILIA  
BETA  
BMW  
GAS GAS  
HONDA  
HUSABERG  
HUSQVARNA  
KAWASAKI  
KTM  
MOTO TM  
RIEJU  
SHERCO  
SUZUKI  
YAMAHA

**STREET**  
APRILIA  
CAGIVA  
HONDA  
KAWASAKI  
KTM  
SUZUKI  
YAMAHA

**ATV-UTV**  
CAN-AM  
GAS GAS  
HONDA  
KAWASAKI  
KTM  
POLARIS  
SUZUKI  
YAMAHA

**PWC**  
KAWASAKI  
POLARIS  
SEA DOO  
YAMAHA

**SNOW**  
ARCTIC CAT  
KAWASAKI  
LYNX  
MOTO-SKI  
POLARIS  
SKI DOO  
YAMAHA

**MOPED & SCOOTER**

**MISC. TECH. SPECIAL**

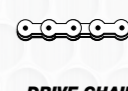

SUZUKI

DIRT  
APRILIA  
BETA  
BMW  
GAS GAS  
HONDA  
HUSABERG  
HUSQVARNA  
KAWASAKI  
KTM  
MOTO TM  
RIEJU  
SHERCO  
SUZUKI  
YAMAHA

RM 85 2-Stroke Please Note: Nikasil Piston Size -Molycoated Skirt	<b>Piston Kit</b> 01.3122.A 01.3122.B 01.3122.C '02-23	<b>Size</b> 47.94 47.95 47.96	<b>Ring Set</b> 02.3122 02.3122 02.3122 '02-23	<b>CrankBearing &amp; Seal Kit</b> 23.CBS31099 '02-23	<b>Con. Rod Kit</b> 03.3122 '02-23	<b>Complete</b> 34.3122 '02-21				
			<b>Pin</b> 04.1441 '02-23	<b>Bearing</b> 23.6304C3 '02-23 2x	<b>S/E Bearing</b> 21.3103 '02-23	<b>Top-End</b> 35.3122 '02-23				
			<b>Clips</b> 05.1410C '02-23	<b>Oilseal Set</b> 42.3219 '02-23	<b>B/E Bearing</b> 22.202614F '02-23	<b>Head &amp; Base</b> 36.3191 '02-23				
					<b>Crankpin</b> 06.2045 '02-23	<b>Ignition Cover Gasket</b> 19.G93102 '02-23				

STREET  
APRILIA  
CAGIVA  
HONDA  
KAWASAKI  
KTM  
SUZUKI  
YAMAHA

RM 100 2-Stroke Please Note: Nikasil Piston Size	<b>Piston Kit</b> 01.4195.A 01.4195.B 01.4195.C '03	<b>Size</b> 52.45 52.46 52.47	<b>Ring Set</b> 02.4195 02.4195 02.4195 '03	<b>CrankBearing &amp; Seal Kit</b> 23.CBS41088 '03	<b>Con. Rod Kit</b> 03.4118 '03	<b>Top-End</b> 35.4198 '03				
				<b>Bearing</b> 23.6304C3 '03	<b>S/E Bearing</b> 21.4103 '03	<b>Head &amp; Base</b> 36.4198 '03				
				<b>Oilseal Set</b> 42.4105 '03	<b>B/E Bearing</b> 22.222916F '03	<b>Ignition Cover Gasket</b> 19.G94190 '03				
					<b>Crankpin</b> 06.2246 '03					

ATV-UTV  
CAN-AM  
GAS GAS  
HONDA  
KAWASAKI  
KTM  
POLARIS  
SUZUKI  
YAMAHA

PWC  
KAWASAKI  
POLARIS  
SEA DOO  
YAMAHA

SNOW  
ARCTIC CAT  
KAWASAKI  
LYNX  
MOTO-SKI  
POLARIS  
SKI DOO  
YAMAHA

MOPED & SCOOTER

MISC. TECH. SPECIAL

Footnotes: \* Bearings Only \*\* Rubbers included

<b>Air Filter</b> 52.31086 '02-23	<b>Basket</b> 17.3187F '02-23	<b>Complete Plate Set</b> 16.CPS31089 '02-23	<b>F/W Bearing</b> 23.S111072 '02-23	<b>Frontbrake Disc</b> 37.BD12193 '02-23	<b>Front Sprocket</b> 07.FS21093-13 07.FS21093-14 07.FS21093-15 '02-23	<b>Chain</b> 07.RC428130C '02-23 MX	<b>Swingarm</b> 26.210063 '02 26.210089 '03-23	<b>Seal &amp; Wiper</b> 40.S375011 '02-23
<b>Main Jet</b> 45.100-225 '02-23 Keihin	<b>Spring Kit</b> 17.CS31021 '02-23	<b>Friction Set</b> 16.S31003 '02-23	<b>R/W Bearing</b> 23.S111068 '02-23	<b>Rearbrake Disc</b> 37.BD23105 '02-23	<b>7075-T6 Alloy Rear Sprocket</b> 07.RA21093-47 07.RA21093-48 07.RA21093-49 07.RA21093-50 07.RA21093-51 07.RA21093-52 '02-23	<b>Lower Chain Roller</b> 33.0008 '02-23	<b>Oil Seal Set</b> 40.F375011 '02-23	
<b>Pilot Jet</b> 46.040-085 '02-23 Keihin	<b>Cover Gasket</b> 19.G3189 '02-23	<b>Steel Set</b> 16.S31089 '02-23	<b>Steering Bearing</b> 24.110006 '02-20	<b>Front Pad Set</b> 37.105202 '02-04 37.105202BX '02-04 Box of 10 37.106202 '05-23 37.106202BX '05-23 Box of 10	<b>7075-T6 Alloy Rear Sprocket</b> 07.RA21093-47 07.RA21093-48 07.RA21093-49 07.RA21093-50 07.RA21093-51 07.RA21093-52 '02-23	<b>Upper Chain Roller</b> 33.0008 '02-23	<b>Dust Seal Set</b> 40.F375011 '02-23	
<b>Carburetor Rebuild Kit</b> 55.10109 '05-19	<b>Clutch Cable</b> 53.120057 '02-23			<b>Rear Pad Set</b> 37.106002 '02-04 37.106002BX '02-04 Box of 10 37.204502 '05-23 37.204502BX '05-23 Box of 10	<b>Sprocket Bolt Set</b> 07.SBSM825 '02-23	<b>Lower</b> 26.450009 '02-03 26.450051 '04 26.450025 '05-23	<b>Bushing Set</b> 39.160112 '02-16	
<b>Throttle Cable</b> 53.111019 '02-23				<b>Front Caliper Rebuild Kit</b> 37.63013 '02-04 37.63025 '05-23		<b>Upper</b> 26.450018 '02-19	<b>Rear Shock Seal Head Kit</b> 26.810005 '02-04 26.810010 '05-19	
<b>Water Pump Rebuild Kit</b> 57.3122 '02-23				<b>Rear Caliper Rebuild Kit</b> 37.63037 '02-23				
				<b>Front Master Cylinder Rebuild Kit</b> 37.910016 '02-04 37.910002 '05-23				
				<b>Rear Master Cylinder Rebuild Kit</b> 37.910007 '02-23				
<b>Throttle Cable</b> 53.112003 '03	<b>Clutch Cable</b> 53.120056 '03	<b>Complete Plate Set</b> 16.CPS41098 '03	<b>F/W Bearing</b> 23.S111081 '03	<b>Front Pad Set</b> 37.106202 '03 37.106202BX '03 Box of 10	<b>Front Sprocket</b> 07.FS41086-12 07.FS41086-13 07.FS41086-14 07.FS41086-15 '03	<b>Chain</b> 07.RC420130C '03 MX	<b>Swingarm</b> 26.210067 '03	<b>Rear Shock Seal Head Kit</b> 26.810012 '03
<b>Water Pump Rebuild Kit</b> 57.4118 '03	<b>Spring Kit</b> 17.CS41013 '03	<b>Friction Set</b> 16.S41009 '03	<b>R/W Bearing</b> 23.S110033 '03	<b>Rear Pad Set</b> 37.200802 '03 37.200802BX '03 Box of 10	<b>7075-T6 Alloy Rear Sprocket</b> 07.RA41086-49 07.RA41086-50 07.RA41086-51 07.RA41086-52 07.RA41086-53 '03	<b>Lower Chain Roller</b> 33.0012 '03	<b>Linkage</b> 26.110014 '03	
		<b>Steel Set</b> 16.S41010 '03	<b>Steering Bearing</b> 24.110022 '03	<b>Front Caliper Rebuild Kit</b> 37.63025 '03		<b>Upper Chain Roller</b> 33.0012 '03	<b>Upper</b> 26.310002 '03	
				<b>Rear Caliper Rebuild Kit</b> 37.63033 '03			<b>Lower</b> 26.450022 '03	
				<b>Front Master Cylinder Rebuild Kit</b> 37.910002 '03				
				<b>Rear Master Cylinder Rebuild Kit</b> 37.910007 '03				

DIRT  
APRILIA  
BETA  
BMW  
GAS GAS  
HONDA  
HUSABERG  
HUSQVARNA  
KAWASAKI  
KTM  
MOTO TM  
RIEJU  
SHERCO  
SUZUKI  
YAMAHA

STREET  
APRILIA  
CAGIVA  
HONDA  
KAWASAKI  
KTM  
SUZUKI  
YAMAHA

ATV-UTV  
CAN-AM  
GAS GAS  
HONDA  
KAWASAKI  
KTM  
POLARIS  
SUZUKI  
YAMAHA

PWC  
KAWASAKI  
POLARIS  
SEA DOO  
YAMAHA

SNOW  
ARCTIC CAT  
KAWASAKI  
LYNX  
MOTO-SKI  
POLARIS  
SKI DOO  
YAMAHA

MOPED & SCOOTER

MISC. TECH. SPECIAL

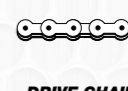

**SUZUKI**

**DIRT**  
APRILIA  
BETA  
BMW  
GAS GAS  
HONDA  
HUSABERG  
HUSQVARNA  
KAWASAKI  
KTM  
MOTO TM  
RIEJU  
SHERCO  
SUZUKI  
YAMAHA

TS 125 ER 2-Stroke	<b>Piston Kit</b> 01.3005.000 01.3005.025 01.3005.050 01.3005.075 01.3005.100 01.3005.125 01.3005.150 '78-87	<b>Size</b> 56.00 56.25 56.50 56.75 57.00 57.25 57.50	<b>Ring Set</b> - 02.3005.025 02.3005.050 02.3005.075 - 02.3005.125 02.3005.150 '78-87  <b>Clips</b> 05.1410G '78-87	<b>S/E Bearing</b> 21.3202					
TS 125 X 2-Stroke	<b>Piston Kit</b> 01.3005.000 01.3005.025 01.3005.050 01.3005.075 01.3005.100 01.3005.125 01.3005.150 '78-87	<b>Size</b> 56.00 56.25 56.50 56.75 57.00 57.25 57.50	<b>Ring Set</b> - 02.3005.025 02.3005.050 02.3005.075 - 02.3005.125 02.3005.150 '78-87  <b>Clips</b> 05.1410G '78-87	<b>Con. Rod Kit</b> 03.3006  <b>S/E Bearing</b> 21.3202  <b>B/E Bearing</b> 22.222816  <b>Crankpin</b> 06.2253					
TS 185 2-Stroke	<b>Piston Kit</b> -	<b>Size</b> 64.00	<b>Ring Set</b> -  <b>Clips</b> 05.1612G	<b>S/E Bearing</b> 21.2011  <b>B/E Bearing</b> 22.222816					

Footnotes: \* Bearings Only \*\* Rubbers included

									<b>Chain</b> 07.RC428130C '78-81 MX		
									<b>Chain</b> 07.RC428130C '78-81 MX		
									<b>Chain</b> 07.RC520120C '71-81 MX 07.RC520120CG '71-81 MX Gold 07.RC520120XC '71-81 X-Ring 07.RC520120XCG '71-81 X-Ring Gold		

**DIRT**  
APRILIA  
BETA  
BMW  
GAS GAS  
HONDA  
HUSABERG  
HUSQVARNA  
KAWASAKI  
KTM  
MOTO TM  
RIEJU  
SHERCO  
SUZUKI  
YAMAHA

**STREET**  
APRILIA  
CAGIVA  
HONDA  
KAWASAKI  
KTM  
SUZUKI  
YAMAHA

**ATV-UTV**  
CAN-AM  
GAS GAS  
HONDA  
KAWASAKI  
KTM  
POLARIS  
SUZUKI  
YAMAHA

**PWC**  
KAWASAKI  
POLARIS  
SEA DOO  
YAMAHA

**SNOW**  
ARCTIC CAT  
KAWASAKI  
LYNX  
MOTO-SKI  
POLARIS  
SKI DOO  
YAMAHA

**MOPED & SCOOTER**

**MISC. TECH. SPECIAL**



SUZUKI

DIRT  
APRILIA  
BETA  
BMW  
GAS GAS  
HONDA  
HUSABERG  
HUSQVARNA  
KAWASAKI  
KTM  
MOTO TM  
RIEJU  
SHERCO  
SUZUKI  
YAMAHA

Table with columns: RM 125, Piston Kit, Size, Ring Set, Crank Bearing & Seal Kit, Con. Rod Kit, Complete, Oilseal Set, B/E Bearing, Crankpin, Head & Base, Ignition Cover Gasket, Pin, Clips. Includes sub-sections for Piston Kits, Sizes, Ring Sets, Crank Bearings, Connecting Rods, Complete Kits, Oilseal Sets, B/E Bearings, Crankpins, and Head & Base components.

STREET  
APRILIA  
CAGIVA  
HONDA  
KAWASAKI  
KTM  
SUZUKI  
YAMAHA

ATV-UTV  
CAN-AM  
GAS GAS  
HONDA  
KAWASAKI  
KTM  
POLARIS  
SUZUKI  
YAMAHA

PWC  
KAWASAKI  
POLARIS  
SEA DOO  
YAMAHA

SNOW  
ARCTIC CAT  
KAWASAKI  
LYNX  
MOTO-SKI  
POLARIS  
SKI DOO  
YAMAHA

MOPED & SCOOTER

MISC. TECH. SPECIAL

Footnotes: \* Bearings Only \*\* Rubbers included

DIRT  
APRILIA  
BETA  
BMW  
GAS GAS  
HONDA  
HUSABERG  
HUSQVARNA  
KAWASAKI  
KTM  
MOTO TM  
RIEJU  
SHERCO  
SUZUKI  
YAMAHA

STREET  
APRILIA  
CAGIVA  
HONDA  
KAWASAKI  
KTM  
SUZUKI  
YAMAHA

ATV-UTV  
CAN-AM  
GAS GAS  
HONDA  
KAWASAKI  
KTM  
POLARIS  
SUZUKI  
YAMAHA

PWC  
KAWASAKI  
POLARIS  
SEA DOO  
YAMAHA

SNOW  
ARCTIC CAT  
KAWASAKI  
LYNX  
MOTO-SKI  
POLARIS  
SKI DOO  
YAMAHA

MOPED & SCOOTER

MISC. TECH. SPECIAL

Table with columns: Air Filter, Basket, Complete Plate Set, F/W Bearing, Frontbrake Disc, Front Sprocket, Chain, Swingarm, Seal & Wiper, Main Jet, Pressure Plate, Steel Set, R/W Bearing, Rear Pad Set, Ultralight Steel Rear Sprocket, Lower Chain, Roller, Sprocket Bolt Set, Carburetor Rebuild Kit, Cover Gasket, Clutch Cable, R/W Spacer Kit, Steering Bearing, Front Caliper Rebuild Kit, Rear Caliper Rebuild Kit, Front Master Cylinder Rebuild Kit, Throttle Cable, Water Pump Rebuild Kit, Rear Master Cylinder Rebuild Kit. Includes sub-sections for Air Filters, Baskets, Complete Plate Sets, F/W Bearings, Frontbrake Discs, Front Sprockets, Chains, Swingarms, Seal & Wiper Kits, Main Jets, Pressure Plates, Steel Sets, R/W Bearings, Rear Pad Sets, Ultralight Steel Rear Sprockets, Lower Chains, Rollers, Sprocket Bolt Sets, Carburetor Rebuild Kits, Cover Gaskets, Clutch Cables, R/W Spacers, Steering Bearings, Front Caliper Rebuild Kits, Rear Caliper Rebuild Kits, Front Master Cylinder Rebuild Kits, Throttle Cables, Water Pump Rebuild Kits, and Rear Master Cylinder Rebuild Kits.





**SUZUKI**

**DIRT**  
APRILIA  
BETA  
BMW  
GAS GAS  
HONDA  
HUSABERG  
HUSQVARNA  
KAWASAKI  
KTM  
MOTO TM  
RIEJU  
SHERCO  
SUZUKI  
YAMAHA

RMX 250  
2-Stroke  
Please Note:  
Nikasil Piston Size

**Piston Kit**  
01.3311.B  
01.3311.C  
01.3311.D  
'89-00

**Size**  
66.94  
66.95  
66.96

**Ring Set**  
02.3310 2x  
02.3310 2x  
02.3310 2x  
  
**Pin**  
04.1858  
'89-00  
  
**Clips**  
05.1812  
'89-00

**Con. Rod Kit**  
03.3310  
'89-00  
  
**S/E Bearing**  
21.3303  
'89-00  
  
**B/E Bearing**  
22.243020F  
'89-00  
  
**Crankpin**  
06.2458  
'89-00

**Top-End**  
35.3330  
'89-94  
35.3335  
'95-00  
  
**Ignition Cover Gasket**  
19.G93391  
'89-99

**Air Filter**  
52.32087  
'89-98  
  
**Carburetor Rebuild Kit**  
55.10541  
'89-92  
55.10540  
'93-99  
  
**Throttle Cable**  
53.111021  
'89-92  
53.111024  
'93-99  
  
**Water Pump Rebuild Kit**  
57.3311  
'90-99

**STREET**  
APRILIA  
CAGIVA  
HONDA  
KAWASAKI  
KTM  
SUZUKI  
YAMAHA

**ATV-UTV**  
CAN-AM  
GAS GAS  
HONDA  
KAWASAKI  
KTM  
POLARIS  
SUZUKI  
YAMAHA

**PWC**  
KAWASAKI  
POLARIS  
SEA DOO  
YAMAHA

**SNOW**  
ARCTIC CAT  
KAWASAKI  
LYNX  
MOTO-SKI  
POLARIS  
SKI DOO  
YAMAHA

**MOPED & SCOOTER**

**MISC. TECH. SPECIAL**

**DIRT**  
APRILIA  
BETA  
BMW  
GAS GAS  
HONDA  
HUSABERG  
HUSQVARNA  
KAWASAKI  
KTM  
MOTO TM  
RIEJU  
SHERCO  
SUZUKI  
YAMAHA

**STREET**  
APRILIA  
CAGIVA  
HONDA  
KAWASAKI  
KTM  
SUZUKI  
YAMAHA

**ATV-UTV**  
CAN-AM  
GAS GAS  
HONDA  
KAWASAKI  
KTM  
POLARIS  
SUZUKI  
YAMAHA

**PWC**  
KAWASAKI  
POLARIS  
SEA DOO  
YAMAHA

**SNOW**  
ARCTIC CAT  
KAWASAKI  
LYNX  
MOTO-SKI  
POLARIS  
SKI DOO  
YAMAHA

**MOPED & SCOOTER**

**MISC. TECH. SPECIAL**

**Air Filter**  
52.32087  
'89-98  
  
**Carburetor Rebuild Kit**  
55.10541  
'89-92  
55.10540  
'93-99  
  
**Throttle Cable**  
53.111021  
'89-92  
53.111024  
'93-99  
  
**Water Pump Rebuild Kit**  
57.3311  
'90-99

**Spring Kit**  
17.CS33023  
'89-00  
  
**Cover Gasket**  
19.G3391  
'89-99  
  
**Clutch Cable**  
53.120050  
'89  
53.120049  
'90-99

**F/W Bearing**  
23.S110051  
'89-90  
23.S110052  
'91-00  
  
**R/W Bearing**  
23.S112062  
'89-00  
  
**Steering Bearing**  
24.110024  
'89-90  
24.110001  
'91-92  
24.110013  
'93-00

**Frontbrake Disc**  
37.BD13288  
'95-00  
  
**Front Pad Set**  
37.100202  
'89-95  
37.100202BX  
'89-95 Box of 10  
37.103202  
'96-99  
37.103202BX  
'96-99 Box of 10

**Front Sprocket**  
07.FS33082-13  
07.FS33082-14  
07.FS33082-15  
'89-00  
  
**7075-T6 Alloy Rear Sprocket**  
07.RA32080-48  
07.RA32080-49  
07.RA32080-50  
07.RA32080-51  
07.RA32080-52  
'89-00

**Chain**  
07.RC520120C  
'89-00 MX  
07.RC520120CG  
'89-00 MX Gold  
07.RC520120XC  
'89-00 X-Ring  
07.RC520120XCG  
'89-00 X-Ring Gold  
  
**Countershaft Seal Kit**  
26.640027  
'89-00  
  
**Lower Chain Roller**  
33.0002  
'89-99  
  
**Upper Chain Roller**  
33.0002  
'89-99

**Swingarm**  
26.210045  
'89-00  
  
**Linkage**  
26.110075  
'89-90  
26.110136  
'91-00  
  
**Upper**  
26.350050  
'89-90  
26.310011  
'91-00  
  
**Lower**  
26.450033  
'89  
26.450009  
'90-91  
26.450011  
'92-00

**Seal & Wiper**  
40.S455711  
'91-00  
  
**Oil Seal Set**  
40.F455711P  
'91-00  
  
**Dust Seal Set**  
40.F4557DP  
'91-00  
  
**Bushing Set**  
39.160078  
'90  
39.160006  
'91  
39.160030  
'92-99  
  
**Rear Shock Seal Head Kit**  
26.810007  
'89-90  
26.810008  
'91-99

**Sprocket Bolt Set**  
07.SBSM825  
'89-00

Footnotes: \* Bearings Only \*\* Rubbers included



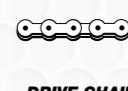

### SUZUKI

#### DIRT

- APRILIA
- BETA
- BMW
- GAS GAS
- HONDA
- HUSABERG
- HUSQVARNA
- KAWASAKI
- KTM
- MOTO TM
- RIEJU
- SHERCO
- SUZUKI
- YAMAHA

RM-Z 250 4-Stroke Please Note: Nikasil Piston Size -Std. Compression 12.6:1 -Forged Piston	Piston Kit 01.4335.A 01.4335.B 01.4335.C '04-06	Size 76.96 76.97 76.98	Ring Set 02.4334 02.4334 02.4334 '04-06	Crankshaft 10.3337 '07-09	Con. Rod Kit 03.4334 '04-23	Complete 34.4334 '04-06 34.3337 '07-09 34.3341 '10-15 34.3336 '16	Cam Chain 31.2402 '04-23	Valve 28.4334-1 '04-06 2x Exhaust Titanium 28.4334-2 '04-06 2x Intake Titanium 28.3337-1 '07-23 2x Exhaust Titanium 28.3337-2 '07-09 2x Intake Titanium 28.3340-2 '10-23 2x Intake Titanium
Please Note: Nikasil Piston Size -Std. Compression 13.4:1 -Forged Piston	01.3338.A 01.3338.B 01.3338.C '07-09	76.96 76.97 76.98	02.3337 02.3337 02.3337 '07-09	<b>Crank Bearing &amp; Seal Kit</b> 23.CBS43004 '04-06	<b>B/E Bearing</b> 22.303818F '04-23	<b>Valve Shim Assortment</b> 29.VSA748 '04-23	<b>Valve Shim Assortment</b> 29.VSA748-2 '04-23	<b>Top-End</b> 35.4334 '04-06 35.3337 '07-09 35.3341 '10-18 35.3349 '19-23
	01.3341.A 01.3341.B 01.3341.C '10-23	76.96 76.97 76.98	02.3337 02.3337 02.3337 '10-23	<b>Bearing</b> 23.6206RSI '04-06 2x 23.830046-14 '07-09 2x 23.830046-20 '10-23 2x	<b>Head &amp; Base</b> 36.4304 '04-06 36.3307 '07-09 36.3310 '10-23	<b>Ignition Cover Gasket</b> 19.G94304 '04-06 19.G93337 '07-09 19.G93340 '10-16	<b>TI-Steel Conversion Set</b> 28.SES4335-1 '04-06 Exhaust 28.SIS4335-2 '04-06 Intake 28.SES3338-1 '07-23 Exhaust 28.SIS3338-2 '07-23 Intake	<b>Valve Seal</b> 35.VS021 '04-06 2x Intake 35.VS021 '04-06 2x Exhaust 35.VS018 '07-23 2x Intake 35.VS018 '07-23 2x Exhaust
Please Note: Nikasil Piston Size -Std. Comp. 13.75:1 from 2019 -Forged Piston -Fuel Injection	01.3341.A 01.3341.B 01.3341.C '10-23	76.96 76.97 76.98	02.3337 02.3337 02.3337 '10-23	<b>Oilseal</b> 41.4-0030 '04-06 1x 41.3-30061 '07-09 1x 42.3340 '10-23	<b>Pin</b> 04.1645 '04-06 04.1637.9 '10-23	<b>Clips</b> 05.1612C '04-23	<b>TI-Steel Conversion Set</b> 28.SES4335-1 '04-06 Exhaust 28.SIS4335-2 '04-06 Intake 28.SES3338-1 '07-23 Exhaust 28.SIS3338-2 '07-23 Intake	<b>Valve Seal</b> 35.VS021 '04-06 2x Intake 35.VS021 '04-06 2x Exhaust 35.VS018 '07-23 2x Intake 35.VS018 '07-23 2x Exhaust

Footnotes: \* Bearings Only \*\* Rubbers included

#### STREET

- APRILIA
- CAGIVA
- HONDA
- KAWASAKI
- KTM
- SUZUKI
- YAMAHA

#### ATV-UTV

- CAN-AM
- GAS GAS
- HONDA
- KAWASAKI
- KTM
- POLARIS
- SUZUKI
- YAMAHA

#### PWC

- KAWASAKI
- POLARIS
- SEA DOO
- YAMAHA

#### SNOW

- ARCTIC CAT
- KAWASAKI
- LYNX
- MOTO-SKI
- POLARIS
- SKI DOO
- YAMAHA

#### MOPED & SCOOTER

#### MISC. TECH. SPECIAL

#### DIRT

- APRILIA
- BETA
- BMW
- GAS GAS
- HONDA
- HUSABERG
- HUSQVARNA
- KAWASAKI
- KTM
- MOTO TM
- RIEJU
- SHERCO
- SUZUKI
- YAMAHA

#### STREET

- APRILIA
- CAGIVA
- HONDA
- KAWASAKI
- KTM
- SUZUKI
- YAMAHA

#### ATV-UTV

- CAN-AM
- GAS GAS
- HONDA
- KAWASAKI
- KTM
- POLARIS
- SUZUKI
- YAMAHA

#### PWC

- KAWASAKI
- POLARIS
- SEA DOO
- YAMAHA

#### SNOW

- ARCTIC CAT
- KAWASAKI
- LYNX
- MOTO-SKI
- POLARIS
- SKI DOO
- YAMAHA

#### MOPED & SCOOTER

#### MISC. TECH. SPECIAL

Air Filter 52.33004 '04-06 52.32004 '07-18 52.34018 '19-23	Basket 17.4334F * '04-05 17.4336F * '06 17.3338F * '07-23	Complete Plate Set 16.CPS43004 '04 16.CPS43005 '05-06 16.CPS33007 '07-09 16.CPS33010 '10 16.CPS33011 '11-23	F/W Bearing 23.S110079 '04-06 23.S114082 '07-20	Frontbrake Disc 37.BD13307 '07-18 37.BD13418 '19-23	Front Sprocket 07.FS43004-12 07.FS43004-13 07.FS43004-14 07.FS43004-15 '04-06 07.FS32080-12 07.FS32080-13 07.FS32080-14 '07-12 07.FS33014-12 07.FS33014-13 07.FS33014-14 '13-23	Chain 07.RC520120C '04-23 MX 07.RC520120CG '04-23 MX Gold 07.RC520120XC '04-23 X-Ring 07.RC520120XCG '04-23 X-Ring Gold	Swingarm 26.210115 '04-06 26.210047 '07-23	Seal & Wiper 40.S485810 '04-06 40.S475810 '07-12 40.S485810 '13-15 40.S48589.4 '16-23
<b>Main Jet</b> 45.100-225 '04-09 Keihin	<b>Clutch Rubber Set</b> 17.CRS2288-8 '04-05 17.CRS4336-8 '06 17.CRS3386-8 '07-23	<b>Friction Set</b> 16.S43024 '04 16.S43026 '05-06 16.S33028 '07-10 16.S33032 '11-23	<b>F/W Spacer Kit</b> 26.710029 '04-06 26.710058 '07-23	<b>Rearbrake Disc</b> 37.BD24203 '04-06 37.BD23307 '07-23	<b>Front Pad Set</b> 37.103202 '04-23 37.103202BX '04-23 Box of 10	<b>Countershaft Seal Kit</b> 26.640013 '04-06 26.640026 '07-12 26.640028 '13-23	<b>Linkage</b> 26.110117 '04-06 26.110127 '07-09 26.110179 '10-12 26.110181 '13-18	<b>Oil Seal Set</b> 40.F475810 '04-06 40.F485810 '07-12 40.F485810 '13-15 40.F48589.4 '16-23
<b>Pilot Jet</b> 46.040-085 '04-09 Keihin	<b>Inner Hub</b> 18.4334 '04-06 18.3337 '07-10 18.3341 '11-23	<b>Steel Set</b> 16.S43025 '04-23	<b>R/W Spacer Kit</b> 26.710042 '04-06 26.710051 '07-23	<b>Rear Pad Set</b> 37.201302 '04-23 37.201302BX '04-23 Box of 10	<b>Front Caliper Rebuild Kit</b> 37.63005 '04-23	<b>7075-T6 Alloy Rear Sprocket</b> 07.RA42080-47 07.RA42080-48 07.RA42080-49 07.RA42080-50 07.RA42080-51 07.RA42080-52 '04-06	<b>Upper</b> 26.310002 '04-06 26.310003 '07-23	<b>Dust Seal Set</b> 40.F4858D '04-06 40.F4758D '07-12 40.F4858D '13-23
<b>Carburetor Rebuild Kit</b> 55.10490 '04-06 55.10491 '07 55.10492 '08-09	<b>Pressure Plate</b> 18.P4303 '04-06 18.P3337 '07-23	<b>Spring Kit</b> 17.CS42015 '04 17.CS43017 '05-06 17.CS33026 '07-09 17.CS33052 '10-23	<b>Steering Bearing</b> 24.110023 '04-06 24.110013 '07 24.110058 '08-20	<b>Rear Caliper Rebuild Kit</b> 37.63032 '04-07 37.63036 '08-23	<b>Front Master Cylinder Rebuild Kit</b> 37.910002 '04-23	<b>UltraLight Steel Rear Sprocket</b> 07.RS42080R-47 07.RS42080R-48 07.RS42080R-49 07.RS42080R-50 07.RS42080R-51 07.RS42080R-52 '04-06	<b>Lower Chain Roller</b> 33.0001 '04-15 33.0001 '04-23	<b>Bushing Set</b> 39.160036 '04-06 39.160015 '07-12 39.160108 '13-15
<b>Oil Filter</b> 54.43207 '04-23 1-Pcc. 54.43207-50 '04-23 50-Pcs.	<b>Cover Gasket</b> 19.G4334 '04-06 19.G3337 '07-23	<b>Water Pump Rebuild Kit</b> 57.4324 '04-06 57.3327 '07-15	<b>Rear Master Cylinder Rebuild Kit</b> 37.910007 '04-06 37.910009 '07-23	<b>Sprocket Bolt Set</b> 07.SBSM825 '04-23	<b>Rear Shock Seal Head Kit</b> 26.810004 '04-06 26.810125 '07-16			





SUZUKI

DIRT  
APRILIA  
BETA  
BMW  
GAS GAS  
HONDA  
HUSABERG  
HUSQVARNA  
KAWASAKI  
KTM  
MOTO TM  
RIEJU  
SHERCO  
SUZUKI  
YAMAHA

DR 350 4-Stroke -Std. Compression 9.5:1	Piston Kit -	Size 79.00	Ring Set -	CrankBearing & Seal Kit 23.CBS33090* '90-99  Bearing 23.6207C3 '90-99 Left 23.6306C3 '90-99 Right		Top-End 35.3390 '90-99	Cam.Chain 31.3390 '90-99	Valve Seal 35.VS019 '90-99 2x Intake 35.VS019 '90-99 2x Exhaust
---	-----------------	---------------	---------------	---	--	------------------------------	--------------------------------	---

STREET  
APRILIA  
CAGIVA  
HONDA  
KAWASAKI  
KTM  
SUZUKI  
YAMAHA

DR-Z 400 4-Stroke Please Note: Nikasil Piston Size -Std. Compression 12.2:1 -Forged Piston	Piston Kit 01.3420.A 01.3420.B 01.3420.C '00-23	Size 89.96 89.97 89.98	Ring Set 02.3402 02.3402 02.3402 '00-23  Clips 05.2012 '00-23	CrankBearing & Seal Kit 23.CBS34000* '00-23  Bearing 23.6306R/3 '00-23 2x	Con. Rod Kit 03.3402 '00-23  B/E Bearing 22.354322F '00-23	Complete 34.3420 '00-23  Top-End 35.3420 '00-23  Ignition Cover Gasket 19.G93400 '00-23	Cam.Chain 31.3403 '00-23  Valve Shim Assortment 29.VSA948 '00-23 29.VSA948-2 '00-23	Valve 28.3402-1 '00-23 2x Exhaust Steel 28.3402-2 '00-23 2x Intake Steel  Valve Seal 35.VS019 '00-23 2x Intake 35.VS019 '00-23 2x Exhaust
---	---	---------------------------------	---	---	--	--	--	---

PWC  
KAWASAKI  
POLARIS  
SEA DOO  
YAMAHA

--	--	--	--	--	--	--	--	--

SNOW  
ARCTIC CAT  
KAWASAKI  
LYNX  
MOTO-SKI  
POLARIS  
SKI DOO  
YAMAHA

--	--	--	--	--	--	--	--	--

MOPED & SCOOTER

--	--	--	--	--	--	--	--	--

MISC. TECH. SPECIAL

Footnotes: \* Bearings Only \*\* Rubbers included

Air Filter 52.33090 '90-99  Throttle Cable 53.112012 '90-99	Clutch Cable 53.120044 '90-94 53.120043 '95-96 53.120044 '97-99	Friction Set 16.S33033 '90-99  Steel Set 16.S33090 '90-99	F/W Bearing 23.S111088 '90-96 23.S110052 '97-99  Steering Bearing 24.110004 '90-99	Front Pad Set 37.100202 '90-99 37.100202BX '90-99 Box of 10  Rear Pad Set 37.201202 '90-99 37.201202BX '90-99 Box of 10  Front Caliper Rebuild Kit 37.63010 '90-96 37.63005 '97-99  Rear Caliper Rebuild Kit 37.63004 '90-99 37.63031 '90-99 SE  Front Master Cylinder Rebuild Kit 37.910016 '90-99 37.910004 '90-98 SE 37.910002 '99 SE  Rear Master Cylinder Rebuild Kit 37.910007 '90-99	Front Sprocket 07.FS33082-13 07.FS33082-14 07.FS33082-15 '90-99  7075-T6 Alloy Rear Sprocket 07.RA32080-48 07.RA32080-49 07.RA32080-50 07.RA32080-51 07.RA32080-52 '90-99  Ultralight Steel Rear Sprocket 07.RS32080R-48 07.RS32080R-49 07.RS32080R-50 07.RS32080R-51 07.RS32080R-52 '90-99  Sprocket Bolt Set 07.SBSM825 '90-99	Chain 07.RC520120C '90-99 MX 07.RC520120CG '90-99 MX Gold 07.RC520120XC '90-99 X-Ring 07.RC520120XCG '90-99 X-Ring Gold  Lower Chain Roller 33.0002 '90-99  Upper Chain Roller 33.0002 '90-99 33.0008 '97-99 SE	Swingarm 26.210105 '90-99  Linkage 26.110061 '90-99  Lower 26.450033 '90-99  Dust Seal Set 40.F435411 '90-99	Seal & Wiper 40.S435411 '90-99  Oil Seal Set 40.F435411 '90-99  Bushing Set 39.160033 '97-99  Dust Seal Set 40.F4354DP '90-99
Air Filter 52.34000 '00-23  Throttle Cable 53.111083 '00-07 E FCR39 '00-03 K 53.111084 '04-07 E BSR36 '00-23 S '05-17 SM  Oil Filter 54.34139 '00-23 1-Pce. 54.34139-50 '00-23 50-Pcs.  Water Pump Rebuild Kit 57.3420 '00-23	Basket 17.3400F '00-23  Pressure Plate 18.P3402 '00-23  Spring Kit 17.CS44019 '00-23  Cover Gasket 19.G3401 '00-23  Clutch Cable 53.120042 '00-23	Complete Plate Set 16.CPS34000 '00-23  Friction Set 16.S34015 '00-23  Steel Set 16.S34016 '00-23	F/W Bearing 23.S110079 '00-16  R/W Bearing 23.S111017 '00-16  F/W Spacer Kit 26.710057 '00-16  R/W Spacer Kit 26.710048 '00-16  Steering Bearing 24.110013 '00-23	Frontbrake Disc 37.BD13288 '00-07  Front Pad Set 37.103202 '00-13 37.103202BX '00-13 Box of 10  Rear Pad Set 37.207102 '00-23 37.207102BX '00-23 Box of 10  Front Caliper Rebuild Kit 37.63005 '00-16  Rear Caliper Rebuild Kit 37.63028 '00-16 37.63030 '00-16 SM  Front Master Cylinder Rebuild Kit 37.910002 '00-06 E 37.910004 '07 E 37.910004 '00-16 S 37.910004 '05-16 SM  Rear Master Cylinder Rebuild Kit 37.910007 '00-16	Front Sprocket 07.FS33082-13 07.FS33082-14 07.FS33082-15 '00-23  7075-T6 Alloy Rear Sprocket 07.RA32080-48 07.RA32080-49 07.RA32080-50 07.RA32080-51 07.RA32080-52 '00-23  Ultralight Steel Rear Sprocket 07.RS32080R-48 07.RS32080R-49 07.RS32080R-50 07.RS32080R-51 07.RS32080R-52 '00-23  Sprocket Bolt Set 07.SBSM825 '00-23	Chain 07.RC520120C '00-23 MX 07.RC520120CG '00-23 MX Gold 07.RC520120XC '00-23 X-Ring 07.RC520120XCG '00-23 X-Ring Gold  Countershaft Seal Kit 26.640025 '00-23  Lower Chain Roller 33.0002 '00-23  Upper Chain Roller 33.0001 '00-23	Swingarm 26.210047 '00-23  Linkage 26.110043 '00-23  Upper 26.350054 '00-23  Lower 26.450024 '00-23  Rear Shock Seal Head Kit 26.810001 '00-16	Seal & Wiper 40.S496011 '00-13  Oil Seal Set 40.F496011 '00-13  Dust Seal Set 40.F4960D '00-13  Bushing Set 39.160037 '00-16 39.160037 '00-16  Rear Shock Seal Head Kit 26.810001 '00-16

DIRT  
APRILIA  
BETA  
BMW  
GAS GAS  
HONDA  
HUSABERG  
HUSQVARNA  
KAWASAKI  
KTM  
MOTO TM  
RIEJU  
SHERCO  
SUZUKI  
YAMAHA

STREET  
APRILIA  
CAGIVA  
HONDA  
KAWASAKI  
KTM  
SUZUKI  
YAMAHA

ATV-UTV  
CAN-AM  
GAS GAS  
HONDA  
KAWASAKI  
KTM  
POLARIS  
SUZUKI  
YAMAHA

PWC  
KAWASAKI  
POLARIS  
SEA DOO  
YAMAHA

SNOW  
ARCTIC CAT  
KAWASAKI  
LYNX  
MOTO-SKI  
POLARIS  
SKI DOO  
YAMAHA

MOPED & SCOOTER

MISC. TECH. SPECIAL



SUZUKI

DIRT  
APRILIA  
BETA  
BMW  
GAS GAS  
HONDA  
HUSABERG  
HUSQVARNA  
KAWASAKI  
KTM  
MOTO TM  
RIEJU  
SHERCO  
SUZUKI  
YAMAHA

Table with columns: Part Name, Piston Kit, Size, Ring Set, Crankshaft, Con. Rod Kit, Complete, Cam Chain, Valve, etc. for Suzuki models.

STREET  
APRILIA  
CAGIVA  
HONDA  
KAWASAKI  
KTM  
SUZUKI  
YAMAHA

Table with columns: Part Name, High Compression, Size, Ring Set, etc. for Suzuki Street models.

ATV-UTV  
CAN-AM  
GAS GAS  
HONDA  
KAWASAKI  
KTM  
POLARIS  
SUZUKI  
YAMAHA

Table with columns: Part Name, Pin, Clips, etc. for Suzuki ATV-UTV models.

PWC  
KAWASAKI  
POLARIS  
SEA DOO  
YAMAHA

Table with columns: Part Name, Piston Kit, Size, Ring Set, Crankshaft, Con. Rod Kit, Top-End, Cam Chain, Valve, etc. for Suzuki PWC models.

SNOW  
ARCTIC CAT  
KAWASAKI  
LYNX  
MOTO-SKI  
POLARIS  
SKI DOO  
YAMAHA

Table with columns: Part Name, High Comp., Size, Ring Set, Crankshaft, Con. Rod Kit, Head & Base, Valve Shim Assortment, TI-Steel Conversion Set, Valve Seal, etc. for Suzuki Snow models.

MOPED & SCOOTER

MISC. TECH. SPECIAL

Footnotes: \* Bearings Only \*\* Rubbers included

DIRT  
APRILIA  
BETA  
BMW  
GAS GAS  
HONDA  
HUSABERG  
HUSQVARNA  
KAWASAKI  
KTM  
MOTO TM  
RIEJU  
SHERCO  
SUZUKI  
YAMAHA

STREET  
APRILIA  
CAGIVA  
HONDA  
KAWASAKI  
KTM  
SUZUKI  
YAMAHA

ATV-UTV  
CAN-AM  
GAS GAS  
HONDA  
KAWASAKI  
KTM  
POLARIS  
SUZUKI  
YAMAHA

PWC  
KAWASAKI  
POLARIS  
SEA DOO  
YAMAHA

SNOW  
ARCTIC CAT  
KAWASAKI  
LYNX  
MOTO-SKI  
POLARIS  
SKI DOO  
YAMAHA

MOPED & SCOOTER

MISC. TECH. SPECIAL

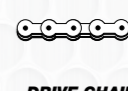

### SUZUKI

**DIRT**  
APRILIA  
BETA  
BMW  
GAS GAS  
HONDA  
HUSABERG  
HUSQVARNA  
KAWASAKI  
KTM  
MOTO TM  
RIEJU  
SHERCO  
SUZUKI  
YAMAHA

DR 650 SE 4-Stroke Please Note: Nikasil Piston Size -Std. Compression 9.5:1	<b>Piston Kit</b> -	<b>Size</b> 100.00	<b>Ring Set</b> -			<b>Ignition Cover Gasket</b> 19.G93690 '90-22	<b>Cam Chain</b> 31.2669 '96-22	<b>Valve Seal</b> 35.VS020 '96-22 2x Intake 35.VS020 '96-22 2x Exhaust
---	------------------------	-----------------------	----------------------	--	--	---	---------------------------------------	--

### YAMAHA

**STREET**  
APRILIA  
CAGIVA  
HONDA  
KAWASAKI  
KTM  
SUZUKI  
YAMAHA

PW 50 2-Stroke	<b>Piston Kit</b> 01.2005.000 01.2005.050 01.2005.075 01.2005.100 '81-23	<b>Size</b> 40.00 40.50 40.75 41.00	<b>Ring Set</b> - 02.2003.075 - '81-23  <b>Pin</b> 04.1033 '81-23  <b>Clips</b> 05.1010G '81-23	<b>Crank Bearing &amp; Seal Kit</b> 23.CBS21081 '81-23  <b>Bearing</b> 23.6203C3 '81-23  <b>Oilseal Set</b> 42.2005 '81-23	<b>Con. Rod Kit</b> 03.2008 '81-23  <b>S/E Bearing</b> 21.1000 '81-23	<b>Complete</b> 34.2090 '90-23  <b>Top-End</b> 35.2005 '90-23		
-------------------	---	---	---	--	---	---	--	--

**ATV-UTV**  
CAN-AM  
GAS GAS  
HONDA  
KAWASAKI  
KTM  
POLARIS  
SUZUKI  
YAMAHA

YZ 65 2-Stroke Please Note: Nikasil Piston Size	<b>Piston Kit</b> 01.2018.A 01.2018.B 01.2018.C '18-23	<b>Size</b> 43.44 43.45 43.46	<b>Ring Set</b> 02.2018 02.2018 02.2018 '18-23	<b>Crank Bearing &amp; Seal Kit</b> 23.CBS20018 '18-23  <b>Bearing</b> 23.6304SH '18-23 Right 23.83299SH '18-23 Left  <b>Oilseal Set</b> 42.2018 '18-23	<b>Con. Rod Kit</b> 03.2018 '18-23  <b>S/E Bearing</b> 21.2018 '18-23  <b>B/E Bearing</b> 22.182414F '18-23  <b>Crankpin</b> 06.1843.3 '18-23  <b>Washers</b> 03W.18311.0 '18-23	<b>Top-End</b> 35.2018 '18-23  <b>Head &amp; Base</b> 36.2018 '18-23  <b>Ignition Cover Gasket</b> 19.G92102 '18-23		
--	--	--	--	---	--	---	--	--

**PWC**  
KAWASAKI  
POLARIS  
SEA DOO  
YAMAHA

**SNOW**  
ARCTIC CAT  
KAWASAKI  
LYNX  
MOTO-SKI  
POLARIS  
SKI DOO  
YAMAHA

**MOPED & SCOOTER**

PW 80 2-Stroke	<b>Piston Kit</b> 01.2008.000 01.2008.050 01.2008.100 '83-06	<b>Size</b> 47.00 47.50 48.00	<b>Ring Set</b> 02.2008.000 02.2008.050 02.2008.100 '83-06  <b>Clips</b> 05.1210G '83-06	<b>Crank Bearing &amp; Seal Kit</b> 23.CBS21083 '83-06  <b>Bearing</b> 23.6205C3 '83-06 2x  <b>Oilseal Set</b> 42.2008 '83-06	<b>Con. Rod Kit</b> 03.2007 '83-06  <b>S/E Bearing</b> 21.2001 '83-06  <b>Crankpin</b> 06.2046 '83-06	<b>Top-End</b> 35.2008 '83-06		
-------------------	--	--	--	---	---	-------------------------------------	--	--

Footnotes: \* Bearings Only \*\* Rubbers included

**DIRT**  
APRILIA  
BETA  
BMW  
GAS GAS  
HONDA  
HUSABERG  
HUSQVARNA  
KAWASAKI  
KTM  
MOTO TM  
RIEJU  
SHERCO  
SUZUKI  
YAMAHA

**STREET**  
APRILIA  
CAGIVA  
HONDA  
KAWASAKI  
KTM  
SUZUKI  
YAMAHA

**ATV-UTV**  
CAN-AM  
GAS GAS  
HONDA  
KAWASAKI  
KTM  
POLARIS  
SUZUKI  
YAMAHA

**PWC**  
KAWASAKI  
POLARIS  
SEA DOO  
YAMAHA

**SNOW**  
ARCTIC CAT  
KAWASAKI  
LYNX  
MOTO-SKI  
POLARIS  
SKI DOO  
YAMAHA

**MOPED & SCOOTER**

**MISC. TECH. SPECIAL**

<b>Air Filter</b> 52.36096 '96-22	<b>Clutch Cable</b> 53.120039 '96-22		<b>F/W Bearing</b> 23.S110051 '06-22	<b>Front Pad Set</b> 37.103202 '96-22 37.103202BX '96-22 Box of 10		<b>Lower Chain Roller</b> 33.0001 '96-22	<b>Swingarm</b> 26.210105 '96-22	<b>Bushing Set</b> 39.160039 '96-22
<b>Throttle Cable</b> 53.111073 '92-95 53.111085 '96-22			<b>Steering Bearing</b> 24.110013 '96-22	<b>Front Caliper Rebuild Kit</b> 37.63005 '96-22  <b>Rear Caliper Rebuild Kit</b> 37.63035 '96-22  <b>Front Master Cylinder Rebuild Kit</b> 37.910004 '96-22  <b>Rear Master Cylinder Rebuild Kit</b> 37.910007 '96-22		<b>Upper Chain Roller</b> 33.0001 '96-22	<b>Linkage</b> 26.110104 '96-19	<b>Lower</b> 26.450020 '96-19

<b>Air Filter</b> 52.20092 '92-23			<b>F/W Bearing</b> 23.S111059 '81-23					
<b>Throttle Cable</b> 53.112010 '82-02 53.110062 '03-23			<b>R/W Bearing</b> 23.S115005 '81-23					
			<b>Steering Bearing</b> 24.110064 '81-20					

<b>Air Filter</b> 52.20018 '18-23	<b>Basket</b> 17.2196F '18-21	<b>Complete Plate Set</b> 16.CPS20018 '18-23	<b>F/W Bearing</b> 23.S117036 '18-23	<b>Frontbrake Disc</b> 37.BD12018 '18-23	<b>Front Sprocket</b> 07.FS20018-13 07.FS20018-14 07.FS20018-15 '18-23	<b>Chain</b> 07.RC420130C '18-23 MX	<b>Swingarm</b> 26.210061 '18-23	<b>Seal &amp; Wiper</b> 40.S36488P '18-23
<b>Main Jet</b> 45.100-225 '18-23 Keihin	<b>Spring Kit</b> 17.CS21029 '18-23	<b>Friction Set</b> 16.S20018 '18-23	<b>R/W Bearing</b> 23.S111068 '18-23	<b>Rearbrake Disc</b> 37.BD22193 '18-23	<b>7075-T6 Alloy Rear Sprocket</b> 07.RA20018-46 07.RA20018-47 07.RA20018-48 07.RA20018-49 '18-23	<b>Countershaft Seal Kit</b> 26.640024 '18-23		<b>Oil Seal Set</b> 40.F36488P '18-23
<b>Pilot Jet</b> 46.040-085 '18-23 Keihin	<b>Clutch Cable</b> 53.121050 '18-23	<b>Steel Set</b> 16.S20019 '18-23	<b>R/W Spacer Kit</b> 26.710076 '18-23	<b>Front Pad Set</b> 37.104102 '18-23 37.104102BX '18-23 Box of 10		<b>Upper Chain Roller</b> 33.0009 '18-23		<b>Dust Seal Set</b> 40.F3648DP '18-23
<b>Throttle Cable</b> 53.112077 '18-23			<b>Steering Bearing</b> 24.110022 '18-23	<b>Rear Pad Set</b> 37.200802 '18-23 37.200802BX '18-23 Box of 10	<b>Sprocket Bolt Set</b> 07.SBSM825 '18-23			<b>Rear Shock Seal Head Kit</b> 26.810012 '18-20
				<b>Front Caliper Rebuild Kit</b> 37.63014 '18-23 <b>Front Master Cylinder Rebuild Kit</b> 37.910002 '18-23				

<b>Air Filter</b> 52.20091 '91-06			<b>F/W Bearing</b> 23.S111061 '83-06		<b>Front Sprocket</b> 07.FS41086-12 07.FS41086-13 07.FS41086-14 07.FS41086-15 '83-06	<b>Chain</b> 07.RC420130C '83-06 MX		
			<b>R/W Bearing</b> 23.S110095 '83-06					
			<b>Steering Bearing</b> 24.110008 '83-06					



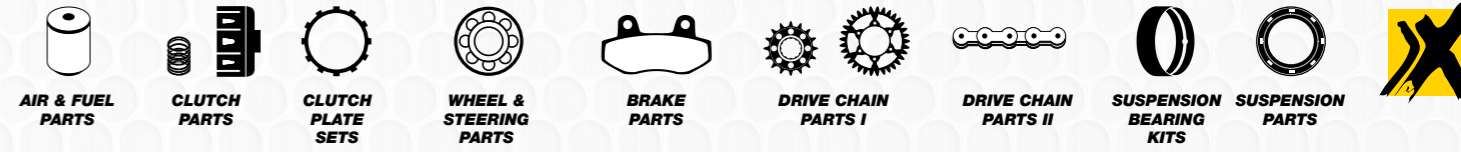

### YAMAHA

<b>DIRT</b> APRILIA BETA BMW GAS GAS HONDA HUSABERG HUSQVARNA KAWASAKI KTM MOTO TM RIEJU SHERCO SUZUKI YAMAHA	YZ 80 International Bore 79cc 2-Stroke Please Note: Nikasil Piston Size -Molycoated Skirt	<b>Piston Kit</b> 01.2107.B 01.2107.C 01.2107.D '93-01	<b>Size</b> 45.94 45.95 45.96	<b>Ring Set</b> 02.2107 02.2107 02.2107 '93-01	<b>CrankBearing &amp; Seal Kit</b> 23.CBS21082 '82-92 23.CBS21093 '93-01	<b>Con. Rod Kit</b> 03.2105 '93-01	<b>Complete</b> 34.2106 '86-92 34.2113 '93-01		
	USA Bore 82cc Please Note: Nikasil Piston Size -Molycoated Skirt	01.2109.B 01.2109.C 01.2109.D '93-01	46.94 46.95 46.96	02.2103.000 02.2103.000 02.2103.000 '93-01	<b>Bearing</b> 23.6204C3 '80-92 2x '93-01 Left 23.6304C3 '93-01 Right	<b>S/E Bearing</b> 21.2103 '82-92 21.1111 '93-01	<b>Top-End</b> 35.2106 '86-92 35.2113 '93-01	<b>Head &amp; Base</b> 36.2102 '93-01	<b>Ignition Cover Gasket</b> 19.G92193 '93-01
				<b>Pin</b> 04.1439 '93-01	<b>Oilseal Set</b> 42.2102 '82-01	<b>Crankpin</b> 06.1843.5 '82-83 + '86-92			
				<b>Clips</b> 05.1210C '82-87 05.1410C '93-01					
<b>STREET</b> APRILIA CAGIVA HONDA KAWASAKI KTM SUZUKI YAMAHA									
<b>ATV-UTV</b> CAN-AM GAS GAS HONDA KAWASAKI KTM POLARIS SUZUKI YAMAHA	YZ 85 2-Stroke Please Note: Nikasil Piston Size -Molycoated Skirt	<b>Piston Kit</b> 01.2114.A 01.2114.B 01.2114.C '02-23	<b>Size</b> 47.44 47.45 47.46	<b>Ring Set</b> 02.2113 02.2113 02.2113 '02-23	<b>CrankBearing &amp; Seal Kit</b> 23.CBS21093 '02-18 23.CBS20018 '19-23	<b>Con. Rod Kit</b> 03.2105 '02-18 03.2119 '19-23	<b>Complete</b> 34.2122 '02-18	<b>Top-End</b> 35.2122 '02-18 35.2129 '19-23	<b>Head &amp; Base</b> 36.2102 '02-18 36.2119 '19-23
				<b>Pin</b> 04.1439 '02-23	<b>Bearing</b> 23.6204C3 '02-18 Left 23.83299SH '19-23 Left 23.6304C3 '02-18 Right 23.6304SH '19-23 Right	<b>S/E Bearing</b> 21.1111 '02-23	<b>Head &amp; Base</b> 36.2102 '02-18 36.2119 '19-23	<b>Ignition Cover Gasket</b> 19.G92102 '02-23	
				<b>Clips</b> 05.1410C '02-23	<b>Oilseal Set</b> 42.2102 '02-18 42.2018 '19-23	<b>Washers</b> 03W.20331.0 '02-23 2x			
<b>PWC</b> KAWASAKI POLARIS SEA DOO YAMAHA									
<b>SNOW</b> ARCTIC CAT KAWASAKI LYNX MOTO-SKI POLARIS SKI DOO YAMAHA									
<b>MOPED &amp; SCOOTER</b>	TT-R 125 4-Stroke	<b>Piston Kit</b> -	<b>Size</b> 54.00	<b>Ring Set</b> -			<b>Complete</b> 34.2200 '00-07	<b>Top-End</b> 35.2201 '00-07	<b>Ignition Cover Gasket</b> 19.G92200 '00-23
									<b>Valve</b> 28.2200-1 '01-07 1x Exhaust Steel 28.2200-2 '01-07 1x Intake Steel

Footnotes: \* Bearings Only \*\* Rubbers included

<b>DIRT</b> APRILIA BETA BMW GAS GAS HONDA HUSABERG HUSQVARNA KAWASAKI KTM MOTO TM RIEJU SHERCO SUZUKI YAMAHA	<b>Air Filter</b> 52.20087 '87-92 52.20093 '93-01	<b>Basket</b> 17.2193F '94-01	<b>Friction Set</b> 16.S21001 '83-92 16.S21002 '93-94 16.S21003 '95-01	<b>F/W Bearing</b> 23.S110009 '74-92 23.S110025 '93-01	<b>Frontbrake Disc</b> 37.BD12193 '93-01	<b>Front Sprocket</b> 07.FS21093-13 07.FS21093-14 07.FS21093-15 '93-01	<b>Chain</b> 07.RC428130C '78-01 MX	<b>Swingarm</b> 26.210060 '84-92 26.210062 '93-98 26.210061 '99-01	<b>Seal &amp; Wiper</b> 40.S36488P '93-01
	<b>Throttle Cable</b> 53.111095 '83-92 53.111094 '93-01	<b>Spring Kit</b> 17.CS21028 '93-94 17.CS21029 '95-01	<b>R/W Bearing</b> 23.S111085 '84-92 23.S111068 '93-01	<b>Front Pad Set</b> 37.104102 '93-01 37.104102BX '93-01 Box of 10	<b>7075-T6 Alloy Rear Sprocket</b> 07.RA21093-47 07.RA21093-48 07.RA21093-49 07.RA21093-50 07.RA21093-51 07.RA21093-52 '93-01	<b>Upper Chain Roller</b> 33.0002 '81-82 33.0009 '83-01	<b>Linkage</b> 26.110001 '84-92 26.110058 '93-01	<b>Dust Seal Set</b> 40.F3648DP '93-01	
	<b>Water Pump Rebuild Kit</b> 57.2113 '83-92 57.2114 '93-01	<b>Cover Gasket</b> 19.G2193 '93-01	<b>F/W Spacer Kit</b> 26.710061 '93-01	<b>Rear Pad Set</b> 37.200802 '93-01 37.200802BX '93-01 Box of 10	<b>Sprocket Bolt Set</b> 07.SBSM825 '93-01		<b>Lower</b> 26.450013 '93-01	<b>Bushing Set</b> 39.160047 '93-01	
		<b>Clutch Cable</b> 53.120038 '84-92 53.121025 '93-96 53.120037 '97-01	<b>R/W Spacer Kit</b> 26.710076 '93-01	<b>Steering Bearing</b> 24.110008 '74-83 24.110033 '84-92 24.110022 '93-01	<b>Front Caliper Rebuild Kit</b> 37.63014 '86-01 <b>Rear Caliper Rebuild Kit</b> 37.63033 '93-01 <b>Front Master Cylinder Rebuild Kit</b> 37.910017 '86-96 37.910016 '97-01 <b>Rear Master Cylinder Rebuild Kit</b> 37.910007 '93-01			<b>Rear Shock Seal Head Kit</b> 26.810115 '81-92 26.810010 '93-01	
<b>STREET</b> APRILIA CAGIVA HONDA KAWASAKI KTM SUZUKI YAMAHA									
<b>ATV-UTV</b> CAN-AM GAS GAS HONDA KAWASAKI KTM POLARIS SUZUKI YAMAHA	<b>Air Filter</b> 52.20002 '02-23	<b>Basket</b> 17.2196F '03-23	<b>Complete Plate Set</b> 16.CPS21002 '02-23	<b>F/W Bearing</b> 23.S110025 '02-18 23.S117036 '19-23	<b>Frontbrake Disc</b> 37.BD12193 '02-23	<b>Front Sprocket</b> 07.FS21002-13 07.FS21002-14 07.FS21002-15 '02-23	<b>Chain</b> 07.RC428130C '02-23 MX	<b>Swingarm</b> 26.210061 '02-23	<b>Seal &amp; Wiper</b> 40.S36488P '02-23
	<b>Main Jet</b> 45.100-225 '02-23 Keihin	<b>Spring Kit</b> 17.CS21029 '02-23	<b>Friction Set</b> 16.S21003 '02-23	<b>R/W Bearing</b> 23.S111068 '02-23	<b>Rearbrake Disc</b> 37.BD22193 '02-23	<b>Countershaft Seal Kit</b> 26.640024 '02-23	<b>Linkage</b> 26.110058 '02 26.110095 '03-18 26.110193 '19-23	<b>Oil Seal Set</b> 40.F36488P '02-23	
	<b>Pilot Jet</b> 46.040-085 '02-23 Keihin	<b>Cover Gasket</b> 19.G2102 '02-23	<b>Steel Set</b> 16.S21004 '02-23	<b>F/W Spacer Kit</b> 26.710061 '02-18	<b>Front Pad Set</b> 37.104102 '02-23 37.104102BX '02-23 Box of 10	<b>Upper Chain Roller</b> 33.0009 '02-23	<b>Dust Seal Set</b> 40.F3648DP '02-23		
	<b>Carburetor Rebuild Kit</b> 55.10140 '02-18	<b>Clutch Cable</b> 53.120037 '02-18 53.121051 '19-23		<b>R/W Spacer Kit</b> 26.710076 '02-23	<b>Rear Pad Set</b> 37.200802 '02-23 37.200802BX '02-23 Box of 10	<b>Lower</b> 26.450013 '02 26.450015 '03-23	<b>Bushing Set</b> 39.160047 '02-18		
	<b>Throttle Cable</b> 53.110063 '02-18 53.112078 '19-23			<b>Steering Bearing</b> 24.110022 '02-23	<b>Sprocket Bolt Set</b> 07.SBSM825 '02-23		<b>Lower</b> 26.450015 '03-23	<b>Rear Shock Seal Head Kit</b> 26.810010 '02-20	
<b>PWC</b> KAWASAKI POLARIS SEA DOO YAMAHA									
<b>SNOW</b> ARCTIC CAT KAWASAKI LYNX MOTO-SKI POLARIS SKI DOO YAMAHA									
<b>MOPED &amp; SCOOTER</b>	<b>Air Filter</b> 52.22000 '00-23	<b>Clutch Cable</b> 53.121017 '00-23	<b>Friction Set</b> 16.S22055 '00-17	<b>F/W Bearing</b> 23.S112092 '00-09 drum brakes 23.S110041 '00-23 disk brakes	<b>Front Pad Set</b> 37.104102 '00-23 37.104102BX '00-23 Box of 10	<b>Chain</b> 07.RC428130C '00-23 MX	<b>Swingarm</b> 26.210098 '00-23		
	<b>Throttle Cable</b> 53.111095 '00-07			<b>R/W Bearing</b> 23.S112092 '00-23	<b>Front Caliper Rebuild Kit</b> 37.63014 '03-23 <b>Front Master Cylinder Rebuild Kit</b> 37.910001 '00-23	<b>Upper Chain Roller</b> 33.0009 '00-22			

<b>DIRT</b> APRILIA BETA BMW GAS GAS HONDA HUSABERG HUSQVARNA KAWASAKI KTM MOTO TM RIEJU SHERCO SUZUKI YAMAHA	
<b>STREET</b> APRILIA CAGIVA HONDA KAWASAKI KTM SUZUKI YAMAHA	
<b>ATV-UTV</b> CAN-AM GAS GAS HONDA KAWASAKI KTM POLARIS SUZUKI YAMAHA	
<b>PWC</b> KAWASAKI POLARIS SEA DOO YAMAHA	
<b>SNOW</b> ARCTIC CAT KAWASAKI LYNX MOTO-SKI POLARIS SKI DOO YAMAHA	
<b>MOPED &amp; SCOOTER</b>	
<b>MISC. TECH. SPECIAL</b>	





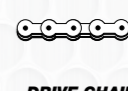

### YAMAHA

**DIRT**  
APRILIA  
BETA  
BMW  
GAS GAS  
HONDA  
HUSABERG  
HUSQVARNA  
KAWASAKI  
KTM  
MOTO TM  
RIEJU  
SHERCO  
SUZUKI  
YAMAHA

YZ 125 X 2-Stroke Please Note: Nikasil Piston Size	<b>Piston Kit</b> 01.2225.A 01.2225.B 01.2225.C 01.2225.D '20-22  01.2232.A 01.2232.B 01.2232.C '23	<b>Size</b> 53.95 53.96 53.97 53.98  53.95 53.96 53.97	<b>Ring Set</b> 02.2222 02.2222 02.2222 02.2222 '20-22  02.2222 02.2222 02.2222 '23	<b>Crank Bearing &amp; Seal Kit</b> 23.CBS22005 '20-23  <b>Bearing</b> 23.6322SH2-9TC4 '20-23 2x  <b>Oilseal Set</b> 42.2225 '20-23	<b>Con. Rod Kit</b> 03.2225 '20-22 03.2232 '23  <b>S/E Bearing</b> 21.2221 '20-23  <b>B/E Bearing</b> 22.222917F '20-23  <b>Crankpin</b> 06.2254.5 '20-23	<b>Complete</b> 34.2225 '20-22  <b>Top-End</b> 35.2225 '20-22 35.2232 '23  <b>Head &amp; Base</b> 36.2205 '20-22 36.2232 '23  <b>Ignition Cover Gasket</b> 19.G92205 '20-23			
---	---	--	---	---	---	---	--	--	--

**STREET**  
APRILIA  
CAGIVA  
HONDA  
KAWASAKI  
KTM  
SUZUKI  
YAMAHA

XT 200 4-Stroke	<b>Piston Kit</b> -	<b>Size</b> 67.00	<b>Ring Set</b> -		<b>Con. Rod Kit</b> 03.2320 '82-83				
--------------------	------------------------	----------------------	----------------------	--	--	--	--	--	--

**ATV-UTV**  
CAN-AM  
GAS GAS  
HONDA  
KAWASAKI  
KTM  
POLARIS  
SUZUKI  
YAMAHA

XT 225 4-Stroke	<b>Piston Kit</b> -	<b>Size</b> 70.00	<b>Ring Set</b> -	<b>Bearing</b> 23.6306C3 Right	<b>Con. Rod Kit</b> 03.2325 '92-07	<b>Complete</b> 34.2292 '92-07  <b>Top-End</b> 35.2399 '93-07  <b>Ignition Cover Gasket</b> 19.G93399 '92-07	<b>Valve</b> 28.2396-1 '92-98 1x Exhaust Steel 28.2396-2 '92-98 1x Intake Steel		
--------------------	------------------------	----------------------	----------------------	--------------------------------------	--	--	---	--	--

**SNOW**  
ARCTIC CAT  
KAWASAKI  
LYNX  
MOTO-SKI  
POLARIS  
SKI DOO  
YAMAHA

**MOPED & SCOOTER**

**MISC. TECH. SPECIAL**

Footnotes: \* Bearings Only \*\* Rubbers included

**DIRT**  
APRILIA  
BETA  
BMW  
GAS GAS  
HONDA  
HUSABERG  
HUSQVARNA  
KAWASAKI  
KTM  
MOTO TM  
RIEJU  
SHERCO  
SUZUKI  
YAMAHA

**STREET**  
APRILIA  
CAGIVA  
HONDA  
KAWASAKI  
KTM  
SUZUKI  
YAMAHA

**ATV-UTV**  
CAN-AM  
GAS GAS  
HONDA  
KAWASAKI  
KTM  
POLARIS  
SUZUKI  
YAMAHA

**PWC**  
KAWASAKI  
POLARIS  
SEA DOO  
YAMAHA

**SNOW**  
ARCTIC CAT  
KAWASAKI  
LYNX  
MOTO-SKI  
POLARIS  
SKI DOO  
YAMAHA

**MOPED & SCOOTER**

**MISC. TECH. SPECIAL**

<b>Air Filter</b> 52.22097 '20-23  <b>Main Jet</b> 47.090-580 '20-22 Mikuni 45.100-225 '23 Keihin  <b>Pilot Jet</b> 49.010-045 '20-22 Mikuni 46.040-085 '23 Keihin  <b>Carburetor Rebuild Kit</b> 55.10145 '20-22  <b>Throttle Cable</b> 53.110069 '20-22 53.112086 '23  <b>Water Pump Rebuild Kit</b> 57.2225 '20-23	<b>Basket</b> 17.2295 '20-23  <b>Spring Kit</b> 17.CS22030 '20-23  <b>Cover Gasket</b> 19.G2205 '20-23  <b>Clutch Cable</b> 53.121015 '20-23	<b>Complete Plate Set</b> 16.CPS22093 '20-23  <b>Friction Set</b> 16.S22006 '20-23  <b>Steel Set</b> 16.S22007 '20-23	<b>F/W Bearing</b> 23.S110092 '20-23  <b>R/W Bearing</b> 23.S112052 '20-23  <b>F/W Spacer Kit</b> 26.710100 '20-23  <b>R/W Spacer Kit</b> 26.710081 '20-23  <b>Steering Bearing</b> 24.110001 '20-23	<b>Frontbrake Disc</b> 37.BD12416 '20-23  <b>Rearbrake Disc</b> 37.BD22418 '20-22 37.BD22420 '23  <b>Front Pad Set</b> 37.105802 '20-22 37.105802BX '20-22 Box of 10 37.180302 '23 37.180302BX '23 Box of 10  <b>Rear Pad Set</b> 37.201302 '20-23 37.201302BX '20-23 Box of 10  <b>Front Caliper Rebuild Kit</b> 37.63011 '20-23  <b>Rear Caliper Rebuild Kit</b> 37.63032 '20-22  <b>Front Master Cylinder Rebuild Kit</b> 37.910010 '20-23  <b>Rear Master Cylinder Rebuild Kit</b> 37.910019 '20-23	<b>Front Sprocket</b> 07.FS22005-12 07.FS22005-13 07.FS22005-14 07.FS22005-15 '20-23  <b>7075-T6 Alloy Rear Sprocket</b> 07.RA22099-47 07.RA22099-48 07.RA22099-49 07.RA22099-50 07.RA22099-51 07.RA22099-52 '20-23  <b>UltraLight Steel Rear Sprocket</b> 07.RS22099R-47 07.RS22099R-48 07.RS22099R-49 07.RS22099R-50 07.RS22099R-51 07.RS22099R-52 '20-23  <b>Sprocket Bolt Set</b> 07.SBSM825 '20-23	<b>Chain</b> 07.RC520120C '20-23 MX 07.RC520120CG '20-23 MX Gold 07.RC520120XC '20-23 X-Ring 07.RC520120XCG '20-23 X-Ring Gold  <b>Countershaft Seal Kit</b> 26.640023 '20-23  <b>Lower Chain Roller</b> 33.0007 '20-23  <b>Upper Chain Roller</b> 33.0008 '20-23	<b>Swingarm</b> 26.210160 '20-23  <b>Linkage</b> 26.110170 '20-23  <b>Upper</b> 26.310016 '20-23  <b>Lower</b> 26.450015 '20-23	<b>Seal &amp; Wiper</b> 40.S485810 '20-23  <b>Oil Seal Set</b> 40.F485810 '20-23  <b>Dust Seal Set</b> 40.F4858D '20-23  <b>Rear Shock Seal Head Kit</b> 26.810117 '20
---	--	---	--	---	--	---	---	--

			<b>Steering Bearing</b> 24.110008 '82-83		<b>Chain</b> 07.RC428130C '82-83 MX				
--	--	--	--	--	---	--	--	--	--

<b>Throttle Cable</b> 53.111075 '01-07	<b>Clutch Cable</b> 53.121029 '01-07		<b>F/W Bearing</b> 23.S114044 '92-07  <b>Steering Bearing</b> 24.110025 '92-07	<b>Front Master Cylinder Rebuild Kit</b> 37.910018 '01-07		<b>Chain</b> 07.RC428130C '92-07 MX	<b>Swingarm</b> 26.210122 '92-07		
--	--	--	--	---	--	---	--	--	--

**SNOW**  
ARCTIC CAT  
KAWASAKI  
LYNX  
MOTO-SKI  
POLARIS  
SKI DOO  
YAMAHA

**MOPED & SCOOTER**

**MISC. TECH. SPECIAL**

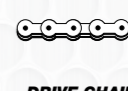

YAMAHA

DIRT	XT 250 4-Stroke	Piston Kit -	Size 74.00	Ring Set -			Top-End 35.2358 '08-23	Cam Chain 31.1323 '08-23
APRILIA BETA BMW GAS GAS HONDA HUSABERG HUSQVARNA KAWASAKI KTM MOTO TM RIEJU SHERCO SUZUKI YAMAHA								
STREET	WR 250 2-Stroke Please Note: Nikasil Piston Size -Molycoated Skirt	Piston Kit 01.2314.B 01.2314.C 01.2314.D & 01.2314.050 01.2314.100 '88-97	Size 67.95 67.96 67.97 68.50 69.00	Ring Set 02.2314 02.2314 02.2314 02.2314.050 02.2314.100 '88-97	Bearing 23.6328C3 '88-97 2x	S/E Bearing 21.3303 '88-97		
APRILIA CAGIVA HONDA KAWASAKI KTM SUZUKI YAMAHA				Pin 04.1859 '88-97  Clips 05.1812 '88-97				
ATV-UTV								
CAN-AM GAS GAS HONDA KAWASAKI KTM POLARIS SUZUKI YAMAHA								
PWC								
KAWASAKI POLARIS SEA DOO YAMAHA								
SNOW								
ARCTIC CAT KAWASAKI LYNX MOTO-SKI POLARIS SKI DOO YAMAHA								
MOPED & SCOOTER								
MISC. TECH. SPECIAL								

Footnotes: \* Bearings Only \*\* Rubbers included

AIR & FUEL PARTS	CLUTCH PARTS	CLUTCH PLATE SETS	WHEEL & STEERING PARTS	BRAKE PARTS	DRIVE CHAIN PARTS I	DRIVE CHAIN PARTS II	SUSPENSION BEARING KITS	SUSPENSION PARTS
Oil Filter 54.23140 '08-23 1-Pce. 54.23140-50 '08-23 50-Pcs.			F/W Bearing 23.S114044 '08-23  Steering Bearing 24.110022 '08-23	Rear Caliper Rebuild Kit 37.63031 '08-23  Front Master Cylinder Rebuild Kit 37.910001 '08-23  Rear Master Cylinder Rebuild Kit 37.910007 '08-23		Chain 07.RC428130C '08-23 MX		
Air Filter 52.22089 '89-97  Main Jet 45.100-225 '88-97 Keihin  Pilot Jet 46.040-085 '88-97 Keihin  Carburetor Rebuild Kit 55.10579 '91	Spring Kit 17.CS23032 '93-98  Clutch Cable 53.121010 '91-97	Friction Set 16.S23014 '91-93 16.S23015 '94-97	F/W Bearing 23.S114044 '91 23.S110054 '92-97  R/W Bearing 23.S112071 '91-97  R/W Spacer Kit 26.710079 '92-97  Steering Bearing 24.110001 '91-97	Front Pad Set 37.100202 '91-97 37.100202BX '91-97 Box of 10  Rear Pad Set 37.201202 '91-97 37.201202BX '91-97 Box of 10  Front Caliper Rebuild Kit 37.63010 '89-97  Rear Caliper Rebuild Kit 37.63035 '91-97  Front Master Cylinder Rebuild Kit 37.910001 '91-96 37.910016 '97  Rear Master Cylinder Rebuild Kit 37.910007 '91-97	Front Sprocket 07.FS23080-13 07.FS23080-14 07.FS23080-15 '88-97  7075-T6 Alloy Rear Sprocket 07.RA22080-48 07.RA22080-49 07.RA22080-50 07.RA22080-51 07.RA22080-52 '90-97  UltraLight Steel Rear Sprocket 07.RS22080R-48 07.RS22080R-49 07.RS22080R-50 07.RS22080R-51 07.RS22080R-52 '88-97  Sprocket Bolt Set 07.SBSM825 '88-97	Chain 07.RC520120C '88-97 MX 07.RC520120CG '88-97 MX Gold 07.RC520120XC '88-97 X-Ring 07.RC520120XCG '88-97 X-Ring Gold  Countershaft Seal Kit 26.640022 '91-97  Lower Chain Roller 33.0007 '91-97  Upper Chain Roller 33.0007 '91-93 33.0008 '94-97	Swingarm 26.210075 '91-93 26.210078 '94-97  Linkage 26.110084 '91-93 26.110088 '94-97  Upper 26.310010 '91-97  Lower 26.450013 '91-93 26.450016 '94-97	Bushing Set 39.160048 '92-93 39.160014 '94-97  Rear Shock Seal Head Kit 26.810002 '94-97

DIRT
APRILIA BETA BMW GAS GAS HONDA HUSABERG HUSQVARNA KAWASAKI KTM MOTO TM RIEJU SHERCO SUZUKI YAMAHA
STREET
APRILIA CAGIVA HONDA KAWASAKI KTM SUZUKI YAMAHA
ATV-UTV
CAN-AM GAS GAS HONDA KAWASAKI KTM POLARIS SUZUKI YAMAHA
PWC
KAWASAKI POLARIS SEA DOO YAMAHA
SNOW
ARCTIC CAT KAWASAKI LYNX MOTO-SKI POLARIS SKI DOO YAMAHA
MOPED & SCOOTER
MISC. TECH. SPECIAL



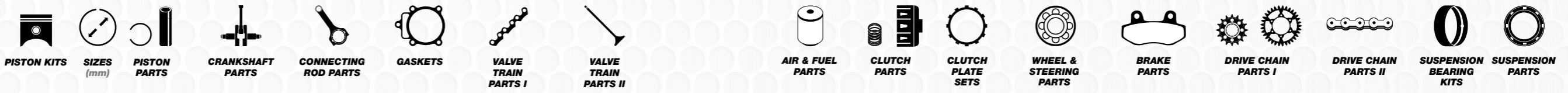

**YAMAHA**

DIRT	YZ 250	Piston Kit	Size	Ring Set	Crank Bearing & Seal Kit	Con. Rod Kit	Complete	
APRILIA BETA BMW GAS GAS HONDA HUSABERG HUSQVARNA KAWASAKI KTM MOTO TM RIEJU SHERCO SUZUKI YAMAHA	2-Stroke	01.2314.B 01.2314.C 01.2314.D	67.95 67.96 67.97	02.2314 02.2314 02.2314	23.CBS23083 '83-87 23.CBS23088 '88-97 23.CBS23098 '98 23.CBS23099 '99-00 23.CBS23001 '01-23	03.2304 '83-89 03.2306 '90-91 03.2309 '99-23	34.2308 '88-89 34.2310 '90-91 34.2312 '92-94 34.2315 '95-96 34.2317 '97-98 34.2319 '99-00 34.2322 '02-22	
	Please Note: Nikasil Piston Size							
	Replating or Cylinder Sleaving Required for Oversizes -Molycoated Skirt	01.2314.050 01.2314.100	68.50 69.00	02.2314.050 02.2314.100				
	Please Note: Nikasil Piston Size -Molycoated Skirt	01.2321.A 01.2321.B 01.2321.C 01.2321.D	66.35 66.36 66.37 66.38	02.2319 02.2319 02.2319 02.2319				
					<b>Bearing</b> 23.6206C3 '77-87 2x 23.6328C3 '88-23 2x	<b>S/E Bearing</b> 21.3303 '83-98 21.2309 '99-23	<b>Top-End</b> 35.2308 '88-89 35.2310 '90-91 35.2312 '92-94 35.2315 '95-96 35.2317 '97-98 35.2319 '99-01 35.2320 '02-23	
				<b>Pin</b> 04.1859 '83-98 04.1853.3 '99-23	<b>Oilseal Set</b> 42.2300 '76-87 42.2308 '88-97 42.2318 '98 42.2319 '99-00 42.2321 '01-23	<b>Crankpin</b> 06.2459 '83-87 '99-23		
				<b>Clips</b> 05.1812 '83-23		<b>Washers</b> 03W.24411.0 '99-23		
							<b>Head &amp; Base</b> 36.2397 '97-98 36.2399 '99-23	
							<b>Ignition Cover Gasket</b> 19.G92388 '88-98 19.G92399 '99-23	

Footnotes: \* Bearings Only \*\* Rubbers included

Air Filter	Basket	Complete Plate Set	F/W Bearing	Frontbrake Disc	Front Sprocket	Chain	Swingarm	Seal & Wiper	
52.22089 '89-92 52.22093 '93-94 52.22095 '95-96 52.22097 '97-23	17.2393 * '93-23 <b>Clutch Rubber Set</b> 17.CRS2288-8 '93-23 <b>Spring Kit</b> 17.CS23032 '93-01 17.CS23033 '02-23	16.CPS23094 '94-01 16.CPS23002 '02-23 <b>Friction Set</b> 16.S23011 '83-87 16.S23012 '88-90 16.S23014 '91-92 16.S23015 '93-23	23.S114044 '83-91 23.S110054 '92-95 23.S110090 '96-97 23.S110092 '98-23	37.BD13288 '01-16 37.BD12416 '17-23 <b>Rearbrake Disc</b> 37.BD22202 '02-18 37.BD22418 '19-21 37.BD22420 '22-23	07.FS23080-13 07.FS23080-14 07.FS23080-15 '80-98 07.FS23099-13 07.FS23099-14 07.FS23099-15 '99-23	'76-23 MX 07.RC520120CG '76-23 MX Gold 07.RC520120XC '76-23 X-Ring 07.RC520120XCG '76-23 X-Ring Gold	26.210026 '83-85 26.210075 '88-92 26.210078 '93-97 26.210076 '98 26.210073 '99-01 26.210072 '02-05	40.S435511 '81-86 40.S43559 '87-88 40.S43559 '91-95 40.S46589 '96-03 40.S485810 '04-23 <b>Oil Seal Set</b> 40.F435511 '81-86 40.F43559 '87-88	
<b>Main Jet</b> 45.100-225 '96-23 Keihin			<b>R/W Bearing</b> 23.S112067 '83-87 23.S112071 '88-98 23.S112052 '99-23		<b>7075-T6 Alloy Rear Sprocket</b> 07.RA22080-48 07.RA22080-49 07.RA22080-50 07.RA22080-51 07.RA22080-52 '80-98	<b>Countershaft Seal Kit</b> 26.640022 '78-98 26.640021 '99-23	<b>Linkage</b> 26.110109 '83-85 26.110081 '86-87 26.110080 '88-89 26.110084 '90-92	<b>Dust Seal Set</b> 40.F4355DP '81-86 40.F4355DP '87-88 40.F4355DP '91-95 40.F4658D '96-03 40.F4858D '04-23	
<b>Pilot Jet</b> 46.040-085 '96-23 Keihin	<b>Cover Gasket</b> 19.G2390 '90-98 19.G2399 '99-20	<b>Steel Set</b> 16.S23013 '88-90 16.S23016 '94-23	<b>F/W Spacer Kit</b> 26.710069 '99-01 26.710070 '02-07 26.710100 '08-23	<b>Front Pad Set</b> 37.100202 '89-97 37.100202BX '89-97 Box of 10 37.103202 '98-07 37.103202BX '98-07 Box of 10 37.105802 '08-21 37.105802BX '08-21 Box of 10 37.180302 '22-23 37.180302BX '22-23 Box of 10		<b>Lower Chain Roller</b> 33.0009 '83-86 33.0007 '87-23	<b>Upper Chain Roller</b> 33.0009 '83-86 33.0007 '87-92 33.0008 '93-23	<b>Upper</b> 26.310020 '83-88 26.310010 '89-97 26.310016 '98-23	<b>Bushing Set</b> 39.160048 '82-88 39.160048 '91-92 39.160014 '93-95 39.160010 '96-03 39.160050 '04 39.160068 '05-16 39.160126 '17-18
<b>Carburetor Rebuild Kit</b> 55.10578 '90 55.10531 '91 55.10530 '92-94 55.10528 '96 55.10291 '97 55.10280 '00 55.10205 '01-21	<b>Clutch Cable</b> 53.121011 '83-87 53.121010 '88-98 53.120029 '99-03 53.120028 '04 53.120027 '05-23		<b>R/W Spacer Kit</b> 26.710079 '88-98 26.710080 '99-01 26.710081 '02-23	<b>Rear Pad Set</b> 37.200802 '85-89 37.200802BX '85-89 Box of 10 37.201202 '90-97 37.201202BX '90-97 Box of 10 37.207102 '98-02 37.207102BX '98-02 Box of 10 37.201302 '03-23 37.201302BX '03-23 Box of 10	<b>Ultraight Steel Rear Sprocket</b> 07.RS22080R-48 07.RS22080R-49 07.RS22080R-50 07.RS22080R-51 07.RS22080R-52 '80-98		<b>Sprocket Bolt Set</b> 07.SBSM825 '80-23	<b>Lower</b> 26.450027 '83-89 26.450013 '90-92 26.450016 '93-00 26.450015 '01-23	<b>Rear Shock Seal Head Kit</b> 26.810116 '83-88 26.810002 '93-05 26.810117 '06-20
<b>Throttle Cable</b> 53.110065 '89-94 53.110067 '96-98 53.110068 '99 53.110074 '00-05 53.110069 '06-23				<b>Steering Bearing</b> 24.110024 '88-95 24.110001 '96-23					
<b>Water Pump Rebuild Kit</b> 57.2313 '83-87 57.2328 '88-97 57.2318 '98 57.2319 '99-23					<b>Front Caliper Rebuild Kit</b> 37.63015 '85-88 37.63010 '89-97 37.63005 '98-07 37.63011 '08-23				
					<b>Rear Caliper Rebuild Kit</b> 37.63034 '90-97 37.63028 '98-02 37.63032 '03-21				
					<b>Front Master Cylinder Rebuild Kit</b> 37.910017 '85-89 37.910001 '90-95 37.910016 '96-00 37.910002 '01-07 37.910010 '08-23				
					<b>Rear Master Cylinder Rebuild Kit</b> 37.910007 '88-02 37.910019 '03-23				

**STREET****ATV-UTV****PWC****SNOW****MOPED & SCOOTER****MISC. TECH. SPECIAL****DIRT****STREET****ATV-UTV****PWC****SNOW****MOPED & SCOOTER****MISC. TECH. SPECIAL**

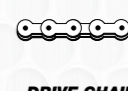

### YAMAHA

**DIRT**  
APRILIA  
BETA  
BMW  
GAS GAS  
HONDA  
HUSABERG  
HUSQVARNA  
KAWASAKI  
KTM  
MOTO TM  
RIEJU  
SHERCO  
SUZUKI  
YAMAHA

YZ 250 X  
2-Stroke  
Please Note:  
Nikasil Piston Size  
-Molycoated Skirt

**Piston Kit**  
01.2321.A  
01.2321.B  
01.2321.C  
01.2321.D  
'16-23

**Size (mm)**  
66.35  
66.36  
66.37  
66.38

**Ring Set**  
02.2319  
02.2319  
02.2319  
02.2319  
'16-23

**Crank Bearing & Seal Kit**  
23.CBS23001  
'16-23  
**Bearing**  
23.6328C3  
'16-23 2x  
**Pin**  
04.1853.3  
'16-23  
**Oilseal Set**  
42.2321  
'16-23  
**Clips**  
05.1812  
'16-23

**Con. Rod Kit**  
03.2309  
'16-23  
**S/E Bearing**  
21.2309  
'16-23  
**B/E Bearing**  
22.243117F  
'16-23  
**Crankpin**  
06.2459  
'16-23

**Complete**  
34.2322  
'16-22  
**Top-End**  
35.2320  
'16-23  
**Head & Base**  
36.2399  
'16-23  
**Ignition Cover Gasket**  
19.G92399  
'16-23

**STREET**  
APRILIA  
CAGIVA  
HONDA  
KAWASAKI  
KTM  
SUZUKI  
YAMAHA

**ATV-UTV**  
CAN-AM  
GAS GAS  
HONDA  
KAWASAKI  
KTM  
POLARIS  
SUZUKI  
YAMAHA

**PWC**  
KAWASAKI  
POLARIS  
SEA DOO  
YAMAHA

**SNOW**  
ARCTIC CAT  
KAWASAKI  
LYNX  
MOTO-SKI  
POLARIS  
SKI DOO  
YAMAHA

**MOPED & SCOOTER**

**MISC. TECH. SPECIAL**

Footnotes: \* Bearings Only \*\* Rubbers included

**DIRT**  
APRILIA  
BETA  
BMW  
GAS GAS  
HONDA  
HUSABERG  
HUSQVARNA  
KAWASAKI  
KTM  
MOTO TM  
RIEJU  
SHERCO  
SUZUKI  
YAMAHA

**STREET**  
APRILIA  
CAGIVA  
HONDA  
KAWASAKI  
KTM  
SUZUKI  
YAMAHA

**ATV-UTV**  
CAN-AM  
GAS GAS  
HONDA  
KAWASAKI  
KTM  
POLARIS  
SUZUKI  
YAMAHA

**PWC**  
KAWASAKI  
POLARIS  
SEA DOO  
YAMAHA

**SNOW**  
ARCTIC CAT  
KAWASAKI  
LYNX  
MOTO-SKI  
POLARIS  
SKI DOO  
YAMAHA

**MOPED & SCOOTER**

**MISC. TECH. SPECIAL**

**Air Filter**  
52.22097  
'16-23  
**Main Jet**  
45.100-225  
'16-23 Keihin  
**Pilot Jet**  
46.040-085  
'16-23 Keihin  
**Carburetor Rebuild Kit**  
55.10205  
'16-21  
**Throttle Cable**  
53.110069  
'16-23  
**Water Pump Rebuild Kit**  
57.2319  
'16-23

**Basket**  
17.2393 \*  
'16-23  
**Clutch Rubber Set**  
17.CRS2288-8  
'16-23  
**Spring Kit**  
17.CS23033  
'16-23  
**Cover Gasket**  
19.G2399  
'16-23  
**Clutch Cable**  
53.120027  
'16-23

**Complete Plate Set**  
16.CPS23002  
'16-22  
**Friction Set**  
16.S23015  
'16-22  
**Steel Set**  
16.S23016  
'16-23

**F/W Bearing**  
23.S110092  
'16-23  
**R/W Bearing**  
23.S112052  
'16-23  
**F/W Spacer Kit**  
26.710100  
'16-23  
**R/W Spacer Kit**  
26.710081  
'16-23  
**Steering Bearing**  
24.110001  
'16-23

**Frontbrake Disc**  
37.BD13288  
'16  
37.BD12416  
'17-23  
**Rearbrake Disc**  
37.BD22202  
'16-18  
37.BD22418  
'19-22  
37.BD22420  
'23  
**Front Pad Set**  
37.105802  
'16-22  
37.105802BX  
'16-22 Box of 10  
37.180302  
'23  
37.180302BX  
'23 Box of 10  
**Rear Pad Set**  
37.201302  
'16-23  
37.201302BX  
'16-23 Box of 10  
**Front Caliper Rebuild Kit**  
37.63011  
'16-23  
**Rear Caliper Rebuild Kit**  
37.63032  
'16-22  
**Front Master Cylinder Rebuild Kit**  
37.910010  
'16-23  
**Rear Master Cylinder Rebuild Kit**  
37.910019  
'16-23

**Front Sprocket**  
07.FS23099-13  
07.FS23099-14  
07.FS23099-15  
'16-23  
**7075-T6 Alloy Rear Sprocket**  
07.RA22099-47  
07.RA22099-48  
07.RA22099-49  
07.RA22099-50  
07.RA22099-51  
07.RA22099-52  
'16-23  
**Ultralight Steel Rear Sprocket**  
07.RS22099R-47  
07.RS22099R-48  
07.RS22099R-49  
07.RS22099R-50  
07.RS22099R-51  
07.RS22099R-52  
'16-23  
**Sprocket Bolt Set**  
07.SBSM825  
'16-23

**Chain**  
07.RC520120C  
'16-23 MX  
07.RC520120CG  
'16-23 MX Gold  
07.RC520120XC  
'16-23 X-Ring  
07.RC520120XCG  
'16-23 X-Ring Gold  
**Countershaft Seal Kit**  
26.640021  
'16-23  
**Lower Chain Roller**  
33.0007  
'16-23  
**Upper Chain Roller**  
33.0008  
'16-23

**Swingarm**  
26.210158  
'16-23  
**Linkage**  
26.110170  
'16-23  
**Upper**  
26.310016  
'16-23  
**Lower**  
26.450015  
'16-23

**Seal & Wiper**  
40.S485810  
'16-23  
**Oil Seal Set**  
40.F485810  
'16-23  
**Dust Seal Set**  
40.F4858D  
'16-23  
**Bushing Set**  
39.160068  
'16  
39.160126  
'17-18  
**Rear Shock Seal Head Kit**  
26.810117  
'16-20



YAMAHA

DIRT  
APRILIA  
BETA  
BMW  
GAS GAS  
HONDA  
HUSABERG  
HUSQVARNA  
KAWASAKI  
KTM  
MOTO TM  
RIEJU  
SHERCO  
SUZUKI  
YAMAHA

STREET  
APRILIA  
CAGIVA  
HONDA  
KAWASAKI  
KTM  
SUZUKI  
YAMAHA

ATV-UTV  
CAN-AM  
GAS GAS  
HONDA  
KAWASAKI  
KTM  
POLARIS  
SUZUKI  
YAMAHA

PWC  
KAWASAKI  
POLARIS  
SEA DOO  
YAMAHA

SNOW  
ARCTIC CAT  
KAWASAKI  
LYNX  
MOTO-SKI  
POLARIS  
SKI DOO  
YAMAHA

MOPED & SCOOTER

MISC. TECH. SPECIAL

YZ 250 F 4-Stroke	Piston Kit 01.2406.A 01.2406.B 01.2406.C & 01.2401.200 '01-07	Size 76.95 76.96 76.97	Ring Set 02.2402 02.2402 02.2402	Crankshaft 10.2403 '03-13 10.2416 '14-18	Con. Rod Kit 03.2401 '01-02 03.2403 '03-13 03.2414 '14-23	Complete 34.2401 '01-13 34.2414 '14-18	Cam Chain 31.2402 '01-13 31.2414 '14-23	Valve 28.2401-1 '01-13 2x Exhaust Titanium 28.2401-2 '01-13 1x Intake I Titanium 28.2401-3 '01-13 2x Intake II Titanium 28.2414-1 '14-23 2x Exhaust Titanium 28.2414-2 '14-18 2x Intake Titanium 28.2419-2 '19-23 2x Intake Titanium
Please Note: Nikasil Piston Size -Std. Compression 12.5:1 -Forged Piston	01.2409.A 01.2409.B 01.2409.C '08-11	76.95 76.96 76.97	02.2402 02.2402 02.2402	<b>Crankbearing &amp; Seal Kit</b> 23.CBS24001* '01-23	<b>B/E Bearing</b> 22.303818F '01-02 22.324018F '03-13 22.303818F-1 '14-23	<b>Top-End</b> 35.2401 '01-13 35.2414 '14-18 35.2419 '19-23	<b>Valve Shim Assortment</b> 29.VSA748 '01-13 29.VSA748-2 '01-13 29.VSA948 '14-23 29.VSA948-2 '14-23	<b>Head &amp; Base</b> 36.2301 '01-13 36.2314 '14-18 36.2319 '19-23  <b>Ignition Cover Gasket</b> 19.G92401 '01-13 19.G92314 '14-18
Please Note: Nikasil Piston Size -Std. Compression 13.5:1 -Forged Piston	01.2412.A 01.2412.B 01.2412.C '12-13	76.95 76.96 76.97	02.6307 02.6307 02.6307	<b>Bearing</b> 23.830046-1 '01-23 2x	<b>Washers</b> 03W.30501.0 '16-23 2x	<b>TI-Steel Conversion Kit</b> 28.SES2402-1 '01-13 Exhaust 28.SIS2402-2 '01-13 Intake 28.SES2414-1 '14-18 Exhaust 28.SIS2414-2 '14-18 Intake	<b>Valve Seal</b> 35.VS011 '01-13 3x Intake 35.VS012 '01-13 2x Exhaust 35.VS013 '14-23 2x Intake 35.VS027 '14-23 2x Exhaust	
Please Note: Nikasil Piston Size -Std. Compression 13.5:1 -Forged Piston	01.2414.A 01.2414.B 01.2414.C '14-15	76.95 76.96 76.97	02.3340 02.3340 02.3340					
Please Note: Nikasil Piston Size -Std. Compression 13.5:1 -Forged Piston	01.2417.A 01.2417.B 01.2417.C '16-18	76.95 76.96 76.97	02.3340 02.3340 02.3340					
Please Note: Nikasil Piston Size -Std. Compression 13.8:1 -Forged Piston -Fuel Injection	01.2439.A 01.2439.B 01.2439.C '19-23	76.95 76.96 76.97	02.3340 02.3340 02.3340					
Replating or Cylinder Sleeving Required for Oversizes								
			<b>Pin</b> 04.1644.4 '01-11					
			<b>Clips</b> 05.1612C '01-23					

Footnotes: \* Bearings Only \*\* Rubbers included

Air Filter 52.22097 '01-13 52.24014 '14-18 52.24018 '19-23	Basket 17.2401F * '01-08	Complete Plate Set 16.CPS23001 '01-07 16.CPS23008 '08-13 16.CPS23114 '14-18 16.CPS23115 '19-23 17.CS23033 '19-23	F/W Bearing 23.S110092 '01-13 23.S114082 '14-23	Frontbrake Disc 37.BD13288 '01-15 37.BD12416 '16-23	Front Sprocket 07.FS22005-12 07.FS22005-13 07.FS22005-14 07.FS22005-15 '01-23	Chain 07.RC520120C '01-23 MX 07.RC520120CG '01-23 MX Gold 07.RC520120XC '01-23 X-Ring 07.RC520120XCG '01-23 X-Ring Gold	Swingarm 26.210073 '01 26.210072 '02-05 26.210158 '06-13 26.210202 '14-23	Seal & Wiper 40.S46589 '01-03 40.S485810 '04-23
<b>Main Jet</b> 45.100-225 '01-13 Keihin	<b>Spring Kit</b> 17.CS23034 '01-07 17.CS22030 '08-13 17.CS23059 '14-18 17.CS23033 '19-23	<b>Friction Set</b> 16.S23017 '01-07 16.S23049 '08-18 16.S23065 '19-23	<b>R/W Bearing</b> 23.S112052 '01-08 23.S114006 '09-23	<b>Rearbrake Disc</b> 37.BD22202 '02-18 37.BD22418 '19-20 37.BD22420 '21-23	<b>7075-T6 Alloy Rear Sprocket</b> 07.RA22099-47 07.RA22099-48 07.RA22099-50 07.RA22099-51 07.RA22099-52 '01-23	<b>Countershaft Seal Kit</b> 26.640020 '01-13 26.640044 '14-23	<b>Linkage</b> 26.110067 '01 26.110065 '02-04 26.110128 '05	<b>Dust Seal Set</b> 40.F4658D '01-03 40.F4858D '04-23
<b>Pilot Jet</b> 46.040-085 '01-13 Keihin	<b>Cover Gasket</b> 19.G2301 '01-13 19.G2314 '14-18	<b>Steel Set</b> 16.S23018 '01-18 16.S43025 '19-23	<b>F/W Spacer Kit</b> 26.710069 '01 26.710070 '02-06 26.710100 '07-13 26.710104 '14-18 26.710107 '19-23	<b>Front Pad Set</b> 37.103202 '01-06 37.103202BX '01-06 Box of 10 37.105802 '07-20 37.105802BX '07-20 Box of 10 37.180302 '21-23 37.180302BX '21-23 Box of 10	<b>UltraLight Steel Rear Sprocket</b> 07.RS22099R-47 07.RS22099R-48 07.RS22099R-49 07.RS22099R-50 07.RS22099R-51 07.RS22099R-52 '01-23	<b>Lower Chain Roller</b> 33.0007 '01-18	<b>Bushing Set</b> 39.160010 '01-03 39.160050 '04 39.160068 '05-17 39.160126 '18	
<b>Carburetor Rebuild Kit</b> 55.10287 '01-02 55.10285 '03 55.10282 '04 55.10278 '05-07 55.10275 '08-09 55.10274 '10-11 55.10273 '12-13	<b>Clutch Cable</b> 53.120024 '01-02 53.121008 '03-05 53.121009 '06-08 53.120026 '09-13 53.120132 '14-18 53.120144 '19-20 53.121053 '21-23	<b>Steering Bearing</b> 24.110001 '01-23	<b>R/W Spacer Kit</b> 26.710081 '01 26.710099 '09-23	<b>Rear Pad Set</b> 37.207102 '01-02 37.207102BX '01-02 Box of 10 37.201302 '03-23 37.201302BX '03-23 Box of 10	<b>Sprocket Bolt Set</b> 07.SBSM825 '01-23	<b>Upper Chain Roller</b> 33.0008 '01-23	<b>Rear Shock Seal Head Kit</b> 26.810002 '01-05 26.810117 '06-11 26.810004 '12-13 26.810001 '14-20	
<b>Throttle Cable</b> 53.111078 '01-02 53.111076 '03-06 53.111072 '07-13 53.110251 '14-18 53.112079 '19-23	<b>Oil Filter</b> 54.23142 '01-02 1-Pce. 54.23142-50 '01-02 50-Pcs. 54.23140 '03-23 1-Pce. 54.23140-50 '03-23 50-Pcs.	<b>Water Pump Rebuild Kit</b> 57.2321 '01-13 57.2324 '14-18		<b>Front Caliper Rebuild Kit</b> 37.63005 '01-06 37.63011 '07-23		<b>Front Master Cylinder Rebuild Kit</b> 37.910002 '01-07 37.910010 '08-23		
				<b>Rear Caliper Rebuild Kit</b> 37.63028 '01-03 37.63032 '04-23		<b>Rear Master Cylinder Rebuild Kit</b> 37.910007 '01-02 37.910019 '03-23		

DIRT  
APRILIA  
BETA  
BMW  
GAS GAS  
HONDA  
HUSABERG  
HUSQVARNA  
KAWASAKI  
KTM  
MOTO TM  
RIEJU  
SHERCO  
SUZUKI  
YAMAHA

STREET  
APRILIA  
CAGIVA  
HONDA  
KAWASAKI  
KTM  
SUZUKI  
YAMAHA

ATV-UTV  
CAN-AM  
GAS GAS  
HONDA  
KAWASAKI  
KTM  
POLARIS  
SUZUKI  
YAMAHA

PWC  
KAWASAKI  
POLARIS  
SEA DOO  
YAMAHA

SNOW  
ARCTIC CAT  
KAWASAKI  
LYNX  
MOTO-SKI  
POLARIS  
SKI DOO  
YAMAHA

MOPED & SCOOTER

MISC. TECH. SPECIAL



YAMAHA

DIRT  
APRILIA  
BETA  
BMW  
GAS GAS  
HONDA  
HUSABERG  
HUSQVARNA  
KAWASAKI  
KTM  
MOTO TM  
RIEJU  
SHERCO  
SUZUKI  
YAMAHA

YZ 250 FX 4-Stroke Please Note: Nikasil Piston Size -Std. Compression 13.5:1 -Forged Piston -Fuel Injection	<b>Piston Kit</b> 01.2414.A 01.2414.B 01.2414.C '15-16	<b>Size (mm)</b> 76.95 76.96 76.97	<b>Ring Set</b> 02.3340 02.3340 02.3340 '15-23	<b>Crank Bearing &amp; Seal Kit</b> 23.CBS24001* '15-23  <b>Bearing</b> 23.830046-1 '15-23 2x	<b>Con. Rod Kit</b> 03.2414 '15-23  <b>B/E Bearing</b> 22.303818F-1 '15-23  <b>Crankpin</b> 06.3054.8-1 '15-23  <b>Washers</b> 03W.30501.0 '16-23 2x	<b>Complete</b> 34.2414 '15-19  <b>Top-End</b> 35.2414 '15-19 35.2419 '20-23  <b>Head &amp; Base</b> 36.2314 '15-19 36.2319 '20-23  <b>Ignition Cover Gasket</b> 19.G92314 '15-19	<b>Cam Chain</b> 31.2414 '15-23  <b>Valve Shim Assortment</b> 29.VSA948 '15-23 29.VSA948-2 '15-23	<b>Valve</b> 28.2414-1 '15-23 2x Exhaust Titanium 28.2414-2 '15-19 2x Intake Titanium 28.2419-2 '20-23 2x Intake Titanium  <b>TI-Steel Conversion Kit</b> 28.SES2414-1 '15-18 Exhaust 28.SIS2414-2 '15-19 Intake  <b>Valve Seal</b> 35.VS013 '15-23 2x Intake 35.VS027 '15-23 2x Exhaust
	<b>01.2417.A</b> 01.2417.B 01.2417.C '17-19	76.95 76.96 76.97	02.3340 02.3340 02.3340 '15-23					
	<b>01.2439.A</b> 01.2439.B 01.2439.C '20-23	76.95 76.96 76.97	02.3340 02.3340 02.3340 '15-23					
			<b>Clips</b> 05.1612C '15-23					

STREET  
APRILIA  
CAGIVA  
HONDA  
KAWASAKI  
KTM  
SUZUKI  
YAMAHA

ATV-UTV  
CAN-AM  
GAS GAS  
HONDA  
KAWASAKI  
KTM  
POLARIS  
SUZUKI  
YAMAHA

PWC  
KAWASAKI  
POLARIS  
SEA DOO  
YAMAHA

SNOW  
ARCTIC CAT  
KAWASAKI  
LYNX  
MOTO-SKI  
POLARIS  
SKI DOO  
YAMAHA

MOPED & SCOOTER

MISC. TECH. SPECIAL

Footnotes: \* Bearings Only \*\* Rubbers included

<b>Air Filter</b> 52.24014 '15-19 52.24018 '20-23  <b>Throttle Cable</b> 53.110251 '15-19 53.112079 '20-23  <b>Oil Filter</b> 54.23140 '15-23 1-Pce. 54.23140-50 '15-23 50-Pcs.  <b>Water Pump Rebuild Kit</b> 57.2324 '15-19	<b>Cover Gasket</b> 19.G2314 '15-19  <b>Clutch Cable</b> 53.121038 '15-19 53.120144 '20 53.121053 '21-23	<b>Friction Set</b> 16.S23049 '15-19 16.S23065 '20-23  <b>Steel Set</b> 16.S23018 '15-19 16.S43025 '20-23	<b>F/W Bearing</b> 23.S114082 '15-23  <b>R/W Bearing</b> 23.S112052 '15-23  <b>F/W Spacer Kit</b> 26.710104 '15-23  <b>R/W Spacer Kit</b> 26.710081 '15-23  <b>Steering Bearing</b> 24.110001 '15-23	<b>Frontbrake Disc</b> 37.BD13288 '15-16 37.BD12416 '17-23  <b>Rearbrake Disc</b> 37.BD22202 '15-18 37.BD22418 '19-21 37.BD22420 '22-23  <b>Front Pad Set</b> 37.105802 '15-21 37.105802BX '15-21 Box of 10 37.180302 '22-23 37.180302BX '22-23 Box of 10  <b>Rear Pad Set</b> 37.201302 '15-23 37.201302BX '15-23 Box of 10  <b>Front Caliper Rebuild Kit</b> 37.63011 '15-23  <b>Rear Caliper Rebuild Kit</b> 37.63032 '15-23  <b>Front Master Cylinder Rebuild Kit</b> 37.910010 '15-23  <b>Rear Master Cylinder Rebuild Kit</b> 37.910019 '15-23	<b>Front Sprocket</b> 07.FS22005-12 07.FS22005-13 07.FS22005-14 07.FS22005-15 '15-23  <b>7075-T6 Alloy Rear Sprocket</b> 07.RA22099-47 07.RA22099-48 07.RA22099-49 07.RA22099-50 07.RA22099-51 07.RA22099-52 '15-23  <b>Ultraight Steel Rear Sprocket</b> 07.RS22099R-47 07.RS22099R-48 07.RS22099R-49 07.RS22099R-50 07.RS22099R-51 07.RS22099R-52 '15-23  <b>Sprocket Bolt Set</b> 07.SBSM825 '15-23	<b>Chain</b> 07.RC520120C '15-23 MX 07.RC520120CG '15-23 MX Gold 07.RC520120XC '15-23 X-Ring 07.RC520120XCG '15-23 X-Ring Gold  <b>Countershaft Seal Kit</b> 26.640044 '15-23  <b>Lower Chain Roller</b> 33.0007 '15-19  <b>Upper Chain Roller</b> 33.0008 '15-23	<b>Swingarm</b> 26.210202 '15-23  <b>Linkage</b> 26.110171 '15-23  <b>Upper</b> 26.310016 '15-23  <b>Lower</b> 26.450015 '15-23	<b>Seal &amp; Wiper</b> 40.S485810 '15-23  <b>Oil Seal Set</b> 40.F485810 '15-23  <b>Dust Seal Set</b> 40.F4858D '15-23  <b>Bushing Set</b> 39.160068 '15 39.160126 '16-18  <b>Rear Shock Seal Head Kit</b> 26.810001 '15-20
---	--	---	--	--	---	---	---	--

DIRT  
APRILIA  
BETA  
BMW  
GAS GAS  
HONDA  
HUSABERG  
HUSQVARNA  
KAWASAKI  
KTM  
MOTO TM  
RIEJU  
SHERCO  
SUZUKI  
YAMAHA

STREET  
APRILIA  
CAGIVA  
HONDA  
KAWASAKI  
KTM  
SUZUKI  
YAMAHA

ATV-UTV  
CAN-AM  
GAS GAS  
HONDA  
KAWASAKI  
KTM  
POLARIS  
SUZUKI  
YAMAHA

PWC  
KAWASAKI  
POLARIS  
SEA DOO  
YAMAHA

SNOW  
ARCTIC CAT  
KAWASAKI  
LYNX  
MOTO-SKI  
POLARIS  
SKI DOO  
YAMAHA

MOPED & SCOOTER

MISC. TECH. SPECIAL





**YAMAHA**

**DIRT**

**STREET**

**ATV-UTV**

**PWC**

**SNOW**

**MOPED & SCOOTER**

**MISC. TECH. SPECIAL**

	<b>Piston Kit</b>	<b>SIZES (mm)</b>	<b>Piston Parts</b>	<b>CRANKSHAFT PARTS</b>	<b>CONNECTING ROD PARTS</b>	<b>GASKETS</b>	<b>VALVE TRAIN PARTS I</b>	<b>VALVE TRAIN PARTS II</b>
WR 250 F 4-Stroke Please Note: Nikasil Piston Size -Std. Compression 12.5:1 -Forged Piston	01.2406.A 01.2406.B 01.2406.C & 01.2401.200 '01-13	76.95 76.96 76.97	02.2402 02.2402 02.2402	<b>Crank Bearing &amp; Seal Kit</b> 23.CBS24001* '01-23	<b>Con. Rod Kit</b> 03.2401 '01-02 03.2403 '03-13 03.2414 '15-23	<b>Complete</b> 34.2401 '01-02 34.2403 '03-13 34.2414 '15-19	<b>Cam Chain</b> 31.2402 '01-13 31.2414 '15-23	<b>Valve</b> 28.2401-1 '01-13 2x Exhaust Titanium 28.2401-2 '01-13 1x Intake I Titanium 28.2401-3 '01-13 2x Intake II Titanium 28.2414-1 '15-23 2x Exhaust Titanium 28.2414-2 '15-19 2x Intake Titanium 28.2419-2 '20-23 2x Intake Titanium
Please Note: Nikasil Piston Size -Std. Compression 13.5:1 -Forged Piston -Fuel Injection	01.2414.A 01.2414.B 01.2414.C '15-17	76.95 76.96 76.97	02.3340 02.3340 02.3340	<b>Bearing</b> 23.830046-1 '01-23 2x	<b>B/E Bearing</b> 22.303818F '01-02 22.324018F '03-13 22.303818F-1 '15-23	<b>Top-End</b> 35.2401 '01-13 35.2414 '15-19 35.2419 '20-23	<b>Valve Shim Assortment</b> 29.VSA748 '01-13 29.VSA748-2 '01-13 29.VSA948 '15-23 29.VSA948-2 '15-23	<b>TI-Steel Conversion Kit</b> 28.SES2402-1 '01-13 Exhaust 28.SIS2402-2 '01-13 Intake 28.SES2414-1 '15-19 Exhaust 28.SIS2414-2 '15-19 Intake
Please Note: Nikasil Piston Size -Std. Compression 13.5:1 -Forged Piston -Fuel Injection	01.2417.A 01.2417.B 01.2417.C '18-19	76.95 76.96 76.97	02.3340 02.3340 02.3340	<b>Crankpin</b> 06.3054.8 '01-02 06.3254.8 '03-13 06.3054.8-1 '15-23	<b>Head &amp; Base</b> 36.2301 '01-13 36.2314 '15-19 36.2319 '20-23	<b>Ignition Cover Gasket</b> 19.G92401 '01-02 19.G92403 '03-13 19.G92314 '15-19	<b>Valve Seal</b> 35.VS011 '01-13 3x Intake 35.VS012 '01-13 2x Exhaust 35.VS013 '15-23 2x Intake 35.VS027 '15-23 2x Exhaust	
Please Note: Nikasil Piston Size -Std. Compression 13.8:1 -Forged Piston -Fuel Injection	01.2439.A 01.2439.B 01.2439.C '20-23	76.95 76.96 76.97	02.3340 02.3340 02.3340	<b>Washers</b> 03W.30501.0 '16-23 2x	<b>Pin</b> 04.1644.4 '01-13 <b>Clips</b> 05.1612C '01-23			

Footnotes: \* Bearings Only \*\* Rubbers included

<b>Air Filter</b> 52.22097 '01-02 52.23003 '03-13 52.24014 '15-19 52.24018 '20-23	<b>Basket</b> 17.2401F '01-13	<b>Complete Plate Set</b> 16.CPS23001 '01-13 16.S23049 '15-19	<b>F/W Bearing</b> 23.S116032 '01-19 23.S114082 '20-23	<b>Frontbrake Disc</b> 37.BD13288 '01-16 37.BD12416 '17-21	<b>Front Sprocket</b> 07.FS22005-12 07.FS22005-13 07.FS22005-14 07.FS22005-15 '01-23	<b>Chain</b> 07.RC520120C '01-23 MX 07.RC520120CG '01-23 MX Gold 07.RC520120XC '01-23 X-Ring 07.RC520120XCG '01-23 X-Ring Gold	<b>Swingarm</b> 26.210073 '01 26.210072 '02-05 26.210158 '06-13 26.210202 '15-23	<b>Seal &amp; Wiper</b> 40.S46589 '01-04 40.S485810 '05-23
<b>Main Jet</b> 45.100-225 '01-13 Keihin	<b>Spring Kit</b> 17.CS23034 '01-13	<b>Friction Set</b> 16.S23017 '01-14 16.S23049 '15-19 16.S23065 '20-23	<b>R/W Bearing</b> 23.S112052 '01-23	<b>Rearbrake Disc</b> 37.BD22202 '02-18 37.BD22418 '19-23	<b>7075-T6 Alloy Rear Sprocket</b> 07.RA22099-47 07.RA22099-48 07.RA22099-49 07.RA22099-50 07.RA22099-51 07.RA22099-52 '01-23	<b>Countershaft Seal Kit</b> 26.640020 '01-13 26.640044 '15-23	<b>Linkage</b> 26.110067 '01 26.110065 '02-04 26.110128 '05	<b>Dust Seal Set</b> 40.F4658D '01-04 40.F485810 '05-23
<b>Pilot Jet</b> 46.040-085 '01-13 Keihin	<b>Cover</b> 19.2401 '01-13	<b>Steel Set</b> 16.S23018 '01-19 16.S43025 '20-23	<b>F/W Spacer Kit</b> 26.710073 '02-04 26.710074 '05-19 26.710104 '20-23	<b>Front Pad Set</b> 37.103202 '01-16 37.103202BX '01-16 Box of 10 37.105802 '17-21 37.105802BX '17-21 Box of 10 37.180302 '22-23 37.180302BX '22-23 Box of 10	<b>UltraLight Steel Rear Sprocket</b> 07.RS22099R-47 07.RS22099R-48 07.RS22099R-49 07.RS22099R-50 07.RS22099R-51 07.RS22099R-52 '01-23	<b>Lower Chain Roller</b> 33.0007 '01-19	<b>Bushing Set</b> 39.160010 '01-03 39.160045 '04 39.160036 '05 39.160050 '06-14 39.160068 '15-17 39.160126 '18-19	
<b>Carburetor Rebuild Kit</b> 55.10302 '01 55.10302 '03 55.10301 '04 55.10299 '05 55.10294 '06-13	<b>Cover Gasket</b> 19.G2301 '01-13 19.G2314 '15-19	<b>Clutch Cable</b> 53.120024 '01-14 53.121038 '15-19 53.121052 '20-21	<b>R/W Spacer Kit</b> 26.710080 '01 26.710081 '02-23	<b>Rear Pad Set</b> 37.207102 '01-02 37.207102BX '01-02 Box of 10 37.201302 '03-23 37.201302BX '03-23 Box of 10	<b>Sprocket Bolt Set</b> 07.SBSM825 '01-23	<b>Upper Chain Roller</b> 33.0008 '01-23	<b>Rear Shock Seal Head Kit</b> 26.810002 '01-14 26.810001 '15-20	
<b>Throttle Cable</b> 53.111078 '01-02 53.111076 '03-06 53.111072 '07-13 53.110251 '15-19 53.112079 '20-23	<b>Oil Filter</b> 54.23142 '01-02 1-Pce. 54.23142-50 '01-02 50-Pcs. 54.23140 '03-23 1-Pce. 54.23140-50 '03-23 50-Pcs.	<b>Water Pump Rebuild Kit</b> 57.2320 '01-13 57.2324 '15-19	<b>Steering Bearing</b> 24.110001 '01-23	<b>Rear Caliper Rebuild Kit</b> 37.63028 '01-02 37.63032 '03-23	<b>Front Master Cylinder Rebuild Kit</b> 37.910002 '01-16 37.910010 '17-23	<b>Rear Master Cylinder Rebuild Kit</b> 37.910007 '01-02 37.910019 '03-23		

**DIRT**

**STREET**

**ATV-UTV**

**PWC**

**SNOW**

**MOPED & SCOOTER**

**MISC. TECH. SPECIAL**



**YAMAHA**

**DIRT**

YZ 400 F 4-Stroke Please Note: Nikasil Piston Size -Std. Compression 12.5:1 -Forged Piston	<b>Piston Kit</b> 01.2419.A 01.2419.B 01.2419.C '98-99	<b>Size (mm)</b> 91.95 91.96 91.97	<b>Ring Set</b> 02.2419 02.2419 02.2419 '98-99	<b>CrankBearing &amp; Seal Kit</b> 23.CBS24098* '98-99	<b>Con. Rod Kit</b> 03.2400 '98-99	<b>Complete</b> 34.2418 '98-99	<b>Cam Chain</b> 31.2419 '98-99	<b>Valve</b> 28.2418-1 '98-99 2x Exhaust Steel 28.2418-2 '98-99 1x Intake I Steel 28.2418-3 '98-99 2x Intake II Steel
			<b>Clips</b> 05.1812 '98-99	<b>Bearing</b> 23.83C072C '98-99 2x	<b>B/E Bearing</b> 22.344220F '98-99	<b>Top-End</b> 35.2418 '98-99	<b>Valve Shim Assortment</b> 29.VSA948 '98-99	<b>Valve Seal</b> 35.VS012 '98-99 3x Intake 35.VS013 '98-99 2x Exhaust
					<b>Crankpin</b> 06.3460.8 '98-99	<b>Ignition Cover Gasket</b> 19.G92498 '98-99		

**STREET**

APRILIA  
BETA  
BMW  
GAS GAS  
HONDA  
HUSABERG  
HUSQVARNA  
KAWASAKI  
KTM  
MOTO TM  
RIEJU  
SHERCO  
SUZUKI  
YAMAHA

**ATV-UTV**

WR 400 F 4-Stroke Please Note: Nikasil Piston Size -Std. Compression 12.5:1 -Forged Piston	<b>Piston Kit</b> 01.2419.A 01.2419.B 01.2419.C '98-00	<b>Size</b> 91.95 91.96 91.97	<b>Ring Set</b> 02.2419 02.2419 02.2419 '98-00	<b>CrankBearing &amp; Seal Kit</b> 23.CBS24098* '98-00	<b>Con. Rod Kit</b> 03.2400 '98-00	<b>Complete</b> 34.2418 '98-99 34.2420 '00	<b>Cam Chain</b> 31.2419 '98-00	<b>Valve</b> 28.2418-1 '98-00 2x Exhaust Steel 28.2418-2 '98-00 1x Intake I Steel 28.2418-3 '98-00 2x Intake II Steel
			<b>Clips</b> 05.1812 '98-00	<b>Bearing</b> 23.83C072C '98-00 2x	<b>B/E Bearing</b> 22.344220F '98-00	<b>Top-End</b> 35.2418 '98-99 35.2420 '00	<b>Valve Shim Assortment</b> 29.VSA948 '98-00	<b>Valve Seal</b> 35.VS012 '98-00 3x Intake 35.VS013 '98-00 2x Exhaust
					<b>Crankpin</b> 06.3460.8 '98-00	<b>Ignition Cover Gasket</b> 19.G92498 '98-00		

**PWC**

KAWASAKI  
POLARIS  
SEA DOO  
YAMAHA

**SNOW**

ARCTIC CAT  
KAWASAKI  
LYNX  
MOTO-SKI  
POLARIS  
SKI DOO  
YAMAHA

**MOPED & SCOOTER**

**MISC. TECH. SPECIAL**

Footnotes: \* Bearings Only \*\* Rubbers included

<b>Air Filter</b> 52.22097 '98-99	<b>Basket</b> 17.2404F '98-99	<b>Friction Set</b> 16.S24019 '98-99	<b>F/W Bearing</b> 23.S110092 '98-99	<b>Front Pad Set</b> 37.103202 '98-99 37.103202BX '98-99 Box of 10	<b>Front Sprocket</b> 07.FS23099-13 07.FS23099-14 07.FS23099-15 '98-99	<b>Chain</b> 07.RC520120C '98-99 MX 07.RC520120CG '98-99 MX Gold 07.RC520120XC '98-99 X-Ring 07.RC520120XCG '98-99 X-Ring Gold	<b>Swingarm</b> 26.210076 '98 26.210073 '99	<b>Seal &amp; Wiper</b> 40.S46589 '98-99
<b>Main Jet</b> 45.100-225 '98-99 Keihin	<b>Spring Kit</b> 17.CS24035 '98-99		<b>R/W Bearing</b> 23.S112071 '98 23.S112052 '99	<b>Rear Pad Set</b> 37.201202 '98 37.201202BX '98 Box of 10 37.207102 '99 37.207102BX '99 Box of 10	<b>7075-T6 Alloy Rear Sprocket</b> 07.RA22099-47 07.RA22099-48 07.RA22099-49 07.RA22099-50 07.RA22099-51 07.RA22099-52 '98-99	<b>Lower Chain Roller</b> 33.0007 '98-99	<b>Linkage</b> 26.110088 '98-99	<b>Oil Seal Set</b> 40.F46589 '98-99
<b>Pilot Jet</b> 46.040-085 '98-99 Keihin	<b>Cover Gasket</b> 19.G2498 '98-99		<b>F/W Spacer Kit</b> 26.710069 '98-99	<b>Front Caliper Rebuild Kit</b> 37.63005 '98-00	<b>Ultralight Steel Rear Sprocket</b> 07.RS22099R-47 07.RS22099R-48 07.RS22099R-49 07.RS22099R-50 07.RS22099R-51 07.RS22099R-52 '98-99	<b>Countershaft Seal Kit</b> 26.640019 '98-99	<b>Upper</b> 26.310016 '98-99	<b>Dust Seal Set</b> 40.F4658D '98-99
<b>Carburetor Rebuild Kit</b> 55.10443 '98-99			<b>R/W Spacer Kit</b> 26.710079 '98 26.710080 '99	<b>Rear Caliper Rebuild Kit</b> 37.63004 '99-00	<b>Sprocket Bolt Set</b> 07.SBSM825 '98-99	<b>Lower Chain Roller</b> 33.0008 '98-99	<b>Lower</b> 26.450016 '98-99	<b>Bushing Set</b> 39.160010 '98-99
<b>Throttle Cable</b> 53.111081 '98-99			<b>Steering Bearing</b> 24.110001 '98-99	<b>Front Master Cylinder Rebuild Kit</b> 37.910016 '98-99		<b>Upper Chain Roller</b> 33.0008 '98-99	<b>Rear Shock Seal Head Kit</b> 26.810002 '98-99	
<b>Oil Filter</b> 54.23142 '98-99 1-Pce. 54.23142-50 '98-99 50-Pcs.				<b>Rear Master Cylinder Rebuild Kit</b> 37.910003 '98-99				
<b>Water Pump Rebuild Kit</b> 57.2418 '98-99								

APRILIA  
BETA  
BMW  
GAS GAS  
HONDA  
HUSABERG  
HUSQVARNA  
KAWASAKI  
KTM  
MOTO TM  
RIEJU  
SHERCO  
SUZUKI  
YAMAHA

<b>Air Filter</b> 52.22097 '98-00	<b>Basket</b> 17.2404F '98-00	<b>Friction Set</b> 16.S24019 '98-00	<b>F/W Bearing</b> 23.S116032 '98-00	<b>Front Pad Set</b> 37.103202 '98-00 37.103202BX '98-00 Box of 10	<b>Front Sprocket</b> 07.FS23099-13 07.FS23099-14 07.FS23099-15 '98-00	<b>Chain</b> 07.RC520120C '98-00 MX 07.RC520120CG '98-00 MX Gold 07.RC520120XC '98-00 X-Ring 07.RC520120XCG '98-00 X-Ring Gold	<b>Swingarm</b> 26.210076 '98 26.210073 '99-00	<b>Seal &amp; Wiper</b> 40.S46589 '98-00
<b>Main Jet</b> 45.100-225 '98-00 Keihin	<b>Spring Kit</b> 17.CS24035 '98-00		<b>R/W Bearing</b> 23.S112071 '98 23.S112052 '99-00	<b>Rear Pad Set</b> 37.201202 '98 37.201202BX '98 Box of 10 37.207102 '99-00 37.207102BX '99-00 Box of 10	<b>7075-T6 Alloy Rear Sprocket</b> 07.RA22099-47 07.RA22099-48 07.RA22099-49 07.RA22099-50 07.RA22099-51 07.RA22099-52 '98-00	<b>Countershaft Seal Kit</b> 26.640019 '98-00	<b>Upper</b> 26.310016 '98-00	<b>Oil Seal Set</b> 40.F46589 '98-00
<b>Pilot Jet</b> 46.040-085 '98-00 Keihin	<b>Cover Gasket</b> 19.G2498 '98-99 19.G2490 '00		<b>F/W Spacer Kit</b> 26.710079 '98 26.710080 '99-00	<b>Front Caliper Rebuild Kit</b> 37.63005 '98-00	<b>Ultralight Steel Rear Sprocket</b> 07.RS22099R-47 07.RS22099R-48 07.RS22099R-49 07.RS22099R-50 07.RS22099R-51 07.RS22099R-52 '98-00	<b>Lower Chain Roller</b> 33.0008 '98 33.0007 '99-00	<b>Upper</b> 26.310016 '98-00	<b>Dust Seal Set</b> 40.F4658D '98-00
<b>Carburetor Rebuild Kit</b> 55.10324 '98-99 55.10323 '00	<b>Clutch Cable</b> 53.120024 '00		<b>Steering Bearing</b> 24.110001 '98-00	<b>Rear Caliper Rebuild Kit</b> 37.63035 '98 37.63028 '99-00	<b>Sprocket Bolt Set</b> 07.SBSM825 '98-00	<b>Lower Chain Roller</b> 33.0008 '98 33.0007 '99-00	<b>Lower</b> 26.450016 '98-00	<b>Bushing Set</b> 39.160010 '98-00
<b>Throttle Cable</b> 53.111081 '98-99 53.111078 '00				<b>Front Master Cylinder Rebuild Kit</b> 37.910016 '98-00		<b>Upper Chain Roller</b> 33.0007 '98 33.0008 '99-00	<b>Rear Shock Seal Head Kit</b> 26.810002 '98-00	
<b>Oil Filter</b> 54.23142 '98-00 1-Pce. 54.23142-50 '98-00 50-Pcs.				<b>Rear Master Cylinder Rebuild Kit</b> 37.910003 '98-99 37.910007 '00				
<b>Water Pump Rebuild Kit</b> 57.2418 '98-00								

KAWASAKI  
POLARIS  
SEA DOO  
YAMAHA

ARCTIC CAT  
KAWASAKI  
LYNX  
MOTO-SKI  
POLARIS  
SKI DOO  
YAMAHA

Footnotes: \* Bearings Only \*\* Rubbers included



**PISTON KITS**



**SIZES (mm)**



**PISTON PARTS**



**CRANKSHAFT PARTS**



**CONNECTING ROD PARTS**



**GASKETS**



**VALVE TRAIN PARTS I**



**VALVE TRAIN PARTS II**



**AIR & FUEL PARTS**



**CLUTCH PARTS**



**CLUTCH PLATE SETS**



**WHEEL & STEERING PARTS**



**BRAKE PARTS**



**DRIVE CHAIN PARTS I**



**DRIVE CHAIN PARTS II**



**SUSPENSION BEARING KITS**



**SUSPENSION PARTS**



**SUSPENSION PARTS**



**DIRT**

**YAMAHA**

<b>DIRT</b> YZ 426 F 4-Stroke Please Note: Nikasil Piston Size -Std. Compression 12.5:1 -Forged Piston	<b>Piston Kit</b> 01.2427.A 01.2427.B 01.2427.C & 01.2421.200 '00-02	<b>Size</b> 94.95 94.96 94.97 97.00	<b>Ring Set</b> 02.6419 02.6419 02.6419 -	<b>Crank Bearing &amp; Seal Kit</b> 23.CBS24098* '00-02  <b>Bearing</b> 23.83C072C '00-02 2x	<b>Con. Rod Kit</b> 03.2420 '00-02  <b>B/E Bearing</b> 22.344220F '00-02  <b>Crankpin</b> 06.3460.8 '00-02	<b>Complete</b> 34.2420 '00-02  <b>Top-End</b> 35.2420 '00-02  <b>Ignition Cover Gasket</b> 19.G92498 '00-02	<b>Cam Chain</b> 31.2419 '00-02  <b>Valve Shim Assortment</b> 29.VSA948 '00-02 29.VSA948-2 '00-02	<b>Valve</b> 28.2418-1 '00 2x Exhaust Steel 28.2420-1 '01-02 2x Exhaust Titanium 28.2418-2 '00 1x Intake I Steel 28.2418-3 '00 2x Intake I Steel 28.2420-2 '01-02 1x Intake II Titanium 28.2420-3 '01-02 2x Intake II Titanium  <b>Valve Seal</b> 35.VS012 '00-02 3x Intake 35.VS013 '00-02 2x Exhaust
	<b>Clips</b> 05.1912 '00-02							
<b>STREET</b> WR 426 F 4-Stroke Please Note: Nikasil Piston Size -Std. Compression 12.5:1 -Forged Piston	<b>Piston Kit</b> 01.2427.A 01.2427.B 01.2427.C & 01.2421.200 '01-02	<b>Size</b> 94.95 94.96 94.97 97.00	<b>Ring Set</b> 02.6419 02.6419 02.6419 -	<b>Crank Bearing &amp; Seal Kit</b> 23.CBS24098* '01-02  <b>Bearing</b> 23.83C072C '01-02 2x	<b>Con. Rod Kit</b> 03.2420 '01-02  <b>B/E Bearing</b> 22.344220F '01-02  <b>Crankpin</b> 06.3460.8 '01-02	<b>Complete</b> 34.2420 '01-02  <b>Top-End</b> 35.2420 '01-02  <b>Ignition Cover Gasket</b> 19.G92498 '01-02	<b>Cam Chain</b> 31.2419 '01-02  <b>Valve Shim Assortment</b> 29.VSA948 '01-02 29.VSA948-2 '01-02	<b>Valve</b> 28.2420-1 '01-02 2x Exhaust Titanium 28.2420-2 '01-02 1x Intake I Titanium 28.2420-3 '01-02 2x Intake II Titanium  <b>Valve Seal</b> 35.VS012 '01-02 3x Intake 35.VS013 '01-02 2x Exhaust
	<b>Clips</b> 05.1912 '01-02							
<b>ATV-UTV</b> KAWASAKI POLARIS SEA DOO YAMAHA								
<b>PWC</b> KAWASAKI POLARIS SEA DOO YAMAHA								
<b>SNOW</b> ARCTIC CAT KAWASAKI LYNX MOTO-SKI POLARIS SKI DOO YAMAHA								
<b>MOPED &amp; SCOOTER</b>								
<b>MISC. TECH. SPECIAL</b>								

Footnotes: \* Bearings Only \*\* Rubbers included

<b>Air Filter</b> 52.22097 '00-02	<b>Basket</b> 17.2406 '00 17.2407F '01-02	<b>Complete Plate Set</b> 16.CPS24000 '00 16.CPS24001 '01-02	<b>F/W Bearing</b> 23.S110092 '00-02	<b>Frontbrake Disc</b> 37.BD13288 '00-02	<b>Front Sprocket</b> 07.FS23099-13 07.FS23099-14 07.FS23099-15 '00-02	<b>Chain</b> 07.RC520120C '00-02 MX 07.RC520120CG '00-02 MX Gold 07.RC520120XC '00-02 X-Ring 07.RC520120XCG '00-02 X-Ring Gold	<b>Swingarm</b> 26.210073 '00-01 26.210072 '02	<b>Seal &amp; Wiper</b> 40.S46589 '00-02
<b>Main Jet</b> 45.100-225 '00-02 Keihin	<b>Spring Kit</b> 17.CS24039 '00 17.CS23033 '01-02	<b>Friction Set</b> 16.S24020 '00 16.S24022 '01-02	<b>R/W Bearing</b> 23.S112052 '00-02	<b>Rearbrake Disc</b> 37.BD22202 '02	<b>7075-T6 Alloy Rear Sprocket</b> 07.RA22099-47 07.RA22099-48 07.RA22099-49 07.RA22099-50 07.RA22099-51 07.RA22099-52 '00-02	<b>Linkage</b> 26.110088 '00 26.110067 '01 26.110065 '02	<b>Oil Seal Set</b> 40.F46589 '00-02	
<b>Pilot Jet</b> 46.040-085 '00-02 Keihin	<b>Cover Gasket</b> 19.G2498 '00-02	<b>Steel Set</b> 16.S24021 '00-02	<b>F/W Spacer Kit</b> 26.710069 '00-01 26.710070 '02	<b>Front Pad Set</b> 37.103202 '00-02 37.103202BX '00-02 Box of 10	<b>UltraLight Steel Rear Sprocket</b> 07.RS22099R-47 07.RS22099R-48 07.RS22099R-49 07.RS22099R-50 07.RS22099R-51 07.RS22099R-52 '00-02	<b>Dust Seal Set</b> 40.F4658D '00-02	<b>Upper</b> 26.310016 '00-02	
<b>Carburetor Rebuild Kit</b> 55.10439 '00-02	<b>Clutch Cable</b> 53.120024 '00-02		<b>R/W Spacer Kit</b> 26.710080 '00-01 26.710081 '02	<b>Rear Pad Set</b> 37.207102 '00-02 37.207102BX '00-02 Box of 10	<b>Rear Sprocket Bolt Set</b> 07.SBSM825 '00-02	<b>Bushing Set</b> 39.160010 '00-02	<b>Rear Shock Seal Head Kit</b> 26.810002 '00-02	
<b>Throttle Cable</b> 53.111078 '00-02			<b>Steering Bearing</b> 24.110001 '00-02	<b>Front Caliper Rebuild Kit</b> 37.63005 '00-02				
<b>Oil Filter</b> 54.23142 '00-02 1-Pce. 54.23142-50 '00-02 50-Pcs.				<b>Rear Caliper Rebuild Kit</b> 37.63004 '00-02				
<b>Water Pump Rebuild Kit</b> 57.2418 '00-02				<b>Front Master Cylinder Rebuild Kit</b> 37.910016 '00 37.910002 '01-02				
				<b>Rear Master Cylinder Rebuild Kit</b> 37.910007 '00-02				
<b>Air Filter</b> 52.22097 '01-02	<b>Spring Kit</b> 17.CS23033 '01-02	<b>Friction Set</b> 16.S24022 '01-02	<b>F/W Bearing</b> 23.S116032 '01-02	<b>Frontbrake Disc</b> 37.BD13288 '01-02	<b>Front Sprocket</b> 07.FS23099-13 07.FS23099-14 07.FS23099-15 '01-02	<b>Chain</b> 07.RC520120C '01-02 MX 07.RC520120CG '01-02 MX Gold 07.RC520120XC '01-02 X-Ring 07.RC520120XCG '01-02 X-Ring Gold	<b>Swingarm</b> 26.210073 '01 26.210072 '02	<b>Seal &amp; Wiper</b> 40.S46589 '01-02
<b>Main Jet</b> 45.100-225 '01-02 Keihin	<b>Cover Gasket</b> 19.G2490 '01-02		<b>R/W Bearing</b> 23.S112052 '01-02	<b>Rearbrake Disc</b> 37.BD22202 '02	<b>7075-T6 Alloy Rear Sprocket</b> 07.RA22099-47 07.RA22099-48 07.RA22099-49 07.RA22099-50 07.RA22099-51 07.RA22099-52 '01-02	<b>Linkage</b> 26.110067 '01 26.110065 '02	<b>Oil Seal Set</b> 40.F46589 '01-02	
<b>Pilot Jet</b> 46.040-085 '01-02 Keihin	<b>Clutch Cable</b> 53.120024 '01-02		<b>F/W Spacer Kit</b> 26.710073 '02 26.710080 '01 26.710081 '02	<b>Front Pad Set</b> 37.103202 '01-02 37.103202BX '01-02 Box of 10	<b>UltraLight Steel Rear Sprocket</b> 07.RS22099R-47 07.RS22099R-48 07.RS22099R-49 07.RS22099R-50 07.RS22099R-51 07.RS22099R-52 '01-02	<b>Dust Seal Set</b> 40.F4658D '01-02	<b>Upper</b> 26.310016 '01-02	
<b>Carburetor Rebuild Kit</b> 55.10441 '01-02			<b>R/W Spacer Kit</b> 26.710080 '01 26.710081 '02	<b>Rear Pad Set</b> 37.207102 '01-02 37.207102BX '01-02 Box of 10	<b>Rear Sprocket Bolt Set</b> 07.SBSM825 '01-02	<b>Bushing Set</b> 39.160010 '01-02	<b>Rear Shock Seal Head Kit</b> 26.810002 '01-02	
<b>Throttle Cable</b> 53.111078 '01-02			<b>Steering Bearing</b> 24.110001 '01-02	<b>Front Caliper Rebuild Kit</b> 37.63005 '01-02				
<b>Oil Filter</b> 54.23142 '01-02 1-Pce. 54.23142-50 '01-02 50-Pcs.				<b>Rear Caliper Rebuild Kit</b> 37.63004 '01-02				
<b>Water Pump Rebuild Kit</b> 57.2418 '01-02				<b>Front Master Cylinder Rebuild Kit</b> 37.910002 '01-02				
				<b>Rear Master Cylinder Rebuild Kit</b> 37.910007 '01-02				



### YAMAHA

DIRT	Piston Kit	Size	Ring Set	Crank Bearing & Seal Kit	Con. Rod Kit	Complete	Cam Chain	Valve
YZ 450 F 4-Stroke	01.2429.A	94.95	02.2421	23.CBS24098*	03.2423	34.2423	31.2423	28.2423-1
APRILIA BETA BMW GAS GAS HONDA HUSABERG HUSQVARNA KAWASAKI KTM MOTO TM RIEJU SHERCO SUZUKI YAMAHA	01.2429.B 01.2429.C & 01.2424.200 '03-09	94.96 94.97 97.00	02.2421 02.2421 -	'03-09	'03-05 03.2426 '06-09 03.2440 '10-19 03.2450 '20-22	34.2426 34.2426 34.2440 34.2454 34.2423	'03-09 31.4409 '10-19 31.2423 '20-22	'03-09 2x Exhaust Titanium 28.2423-2 Titanium 28.2423-3 Titanium 28.2440-1 Titanium 28.2440-1 Titanium 28.2440-2 Titanium 28.2444-1 Titanium 28.2444-2 Titanium 28.2450-1 Titanium 28.2450-2 Titanium 28.2453-1 Titanium 28.2453-2 Titanium 28.2450-1 Titanium 28.2450-2 Titanium 28.2453-1 Titanium 28.2453-2 Titanium
Please Note: Nikasil Piston Size -Std. Compression 12.5:1 -Forged Piston -Fuel Injection	01.2440.A 01.2440.B 01.2440.C '10-13	96.95 96.96 96.97	02.2440 02.2440 02.2440	03.2450 '20-22	22.344220F '03-09 22.344221F '10-22	35.2423 35.2426 35.2440 35.2448 35.2450 36.2403 36.2406 36.2410 36.2414 36.2418 36.2450 '20-22	29.VSA948 '03-23 29.VSA948-2 '03-23	'03-09 2x Intake I Titanium 28.2440-1 Titanium 28.2440-2 Titanium 28.2444-1 Titanium 28.2444-2 Titanium 28.2450-1 Titanium 28.2450-2 Titanium 28.2453-1 Titanium 28.2453-2 Titanium 28.2450-1 Titanium 28.2450-2 Titanium 28.2453-1 Titanium 28.2453-2 Titanium
Head & Base	01.2444.A 01.2444.B 01.2444.C '14-17	96.95 96.96 96.97	02.6427 02.6427 02.6427	06.3460.8 '03-22		36.2403 '03-05 36.2406 '06-09 36.2410 '10-13 36.2414 '14-17 36.2418 '18-19 36.2450 '20-22		TI-Steel Conversion Set 28.SES2424-1 '03-09 Exhaust 28.SIS2424-2 '03-09 Intake 28.SES2440-1 '10-13 Exhaust 28.SIS2440-2 '10-13 Intake 28.SES2444-1 '14-15 Exhaust 28.SIS2444-2 '14-17 Intake
Please Note: Nikasil Piston Size -Std. Compression 12.5:1 -Forged Piston -Fuel Injection	01.2448.A 01.2448.B 01.2448.C '18-19	96.95 96.96 96.97	02.2440 02.2440 02.2440			36.2403 '03-05 36.2406 '06-09 36.2410 '10-13 36.2414 '14-17 36.2418 '18-19 36.2450 '20-22		
Please Note: Nikasil Piston Size -Std. Compression 12.8:1 -Forged Piston -Fuel Injection	01.2450.A 01.2450.B 01.2450.C '20-22	96.95 96.96 96.97	02.2440 02.2440 02.2440			36.2403 '03-05 36.2406 '06-09 36.2410 '10-13 36.2414 '14-17 36.2418 '18-19 36.2450 '20-22		
Please Note: Nikasil Piston Size -Std. Compression 13.0:1 -Forged Piston -Fuel Injection	01.2453.A 01.2453.B 01.2453.C '23	96.95 96.96 96.97	02.2440 02.2440 02.2440			36.2403 '03-05 36.2406 '06-09 36.2410 '10-13 36.2414 '14-17 36.2418 '18-19 36.2450 '20-22		
High Compression	01.2441.A 01.2441.B '10-13	96.95 96.96	02.2440 02.2440			36.2403 '03-05 36.2406 '06-09 36.2410 '10-13 36.2414 '14-17 36.2418 '18-19 36.2450 '20-22		
Replating or Cylinder Sleaving Required for Oversizes						36.2403 '03-05 36.2406 '06-09 36.2410 '10-13 36.2414 '14-17 36.2418 '18-19 36.2450 '20-22		
Pin			04.1844.4 '10-17					
Clips			05.1814 '03-09 05.1812 '10-23					

Footnotes: \* Bearings Only \*\* Rubbers included

Air Filter	Basket	Complete Plate Set	F/W Bearing	Frontbrake Disc	Front Sprocket	Chain	Swingarm	Seal & Wiper
52.22097 '03-09 52.24010 '10-13 52.24014 '14-17 52.24018 '18-22 52.24023 '23	17.2423 * '03 17.2424F * '04-22	16.CPS24003 '03-06 16.CPS24007 '07-13 16.CPS24014 '14-17 16.CPS24023 '23	23.S110092 '03-13 23.S114082 '14-23	37.BD13288 '03-15 37.BD12416 '16-23	07.FS23099-13 07.FS23099-14 07.FS23099-15 '03-23	07.RC520120C '03-23 MX 07.RC520120CG '03-23 MX Gold 07.RC520120XC '03-23 X-Ring 07.RC520120XCG '03-23 X-Ring Gold	26.210072 '03-05 26.210158 '06-09 26.210202 '10-23	40.S46589 '03 40.S485810 '04-23
Main Jet	Clutch Rubber Set	Friction Set	R/W Bearing	Rearbrake Disc	7075-T6 Alloy Rear Sprocket	Oil Seal Set	Linkage	Dust Seal Set
45.100-225 '03-09 Keihin	17.CS23033 '03-06 17.CS24036 '07-17	16.S24023 '03-06 16.S24041 '07-13 16.S24058 '14-22 16.S24066 '23	23.S112052 '03-08 23.S114006 '09-23	37.BD22202 '03-17 37.BD22418 '18-19 37.BD22420 '20-23	07.RA22099-47 07.RA22099-48 07.RA22099-49 07.RA22099-50 07.RA22099-51 07.RA22099-52 '03-23	40.F46589 '03 40.F485810 '04-23	26.110065 '03-04 26.110128 '05 26.110145 '06-08 26.110171 '09-23	40.F4658D '03 40.F4858D '04-23
Pilot Jet	Cover Gasket	Steel Set	F/W Spacer Kit	Front Pad Set	UltraLight Steel Rear Sprocket	Lower Chain Roller	Upper	Bushing Set
46.040-085 '03-09 Keihin	19.G2423 '03-09 19.G2440 '10-22	16.S24021 '03-06 16.S23016 '07-22 16.S24067 '23	26.710070 '03-07 26.710100 '08-13 26.710104 '14-18 26.710107 '19-23	37.103202 '03-07 37.103202BX '03-07 Box of 10 37.105802 '08-19 37.105802BX '08-19 Box of 10 37.180302 '20-23 37.180302BX '20-23 Box of 10	07.RS22099R-47 07.RS22099R-48 07.RS22099R-49 07.RS22099R-50 07.RS22099R-51 07.RS22099R-52 '03-23	33.0007 '03-17	26.310016 '03-23	39.160010 '03 39.160050 '04 39.160068 '05-09 39.160075 '10-18
Carburetor Rebuild Kit	Clutch Cable	R/W Spacer Kit	Steering Bearing	Rear Pad Set	Sprocket Bolt Set	Upper Chain Roller	Lower	Rear Shock Seal Head Kit
55.10272 '03-04 55.10271 '05-06 55.10270 '07-09	53.121014 '03 53.121008 '04-05 53.120021 '06-08 53.121013 '09 53.120020 '10-13 53.110250 '14-16 53.112056 '17 53.110265 '18-22 53.112092 '23	26.710081 '03-08 26.710099 '09-23	24.110001 '03-23	37.201302 '03-23 37.201302BX '03-23 Box of 10	07.SBSM825 '03-23	33.0008 '03-23	26.450015 '03-23	26.810002 '03-05 26.810117 '06-09 26.810001 '10-20
Oil Filter	Water Pump Rebuild Kit	Front Master Cylinder Rebuild Kit	Rear Master Cylinder Rebuild Kit					
54.23140 '03-23 1-Pce. 54.23140-50 '03-23 50-Pcs.	57.2423 '03-05 57.2426 '06-09 57.2420 '10-13 57.2424 '14-17	37.910002 '03-07 37.910010 '08-23	37.63005 '03-07 37.63011 '08-23 37.63032 '03-23					

**DIRT**  
APRILIA  
BETA  
BMW  
GAS GAS  
HONDA  
HUSABERG  
HUSQVARNA  
KAWASAKI  
KTM  
MOTO TM  
RIEJU  
SHERCO  
SUZUKI  
YAMAHA

**STREET**  
APRILIA  
CAGIVA  
HONDA  
KAWASAKI  
KTM  
SUZUKI  
YAMAHA

**ATV-UTV**  
CAN-AM  
GAS GAS  
HONDA  
KAWASAKI  
KTM  
POLARIS  
SUZUKI  
YAMAHA

**PWC**  
KAWASAKI  
POLARIS  
SEA DOO  
YAMAHA

**SNOW**  
ARCTIC CAT  
KAWASAKI  
LYNX  
MOTO-SKI  
POLARIS  
SKI DOO  
YAMAHA

**MOPED & SCOOTER**

**MISC. TECH. SPECIAL**

**DIRT**  
APRILIA  
BETA  
BMW  
GAS GAS  
HONDA  
HUSABERG  
HUSQVARNA  
KAWASAKI  
KTM  
MOTO TM  
RIEJU  
SHERCO  
SUZUKI  
YAMAHA

**STREET**  
APRILIA  
CAGIVA  
HONDA  
KAWASAKI  
KTM  
SUZUKI  
YAMAHA

**ATV-UTV**  
CAN-AM  
GAS GAS  
HONDA  
KAWASAKI  
KTM  
POLARIS  
SUZUKI  
YAMAHA

**PWC**  
KAWASAKI  
POLARIS  
SEA DOO  
YAMAHA

**SNOW**  
ARCTIC CAT  
KAWASAKI  
LYNX  
MOTO-SKI  
POLARIS  
SKI DOO  
YAMAHA

**MOPED & SCOOTER**

**MISC. TECH. SPECIAL**





### YAMAHA

#### DIRT

YZ 450 FX  
4-Stroke  
Please Note:  
Nikasil Piston Size  
-Std. Compression 12.5:1  
-Forged Piston  
-Fuel Injection

**Piston Kit**  
01.2444.A  
01.2444.B  
01.2444.C  
'16-18

**Size (mm)**  
96.95  
96.96  
96.97

**Ring Set**  
02.6427  
02.6427  
02.6427  
'16-18

**Crank Bearing & Seal Kit**  
23.CBS24098\*  
'16-23  
**Bearing**  
23.83C072C  
'16-23 2x

**Con. Rod Kit**  
03.2440  
'16-20  
03.2450  
'21-23  
**B/E Bearing**  
22.344221F  
'16-23  
**Crankpin**  
06.3460.8  
'16-23

**Complete**  
34.2454  
'16-18  
**Top-End**  
35.2424  
'16-18  
35.2448  
'19-20  
35.2450  
'21-23  
**Head & Base**  
36.2414  
'16-18  
36.2418  
'19-20  
36.2450  
'21-23  
**Ignition Cover Gasket**  
19.G92415  
'16-18

**Cam Chain**  
31.4409  
'16-20  
31.2423  
'21-23  
**Valve Shim Assortment**  
29.VSA948  
'16-23  
29.VSA948-2  
'16-23

**Valve**  
28.2444-1  
'16-20 2x Exhaust  
Titanium  
28.2444-2  
'16-20 2x Intake  
Titanium  
28.2450-1  
'19-20  
28.2450-2  
'21-23 2x Intake  
Titanium  
**TI-Steel Conversion Set**  
28.SIS2444-2  
'16-20 Intake  
**Valve Seal**  
35.VS014  
'16-23 4x

#### STREET

Please Note:  
Nikasil Piston Size  
-Std. Compression 12.8:1  
-Forged Piston  
-Fuel Injection

01.2448.A  
01.2448.B  
01.2448.C  
'19-20

96.95  
96.96  
96.97

02.2440  
02.2440  
02.2440  
'19-22

02.2440  
02.2440  
02.2440  
'19-22

02.2440  
02.2440  
02.2440  
'19-22

**Pin**  
04.1844.4  
'16-18  
**Clips**  
05.1812  
'16-23

#### ATV-UTV

CAN-AM  
GAS GAS  
HONDA  
KAWASAKI  
KTM  
POLARIS  
SUZUKI  
YAMAHA

#### PWC

KAWASAKI  
POLARIS  
SEA DOO  
YAMAHA

#### SNOW

ARCTIC CAT  
KAWASAKI  
LYNX  
MOTO-SKI  
POLARIS  
SKI DOO  
YAMAHA

#### MOPED & SCOOTER

#### MISC. TECH. SPECIAL

Footnotes: \* Bearings Only \*\* Rubbers included

**Air Filter**  
52.24014  
'16-18  
52.24018  
'19-23

**Basket**  
17.2424F \*  
'16-23  
**Clutch Rubber Set**  
17.CRS2424-8  
'16-23  
**Spring Kit**  
17.CS24036  
'16-19  
**Cover Gasket**  
19.G2440  
'16-23  
**Clutch Cable**  
53.121040  
'16-19  
53.120144  
'20  
53.121053  
'21-23

**Friction Set**  
16.S24063  
'16-19  
16.S24056  
'20-23  
**Steel Set**  
16.S24025  
'16-18  
16.S23016  
'19-23

**F/W Bearing**  
23.S114082  
'16-23  
**R/W Bearing**  
23.S112052  
'16-23  
**F/W Spacer Kit**  
26.710104  
'16-23  
**R/W Spacer Kit**  
26.710081  
'16-23  
**Steering Bearing**  
24.110001  
'16-23

**Frontbrake Disc**  
37.BD12416  
'16-23  
**Rearbrake Disc**  
37.BD22202  
'16-19  
37.BD22418  
'20  
37.BD22420  
'21-23  
**Front Pad Set**  
37.105802  
'16-20  
37.105802BX  
'16-20 Box of 10  
37.180302  
'21-23  
37.180302BX  
'21-23 Box of 10  
**Rear Pad Set**  
37.201302  
'16-23  
37.201302BX  
'16-23 Box of 10  
**Front Caliper Rebuild Kit**  
37.63011  
'16-23  
**Rear Caliper Rebuild Kit**  
37.63032  
'16-23  
**Front Master Cylinder Rebuild Kit**  
37.910010  
'16-23  
**Rear Master Cylinder Rebuild Kit**  
37.910019  
'16-23

**Front Sprocket**  
07.FS23099-13  
07.FS23099-14  
07.FS23099-15  
'16-23  
**7075-T6 Alloy Rear Sprocket**  
07.RA22099-47  
07.RA22099-48  
07.RA22099-49  
07.RA22099-50  
07.RA22099-51  
07.RA22099-52  
'16-23  
**UltraLight Steel Rear Sprocket**  
07.RS22099R-47  
07.RS22099R-48  
07.RS22099R-49  
07.RS22099R-50  
07.RS22099R-51  
07.RS22099R-52  
'16-23  
**Sprocket Bolt Set**  
07.SBSM825  
'16-23

**Chain**  
07.RC520120C  
'16-23 MX  
07.RC520120CG  
'16-23 MX Gold  
07.RC520120XC  
'16-23 X-Ring  
07.RC520120XCG  
'16-23 X-Ring Gold  
**Countershaft Seal Kit**  
26.640019  
'16-23  
**Lower Chain Roller**  
33.0007  
'16-19  
**Upper Chain Roller**  
33.0008  
'16-23

**Swingarm**  
26.210202  
'16-23  
**Linkage**  
26.110171  
'16-23  
**Upper**  
26.310016  
'16-23  
**Lower**  
26.450015  
'16-23

**Seal & Wiper**  
40.S485810  
'16-23  
**Oil Seal Set**  
40.F485810  
'16-23  
**Dust Seal Set**  
40.F4858D  
'16-23  
**Bushing Set**  
39.160126  
'16-19  
**Rear Shock Seal Head Kit**  
26.810001  
'16-20

#### DIRT

#### STREET

#### ATV-UTV

#### PWC

#### SNOW

#### MOPED & SCOOTER

#### MISC. TECH. SPECIAL





### YAMAHA

**DIRT**  
APRILIA  
BETA  
BMW  
GAS GAS  
HONDA  
HUSABERG  
HUSQVARNA  
KAWASAKI  
KTM  
MOTO TM  
RIEJU  
SHERCO  
SUZUKI  
YAMAHA

WR 450 F 4-Stroke Please Note: Nikasil Piston Size -Std. Compression 12.5:1 -Forged Piston -Fuel Injection from 2012	Piston Kit 01.2429.A 01.2429.B 01.2429.C	Size 94.95 94.96 94.97	Ring Set 02.2421 02.2421 02.2421	Crankbearing & Seal Kit 23.CBS24098* '03-23	Con. Rod Kit 03.2423 '03-06 03.2426 '07-11 03.2432 '12-15 03.2440 '16-20 03.2450 '21-23	Complete 34.2424 '03-06 34.2426 '07-15 34.2454 '16-18	Cam Chain 31.2423 '03-15 31.4409 '16-20 31.2423 '21-23	Valve 28.2423-1 '03-15 2x Exhaust Titanium 28.2423-2 '16-20 '03-15 1x Intake I Titanium 28.2423-3 '16-20 '03-15 2x Intake II Titanium 28.2444-1 '03-23 '16-20 2x Exhaust Titanium 28.2444-2 '16-18 '03-15 Titanium 28.2450-1 '19-20 '21-23 2x Exhaust Titanium 28.2450-2 '16-18 '03-15 Titanium
	01.2444.A 01.2444.B 01.2444.C	96.95 96.96 96.97	02.6427 02.6427 02.6427	Bearing 23.83CO72C '03-23 2x	Top-End 35.2423 '03-06 35.2426 '07-15 35.2424 '16-11 22.344220F '16-20 22.344220F '12-15 22.344221F '19-20 '16-23	Valve Shim Assortment 29.VSA948 '03-23 29.VSA948-2 '03-23	Head & Base 36.2403 '03-06 36.2406 '07-15 36.2414 '16-18 36.2418 '19-20 36.2450 '21-23	TI-Steel Conversion Set 28.SES2424-1 '03-15 Exhaust 28.SIS2424-2 '03-15 Intake 28.SIS2444-2 '16-18 Intake
	01.2448.A 01.2448.B 01.2448.C	96.95 96.96 96.97	02.2440 02.2440 02.2440	Pin 04.1844.4 '16-18	Crankpin 06.3460.8 '03-23	Ignition Cover Gasket 19.G92423 '03-06 19.G92406 '07-15 19.G92415 '16-18	Valve Seal 35.VS012 '03-15 3x Intake 35.VS013 '03-15 2x Exhaust 35.VS014 '16-23 4x	
	01.2450.A 01.2450.B 01.2450.C	96.95 96.96 96.97	02.2440 02.2440 02.2440	Clips 05.1814 '03-15 05.1812 '16-23				
Please Note: Nikasil Piston Size -Std. Compression 12.5:1 -Forged Piston -Fuel Injection								
Please Note: Nikasil Piston Size -Std. Compression 12.8:1 -Forged Piston -Fuel Injection								
Replating or Cylinder Sleaving Required for Oversizes								

**STREET**  
APRILIA  
CAGIVA  
HONDA  
KAWASAKI  
KTM  
SUZUKI  
YAMAHA

**ATV-UTV**  
CAN-AM  
GAS GAS  
HONDA  
KAWASAKI  
KTM  
POLARIS  
SUZUKI  
YAMAHA

**PWC**  
KAWASAKI  
POLARIS  
SEA DOO  
YAMAHA

**SNOW**  
ARCTIC CAT  
KAWASAKI  
LYNX  
MOTO-SKI  
POLARIS  
SKI DOO  
YAMAHA

**MOPED & SCOOTER**

**MISC. TECH. SPECIAL**

Footnotes: \* Bearings Only \*\* Rubbers included

**DIRT**  
APRILIA  
BETA  
BMW  
GAS GAS  
HONDA  
HUSABERG  
HUSQVARNA  
KAWASAKI  
KTM  
MOTO TM  
RIEJU  
SHERCO  
SUZUKI  
YAMAHA

Air Filter 52.23003 '03-15 52.24014 '16-18 52.24018 '19-23	Basket 17.2423 * '03 17.2424F * '04-23	Complete Plate Set 16.CPS24003 '04 16.CPS24015 '05-15	F/W Bearing 23.S116032 '03-18 23.S114082 '19-23	Frontbrake Disc 37.BD13288 '03-15 37.BD12416 '16-20	Front Sprocket 07.FS23099-13 07.FS23099-14 07.FS23099-15 '03-23	Chain 07.RC520120C '03-23 MX 07.RC520120CG '03-23 MX Gold 07.RC520120XC '03-23 X-Ring 07.RC520120XCG '03-23 X-Ring Gold	Swingarm 26.210072 '03-05 26.210158 '06-15 26.210202 '16-23	Seal & Wiper 40.S46589 '03-04 40.S485810 '05-23
	Clutch Rubber Set 17.CRS2424-8 '04-23	Friction Set 16.S24057 '03 16.S24023 '04 16.S24041 '05-15 16.S24063 '16-18 16.S24056 '19-23	R/W Bearing 23.S112052 '03-23	Rearbrake Disc 37.BD22202 '03-18 37.BD22418 '19-23	7075-T6 Alloy Rear Sprocket 07.RA22099-47 '03-04 07.RA22099-48 '03-04 07.RA22099-49 '05-18 07.RA22099-50 '03-04 07.RA22099-51 '05-18 07.RA22099-52 '03-23	Countershaft Seal Kit 26.640019 '03-23	Linkage 26.110065 '03-04 26.110128 '05 26.110142 '06 26.110145 '07-15 26.110171 '16-23	Oil Seal Set 40.F46589 '03-04 40.F485810 '05-23
	Main Jet 45.100-225 '03-11 Keihin	Spring Kit 17.CS23033 '03-15 17.CS24036 '16-18	F/W Spacer Kit 26.710073 '03-04 26.710074 '05-18 26.710104 '19-23	Front Pad Set 37.103202 '03-15 37.103202BX '03-15 Box of 10 37.105802 '16-20 37.105802BX '16-20 Box of 10 37.180302 '21-23 37.180302BX '21-23 Box of 10	UltraLight Steel Rear Sprocket 07.RS22099R-47 '03-23 07.RS22099R-48 '03-23 07.RS22099R-49 '03-23 07.RS22099R-50 '03-23 07.RS22099R-51 '03-23 07.RS22099R-52 '03-23	Lower Chain Roller 33.0007 '03-18	Upper Chain Roller 33.0008 '03-23	Dust Seal Set 40.F4658D '03-04 40.F4858D '05-23
	Pilot Jet 46.040-085 '03-11 Keihin	Cover Gasket 19.G2423 '03-15 19.G2440 '16-23	Steel Set 16.S24021 '04 16.S24025 '16-18 16.S23016 '19-23	R/W Spacer Kit 26.710081 '03-23	Rear Pad Set 37.201302 '03-23 37.201302BX '03-23 Box of 10	Upper Chain Roller 33.0008 '03-23	Sprocket Bolt Set 07.SBSM825 '03-23	Bushing Set 39.160010 '03 39.160045 '04 39.160050 '05-11 39.160075 '12-15 39.160126 '16-18
Carburetor Rebuild Kit 55.10269 '03 55.10268 '04 55.10267 '05-06 55.10266 '07-11	Clutch Cable 53.120023 '03-06 53.120022 '07-15 53.121040 '16-18 53.121052 '19-20	Steering Bearing 24.110001 '03-23	Steering Bearing 24.110001 '03-23	Rear Caliper Rebuild Kit 37.63005 '03-15 37.63011 '16-23	Lower 26.450015 '03-23	Rear Shock Seal Head Kit 26.810002 '03-20		
Throttle Cable 53.111076 '03-06 53.111072 '07-11 53.111077 '12-15 53.110250 '16-18 53.110265 '19-23	Oil Filter 54.23140 '03-23 1-Pce. 54.23140-50 '03-23 50-Pcs.	Water Pump Rebuild Kit 57.2423 '03-06 57.2426 '07-15 57.2424 '16-18		Rear Caliper Rebuild Kit 37.63032 '03-23				

**STREET**  
APRILIA  
CAGIVA  
HONDA  
KAWASAKI  
KTM  
SUZUKI  
YAMAHA

**ATV-UTV**  
CAN-AM  
GAS GAS  
HONDA  
KAWASAKI  
KTM  
POLARIS  
SUZUKI  
YAMAHA

**PWC**  
KAWASAKI  
POLARIS  
SEA DOO  
YAMAHA

**SNOW**  
ARCTIC CAT  
KAWASAKI  
LYNX  
MOTO-SKI  
POLARIS  
SKI DOO  
YAMAHA

**MOPED & SCOOTER**

**MISC. TECH. SPECIAL**





### YAMAHA

**DIRT**  
APRILIA  
BETA  
BMW  
GAS GAS  
HONDA  
HUSABERG  
HUSQVARNA  
KAWASAKI  
KTM  
MOTO TM  
RIEJU  
SHERCO  
SUZUKI  
YAMAHA

YZ 490 2-Stroke	Piston Kit -	Size 87.00	Ring Set -	Crank Bearing & Seal Kit 23.CBS23080 '82-90  Bearing 23.6306C3 '82-90 2x  Oilseal Set 42.2300 '82-90	S/E Bearing 21.3303 '82-90  B/E Bearing 22.253120 '82-90				
--------------------	-----------------	---------------	---------------	--	--	--	--	--	--

**STREET**  
APRILIA  
CAGIVA  
HONDA  
KAWASAKI  
KTM  
SUZUKI  
YAMAHA

XT 500 4-Stroke -Std. Compression 9.0:1 -Forged Piston	Piston Kit 01.2576.000 01.2576.050 01.2576.100 '76-81	Size 87.00 87.50 88.00	Ring Set - - - '76-81	Bearing 23.6306YA1C4 '76-81 Left	Con. Rod Kit 03.2576 '76-77				
---	---	---------------------------------	-----------------------------------	--	-----------------------------------	--	--	--	--

**ATV-UTV**  
CAN-AM  
GAS GAS  
HONDA  
KAWASAKI  
KTM  
POLARIS  
SUZUKI  
YAMAHA

**PWC**  
KAWASAKI  
POLARIS  
SEA DOO  
YAMAHA

XT 550 4-Stroke	Piston Kit -	Size 92.00	Ring Set -						
--------------------	-----------------	---------------	---------------	--	--	--	--	--	--

**SNOW**  
ARCTIC CAT  
KAWASAKI  
LYNX  
MOTO-SKI  
POLARIS  
SKI DOO  
YAMAHA

XT/TT 600 4-Stroke	Piston Kit 01.2601.000 01.2601.025 01.2601.050 01.2601.075 01.2601.100 01.2601.150 01.2601.200 '84-04	Size 95.00 95.25 95.50 95.75 96.00 96.50 97.00	Ring Set 02.2600.000 02.2600.025 02.2600.050 02.2600.075 02.2600.100 02.2600.150 02.2600.200 '84-04  Pin 04.2272 '84-04  Clips 05.2212 '84-04	Bearing 23.6305C3 '84-04 Left  23.6307C3 '84-04 Right	Con. Rod Kit 03.2600 '90-99 XT '94-98 TT	Top-End 35.2618 '88-04	Cam Chain 31.2661 '84-04	Valve 28.2600-1 '87-04 2x Exhaust Steel 28.2600-2 '87-04 2x Intake Steel		
-----------------------	---	---	---	--	---	------------------------------	--------------------------------	--	--	--

**MOPED & SCOOTER**

**MISC. TECH. SPECIAL**

Footnotes: \* Bearings Only \*\* Rubbers included

Carburetor Rebuild Kit 55.10527 '87-90	Clutch Cable 53.121011 '83-90	Friction Set 16.S23011 '82-90	F/W Bearing 23.S114044 '84-90  R/W Bearing 23.S112067 '82-90  Steering Bearing 24.110004 '82-90	Front Caliper Rebuild Kit 37.63015 '85-90  Front Master Cylinder Rebuild Kit 37.910017 '85-90	Front Sprocket 07.FS23080-13 07.FS23080-14 07.FS23080-15 '82-90	Chain 07.RC520120C '82-90 MX 07.RC520120CG '82-90 MX Gold 07.RC520120XC '82-90 X-Ring 07.RC520120XCG '82-90 X-Ring Gold  Lower Chain Roller 33.0008 '83-86 33.0007 '87-90  Upper Chain Roller 33.0008 '83-86 33.0007 '87-90	Swingarm 26.210143 '82 26.210026 '83-85 26.210025 '86-87 26.210075 '88-90  Linkage 26.110109 '83-85 26.110081 '86-90  Upper 26.310020 '83-90  Lower 26.450027 '83-90	Seal & Wiper 40.S435511 '82-90  Oil Seal Set 40.F435511 '82-90  Dust Seal Set 40.F4355DP '82-90  Bushing Set 39.160048 '82-90  Rear Shock Seal Head Kit 26.810116 '83
--	-------------------------------------	-------------------------------------	---	---	---	---	--	---

**DIRT**  
APRILIA  
BETA  
BMW  
GAS GAS  
HONDA  
HUSABERG  
HUSQVARNA  
KAWASAKI  
KTM  
MOTO TM  
RIEJU  
SHERCO  
SUZUKI  
YAMAHA

**STREET**  
APRILIA  
CAGIVA  
HONDA  
KAWASAKI  
KTM  
SUZUKI  
YAMAHA

**ATV-UTV**  
CAN-AM  
GAS GAS  
HONDA  
KAWASAKI  
KTM  
POLARIS  
SUZUKI  
YAMAHA

**PWC**  
KAWASAKI  
POLARIS  
SEA DOO  
YAMAHA

Oil Filter 54.27145 '76-85 1-Pce. 54.27145-50 '76-85 50-Pcs.	Spring Kit 17.CS23032 '76-81		Steering Bearing 24.110008 '76-77		Front Sprocket 07.FS23099-13 07.FS23099-14 07.FS23099-15 '77-85  7075-T6 Alloy Rear Sprocket 07.RA22080-48 07.RA22080-49 07.RA22080-50 07.RA22080-51 07.RA22080-52 '77-85  Ultralight Steel Rear Sprocket 07.RS22080R-48 07.RS22080R-49 07.RS22080R-50 07.RS22080R-51 07.RS22080R-52 '77-85  Sprocket Bolt Set 07.SBSM825 '77-85	Chain 07.RC520120C '76-85 MX 07.RC520120CG '76-85 MX Gold 07.RC520120XC '76-85 X-Ring 07.RC520120XCG '76-85 X-Ring Gold	Swingarm 26.210176 '76-81		
--	------------------------------------	--	---	--	--	---	---------------------------------	--	--

**SNOW**  
ARCTIC CAT  
KAWASAKI  
LYNX  
MOTO-SKI  
POLARIS  
SKI DOO  
YAMAHA

Oil Filter 54.27145 '82-83 1-Pce. 54.27145-50 '82-83 50-Pcs.		Friction Set 16.S26029 '82-83	R/W Bearing 23.S112048 '82-83  Steering Bearing 24.110007 '82-83		Chain 07.RC520120C '82-83 MX 07.RC520120CG '82-83 MX Gold 07.RC520120XC '82-83 X-Ring 07.RC520120XCG '82-83 X-Ring Gold	Upper Chain Roller 33.0008 '82-83			
--	--	-------------------------------------	--	--	---	---	--	--	--

Throttle Cable 53.111081 '90-95  Oil Filter 54.27145 '84-04 1-Pce. 54.27145-50 '84-04 50-Pcs.	Spring Kit 17.CS22031 '89-95 XT '83-86 TT	Friction Set 16.S26029 '84-04	F/W Bearing 23.S114044 '84-95  R/W Bearing 23.S112048 '84-95  Steering Bearing 24.110004 '84-04	Front Master Cylinder Rebuild Kit 37.910004 '90-95 XT  Rear Master Cylinder Rebuild Kit 37.910007 '90-95	Chain 07.RC520120C '84-04 MX 07.RC520120CG '84-04 MX Gold 07.RC520120XC '84-04 X-Ring 07.RC520120XCG '84-04 X-Ring Gold	Swingarm 26.210151 '84-89 XT 26.210152 '90-95 XT 26.210153 '83-86 TT  Lower Chain Roller 33.0008 '84-89 33.0001 '90-95			
---	--	-------------------------------------	---	--	---	--	--	--	--

**MOPED & SCOOTER**

**MISC. TECH. SPECIAL**



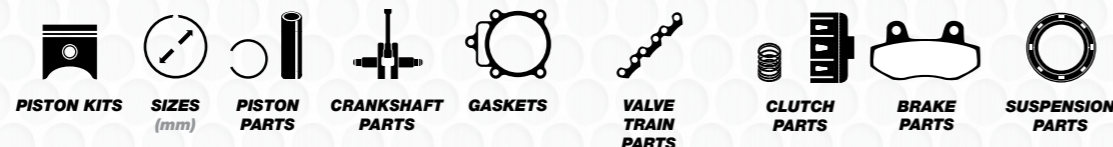

**APRILIA**

**DIRT**  
APRILIA  
BETA  
BMW  
GAS GAS  
HONDA  
HUSABERG  
HUSQVARNA  
KAWASAKI  
KTM  
MOTO TM  
RIEJU  
SHERCO  
SUZUKI  
YAMAHA

**STREET**  
APRILIA  
CAGIVA  
HONDA  
KAWASAKI  
KTM  
SUZUKI  
YAMAHA

**ATV-UTV**  
CAN-AM  
GAS GAS  
HONDA  
KAWASAKI  
KTM  
POLARIS  
SUZUKI  
YAMAHA

**PWC**  
KAWASAKI  
POLARIS  
SEA DOO  
YAMAHA

**SNOW**  
ARCTIC CAT  
KAWASAKI  
LYNX  
MOTO-SKI  
POLARIS  
SKI DOO  
YAMAHA

**MOPED & SCOOTER**

**MISC. TECH. SPECIAL**

Model	Piston kit	Size	Ring Set	Con. Rod Kit	Top-End				
<b>RS 125</b> 2-Stroke Please Note: Nikasil Piston Size	01.7203.A 01.7203.B 01.7203.C 01.7203.D 01.7203.E '92-10	53.95 53.96 53.97 53.98 53.99	02.7203 02.7203 02.7203 02.7203 02.7203 '92-10	03.7202 '92-10	35.7202 '92-10				
				<b>S/E Bearing</b> 21.3206 '92-10					
				<b>B/E Bearing</b> 22.202615 '92-10					
				<b>Oilseal Set</b> 42.7202 '92-10					
<b>RX 125</b> 2-Stroke Please Note: Nikasil Piston Size	01.7203.A 01.7203.B 01.7203.C 01.7203.D 01.7203.E '89-98	53.95 53.96 53.97 53.98 53.99	02.7203 02.7203 02.7203 02.7203 02.7203 '89-98	03.7202 '89-98	35.7202 '89-98				
				<b>S/E Bearing</b> 21.3206 '89-98					
				<b>B/E Bearing</b> 22.202615 '89-98					
				<b>Oilseal Set</b> 42.7202 '89-98					
<b>MX 125</b> 2-Stroke Please Note: Nikasil Piston Size	01.7203.A 01.7203.B 01.7203.C 01.7203.D 01.7203.E '04-06	53.95 53.96 53.97 53.98 53.99	02.7203 02.7203 02.7203 02.7203 02.7203 '04-06	03.7202 '04-06	35.7202 '04-06				
				<b>S/E Bearing</b> 21.3206 '04-06					
				<b>B/E Bearing</b> 22.202615 '04-06					
				<b>Oilseal Set</b> 42.7202 '04-06					
<b>RX/SX 125</b> 2-Stroke Please Note: Nikasil Piston Size	01.7203.A 01.7203.B 01.7203.C 01.7203.D 01.7203.E '08-10	53.95 53.96 53.97 53.98 53.99	02.7203 02.7203 02.7203 02.7203 02.7203 '08-10	03.7202 '08-10	35.7202 '08-10				
				<b>S/E Bearing</b> 21.3206 '08-10					
				<b>B/E Bearing</b> 22.202615 '08-10					
				<b>Oilseal Set</b> 42.7202 '08-10					
<b>AF1 / Sintesi / Futura</b> 2-Stroke Please Note: Nikasil Piston Size	01.7203.A 01.7203.B 01.7203.C 01.7203.D 01.7203.E '88-92	53.95 53.96 53.97 53.98 53.99	02.7203 02.7203 02.7203 02.7203 02.7203 '88-92	03.7202 '88-92	35.7202 '88-92				
				<b>S/E Bearing</b> 21.3206 '88-92					
				<b>Crankpin</b> 06.2049 '88-92					
				<b>Oilseal Set</b> 42.7202 '88-92					

**APRILIA**

Model	Piston kit	Size	Ring Set	Con. Rod Kit	Top-End				
<b>Pegaso 125 '89-94</b> <b>Red Rose 125 '87-94</b> <b>Europa 125 '90-91</b> <b>Tuono 125 '03-04</b> 2-Stroke Please Note: Nikasil Piston Size	01.7203.A 01.7203.B 01.7203.C 01.7203.D 01.7203.E	53.95 53.96 53.97 53.98 53.99	02.7203 02.7203 02.7203 02.7203 02.7203	03.7202 All	35.7202 All				
				<b>S/E Bearing</b> 21.3206 All					
				<b>B/E Bearing</b> 22.202615 All					
				<b>Oilseal Set</b> 42.7202 All					
<b>RS 250</b> 2-Stroke Please Note: Nikasil Piston Size	01.3359.A 01.3359.B 01.3359.C 01.3359.D '95-01	55.94 55.95 55.96 55.97	02.7221 02.7221 02.7221 02.7221 '95-01	03.3349 '95-01	35.7202				<b>Friction Set</b> 16.S33029 '95-01
				<b>S/E Bearing</b> 21.3349 '95-01					
				<b>B/E Bearing</b> 22.222816F '95-01					
			<b>Clips</b> 05.1610 '95-01						
				<b>Crankpin</b> 06.2247 '95-01					

**CAGIVA**

Model	Piston kit	Size	Ring Set	Con. Rod Kit					
<b>Planet / Mito 125</b> 2-Stroke Please Note: Nikasil Piston Size	01.7218.A 01.7218.B 01.7218.C 01.7219.D '90-91	55.96 55.97 55.98 55.99	02.7207 02.7207 02.7207 02.7219 '90-91						
<b>Planet 125</b> 2-Stroke Please Note: Nikasil Piston Size	-	56.00	-	03.7220 '98-03					
				<b>S/E Bearing</b> 21.2012 '98-03					
<b>Mito 125 Sport</b> 2-Stroke Please Note: Nikasil Piston Size -Forged Piston	01.7221.A 01.7221.B 01.7221.C '92-08	55.95 55.96 55.97 '92-08	02.7221 02.7221 02.7221 '92-08	03.7220 '94-08					
				<b>S/E Bearing</b> 21.2012 '94-08					
			<b>Clips</b> 05.1610 '92-08						
<b>Raptor 125</b> 2004-2007 2-Stroke Please Note: Nikasil Piston Size -Forged Piston	01.7221.A 01.7221.B 01.7221.C '04-07	55.95 55.96 55.97	02.7221 02.7221 02.7221 '04-07	03.7220 '04-07					
				<b>S/E Bearing</b> 21.2012 '04-07					
			<b>Clips</b> 05.1610 '04-07						
<b>Roadster 125</b> 2-Stroke Please Note: Nikasil Piston Size	-	56.00	-	03.7220 '95-99					
				<b>S/E Bearing</b> 21.2012 '95-99					
<b>Supercity 125</b> 2-Stroke Please Note: Nikasil Piston Size	-	56.00	-	03.7220 '97-99					
				<b>S/E Bearing</b> 21.2012 '97-99					

**DIRT**  
APRILIA  
BETA  
BMW  
GAS GAS  
HONDA  
HUSABERG  
HUSQVARNA  
KAWASAKI  
KTM  
MOTO TM  
RIEJU  
SHERCO  
SUZUKI  
YAMAHA

**STREET**  
APRILIA  
CAGIVA  
HONDA  
KAWASAKI  
KTM  
SUZUKI  
YAMAHA

**ATV-UTV**  
CAN-AM  
GAS GAS  
HONDA  
KAWASAKI  
KTM  
POLARIS  
SUZUKI  
YAMAHA

**PWC**  
KAWASAKI  
POLARIS  
SEA DOO  
YAMAHA

**SNOW**  
ARCTIC CAT  
KAWASAKI  
LYNX  
MOTO-SKI  
POLARIS  
SKI DOO  
YAMAHA

**MOPED & SCOOTER**

**MISC. TECH. SPECIAL**

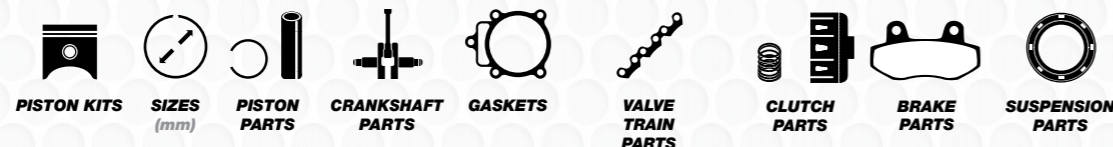

### HONDA

**DIRT**  
APRILIA  
BETA  
BMW  
GAS GAS  
HONDA  
HUSABERG  
HUSQVARNA  
KAWASAKI  
KTM  
MOTO TM  
RIEJU  
SHERCO  
SUZUKI  
YAMAHA

**STREET**  
APRILIA  
CAGIVA  
HONDA  
KAWASAKI  
KTM  
SUZUKI  
YAMAHA

**ATV-UTV**  
CAN-AM  
GAS GAS  
HONDA  
KAWASAKI  
KTM  
POLARIS  
SUZUKI  
YAMAHA

**PWC**  
KAWASAKI  
POLARIS  
SEA DOO  
YAMAHA

**SNOW**  
ARCTIC CAT  
KAWASAKI  
LYNX  
MOTO-SKI  
POLARIS  
SKI DOO  
YAMAHA

**MOPED & SCOOTER**

**MISC. TECH. SPECIAL**

Model	Piston kit	Size (mm)	Ring Set	Con. Rod Kit					
<b>SS / CS / DAX 70</b> 4-Stroke	-	47.00	-	03.1050 SS/C70					
			<b>Pin</b> 04.1338.5						
			<b>Clips</b> 05.1310						
<b>C 70</b> 4-Stroke	01.1075.000 01.1075.050 01.1075.100	47.00 47.50 48.00	- - -	03.1090					
			<b>Pin</b> 04.1338.5						
			<b>Clips</b> 05.1310						
<b>C 90</b> 4-Stroke	- 01.1090.150	47.00 48.50	- -	03.1090					
			<b>Pin</b> 04.1338.5						
			<b>Clips</b> 05.1310						
<b>MB 80</b> 2-Stroke	-	-	-	03.1103 S/E Bearing 21.1103 B/E Bearing 22.202614F Bearing 23.6204C3 Right 23.6228C3 Left					
<b>MBX 80</b> 2-Stroke	-	-	-	03.1102 S/E Bearing 21.1003 B/E Bearing 22.182414					
<b>NH 80 / LEAD 80</b> 2-Stroke	-	48.00	-	21.1003					
			<b>Clips</b> 05.1210C						
<b>NH 90</b> 2-Stroke	01.1163.000 01.1163.100 01.1163.150	48.00 49.00 49.50	- - -						
<b>C 100 Cub / Super Cub</b> 4-Stroke	01.1095.050 01.1095.100 01.1095.150 '88-96	50.50 51.00 51.50	- - -						
			<b>Pin</b> 04.1338.5						
			<b>Clips</b> 05.1310						

### HONDA

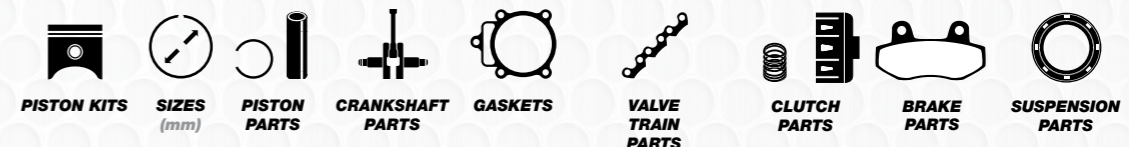

**DIRT**  
APRILIA  
BETA  
BMW  
GAS GAS  
HONDA  
HUSABERG  
HUSQVARNA  
KAWASAKI  
KTM  
MOTO TM  
RIEJU  
SHERCO  
SUZUKI  
YAMAHA

**STREET**  
APRILIA  
CAGIVA  
HONDA  
KAWASAKI  
KTM  
SUZUKI  
YAMAHA

**ATV-UTV**  
CAN-AM  
GAS GAS  
HONDA  
KAWASAKI  
KTM  
POLARIS  
SUZUKI  
YAMAHA

**PWC**  
KAWASAKI  
POLARIS  
SEA DOO  
YAMAHA

**SNOW**  
ARCTIC CAT  
KAWASAKI  
LYNX  
MOTO-SKI  
POLARIS  
SKI DOO  
YAMAHA

**MOPED & SCOOTER**

**MISC. TECH. SPECIAL**

Model	Piston kit	Size (mm)	Ring Set	Con. Rod Kit					
<b>RS 125 R</b> 2-Stroke	-	54.00	-	03.1210 '00-10 B/E Bearing 22.243117F '00-10 Washers 03W.24411.0 '00-10 2x					
<b>NES 125</b> 4-Stroke	-	-	-	03.1260					
<b>CB 125 S</b> 4-Stroke	01.1175.000 01.1175.025 01.1175.050 01.1175.075 01.1175.100	56.50 56.70 57.00 57.25 57.50	- - - -	02.1175.100					
			<b>Clips</b> 05.1510						
<b>CG 125</b> 4-Stroke	01.1176.000	56.50	-						
			<b>Clips</b> 05.1510						
<b>CG 150</b> 4-Stroke	-	-	-				Valve 28.1226-1 Exhaust Steel 28.1226-2 Intake Steel		
<b>CD 200 T</b> 4-Stroke	-	53.00	-	03.1280					
			<b>Pin</b> 04.1441	<b>Crankpin</b> 06.2643.5					
			<b>Clips</b> 05.1410C						
<b>CBF 250</b> 4-Stroke -Std. Compression 9.3:1	- '04-07	73.00	- '04-07	03.1358 '04-07			<b>Cam Chain</b> 31.1331 '04-07 <b>Valve Seal</b> 35.VS003 '04-07 2x Intake 35.VS003 '04-07 2x Exhaust <b>Valve Shim Assortment</b> 29.VSA748 '04-07 29.VSA748-2 '04-07	<b>Friction Set</b> 16.S13036 '04-07 <b>Steel Set</b> 16.S13037 '04-07	
<b>GB500</b> 4-Stroke -Flat Piston Crown -Compression 9.5:1 -Forged Piston	- 01.1589.050 01.1589.100 '87-97	92.00 92.50 93.00	- - -	03.1654 '87-97			<b>Cam Chain</b> 31.1655 '87-97 <b>Valve</b> 28.1654-1 '87-97 2x Exhaust Steel 28.1654-2 '87-97 2x Intake Steel		
			<b>Bearing</b> 23.6308C3 '87-97 Left 23.6307/18 '87-97 Right						



### HONDA

**DIRT**  
 APRILIA  
 BETA  
 BMW  
 GAS GAS  
 HONDA  
 HUSABERG  
 HUSQVARNA  
 KAWASAKI  
 KTM  
 MOTO TM  
 RIEJU  
 SHERCO  
 SUZUKI  
 YAMAHA

**STREET**  
 APRILIA  
 CAGIVA  
 HONDA  
 KAWASAKI  
 KTM  
 SUZUKI  
 YAMAHA

**ATV-UTV**  
 CAN-AM  
 GAS GAS  
 HONDA  
 KAWASAKI  
 KTM  
 POLARIS  
 SUZUKI  
 YAMAHA

**PWC**  
 KAWASAKI  
 POLARIS  
 SEA DOO  
 YAMAHA

**SNOW**  
 ARCTIC CAT  
 KAWASAKI  
 LYNX  
 MOTO-SKI  
 POLARIS  
 SKI DOO  
 YAMAHA

**MOPED & SCOOTER**

**MISC. TECH. SPECIAL**

Model	Piston kit	Size (mm)	Ring Set	Con. Rod Kit	Cam Chain	Valve	Seal & Wiper	Oil Seal Set	Dust Seal Set
<b>XBR500</b> 4-Stroke -Flat Piston Crown -Compression 9.5:1 -Forged Piston	- 01.1589.050 01.1589.100 '85-89	92.00 92.50 93.00	- - '85-89	03.1654 '85-89  <b>Bearing</b> 23.6308C3 '85-89 Left 23.6307/18 '85-89 Right	31.1683 '85-87 31.1655 '88-89  <b>Valve</b> 28.1654-1 '85-89 2x Exhaust Steel 28.1654-2 '85-89 2x Intake Steel				
<b>NX500 Dominator</b> 4-Stroke -Flat Piston Crown -Compression 9.5:1 -Forged Piston	- 01.1589.050 01.1589.100 '88-99	92.00 92.50 93.00	- - '88-99	03.1654 '88-99  <b>Bearing</b> 23.6308C3 '88-99 Left 23.6307/18 '88-99 Right	31.1683 '88-94  <b>Valve</b> 28.1654-1 '88-99 2x Exhaust Steel 28.1654-2 '88-99 2x Intake Steel				
<b>CBR 600 F</b> 4-Stroke	-	63.00	-		31.2661 '87-90		40.S435411 '87-90	40.F435411 '87-90	40.F4354DP '87-90
<b>CBR 600 F2</b> 4-Stroke	-	65.00	-		31.1691 '91-06  <b>Valve Seal</b> 35.VS008 '91-94 8x Intake 35.VS008 '91-94 8x Exhaust				
<b>CBR 600 F3</b> 4-Stroke	-	65.00	-		31.1691 '91-06  <b>Valve Seal</b> 35.VS008 '95-98 8x Intake 35.VS008 '95-98 8x Exhaust				
<b>CBR 600 F4</b> 4-Stroke	-	67.00	-				40.S435411 '99-06	40.F435411 '99-06	40.F4354DP '99-06
<b>CBR 600 RR</b> 4-Stroke	-	67.00	-		31.1691 '03-09  <b>Valve Seal</b> 35.VS008 '03-04 8x Intake 35.VS008 '03-04 8x Exhaust				

### HONDA

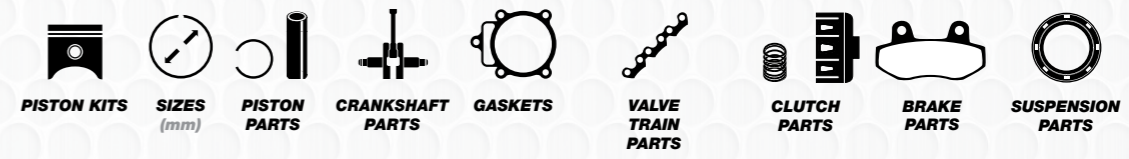

Model	Piston kit	Size (mm)	Ring Set	Cam Chain	Spring Kit	Seal & Wiper	Oil Seal Set	Dust Seal Set
<b>CBR 900 RR Fireblade</b> 4-Stroke	-	-	-	31.1993 '93-99	17.CS14007 '93-97 17.CS14009 '98-99			
<b>CBR 929 RR Fireblade</b> 4-Stroke	-	74.00	-	31.1900 '00-01	17.CS14009 '00-01	40.S43549 '00-01	40.F43549 '00-01	40.F4354DP '00-01
<b>CBR 954 RR Fireblade</b> 4-Stroke	-	75.00	-	31.1900 '02-03	17.CS14009 '02-03	40.S43549 '02-03	40.F43549 '02-03	40.F4354DP '02-03
<b>CBR 1000 F</b> 4-Stroke	-	-	-	35.VS001 '87-92 8x Intake 35.VS001 '87-92 8x Exhaust				
<b>CBR 1000 RR</b> 4-Stroke	-	75.00	-	31.1993 '04-07  <b>Valve Seal</b> 35.VS008 '04-09 8x Intake 35.VS008 '04-09 8x Exhaust		40.S435411 '04-06	40.F435411 '04-06	40.F4354DP '04-06
<b>CBR 1100 XX Blackbird</b> 4-Stroke	-	79.00	-	31.1997 '97-03		40.S43549 '96-03	40.F43549 '96-03	40.F4354DP '96-03

**DIRT**  
 APRILIA  
 BETA  
 BMW  
 GAS GAS  
 HONDA  
 HUSABERG  
 HUSQVARNA  
 KAWASAKI  
 KTM  
 MOTO TM  
 RIEJU  
 SHERCO  
 SUZUKI  
 YAMAHA

**STREET**  
 APRILIA  
 CAGIVA  
 HONDA  
 KAWASAKI  
 KTM  
 SUZUKI  
 YAMAHA

**ATV-UTV**  
 CAN-AM  
 GAS GAS  
 HONDA  
 KAWASAKI  
 KTM  
 POLARIS  
 SUZUKI  
 YAMAHA

**PWC**  
 KAWASAKI  
 POLARIS  
 SEA DOO  
 YAMAHA

**SNOW**  
 ARCTIC CAT  
 KAWASAKI  
 LYNX  
 MOTO-SKI  
 POLARIS  
 SKI DOO  
 YAMAHA

**MOPED & SCOOTER**

**MISC. TECH. SPECIAL**





### KAWASAKI

**DIRT**  
APRILIA  
BETA  
BMW  
GAS GAS  
HONDA  
HUSABERG  
HUSQVARNA  
KAWASAKI  
KTM  
MOTO TM  
RIEJU  
SHERCO  
SUZUKI  
YAMAHA

**STREET**  
APRILIA  
CAGIVA  
HONDA  
KAWASAKI  
KTM  
SUZUKI  
YAMAHA

**ATV-UTV**  
CAN-AM  
GAS GAS  
HONDA  
KAWASAKI  
KTM  
POLARIS  
SUZUKI  
YAMAHA

**PWC**  
KAWASAKI  
POLARIS  
SEA DOO  
YAMAHA

**SNOW**  
ARCTIC CAT  
KAWASAKI  
LYNX  
MOTO-SKI  
POLARIS  
SKI DOO  
YAMAHA

**MOPED & SCOOTER**

**MISC. TECH. SPECIAL**

Model	Piston kit	Size (mm)	Ring Set	S/E Bearing	B/E Bearing	Clips	Cam Chain	Friction Set	Rear Pad	Rear Shock Seal Head Kit	Front Pad	Rear Pad	Front Caliper Rebuild Kit	Rear Caliper Rebuild Kit
<b>AR 125</b> 2-Stroke	01.4020.000	55.00	02.4020.000	21.1211		05.1510								
<b>KE / KS / KD 125</b> 2-Stroke	01.4005.025	56.25	02.4005.025	21.3202		05.1410G								
<b>ER-6</b> 4-Stroke	-	83.00	-				31.4994 '06-10							
<b>ZX-6R</b> 4-Stroke	-	-	-				31.4663 '03-08							
<b>KL 650</b> 4-Stroke -Forged Piston	01.4687.000 01.4687.050 01.4687.100 '87-89	100.00 100.50 101.00	02.5594.000 02.5594.050 02.5594.100 '87-89			05.2412 '87-89		16.S46037 '87-89	37.105002 37.105002BX '87-89 Box of 10					
<b>KL 650 Tengai</b> 4-Stroke -Forged Piston	01.4687.000 01.4687.050 01.4687.100 '89-91	100.00 100.50 101.00	02.5594.000 02.5594.050 02.5594.100 '89-91			05.2412 '89-91		16.S46037 '89-91	37.105002 37.105002BX '89-91 Box of 10					
<b>KLR 650</b> 4-Stroke -Forged Piston	01.4687.000 01.4687.050 01.4687.100 '95-09	100.00 100.50 101.00	02.5594.000 02.5594.050 02.5594.100 '95-09			05.2412 '95-09		16.S47032 '95-11	37.105002 37.105002BX '95-07 Box of 10	26.810010 '92-11				
<b>KLR 650</b> 4-Stroke -Forged Piston	-	100.00	-					16.S47032 '95-11		26.810010 '92-11				
<b>KLX 650</b> 4-Stroke -Forged Piston	01.4693.A 01.4693.B 01.4693.C  01.4693.050 01.4693.100 '93-95	99.94 99.95 99.96 & 100.50 101.00	02.5594.000 02.5594.000 02.5594.000 & 02.5594.050 02.5594.100 '93-95			05.2412 '93-95		16.S46037 '93-95	37.103202 37.103202BX '93-95 Box of 10  37.201202 37.201202BX '93-95 Box of 10  37.201202BX '93-95 Box of 10	26.810007 '93-95  39.160064 '93-95				



### KAWASAKI

**DIRT**  
APRILIA  
BETA  
BMW  
GAS GAS  
HONDA  
HUSABERG  
HUSQVARNA  
KAWASAKI  
KTM  
MOTO TM  
RIEJU  
SHERCO  
SUZUKI  
YAMAHA

**STREET**  
APRILIA  
CAGIVA  
HONDA  
KAWASAKI  
KTM  
SUZUKI  
YAMAHA

**ATV-UTV**  
CAN-AM  
GAS GAS  
HONDA  
KAWASAKI  
KTM  
POLARIS  
SUZUKI  
YAMAHA

**PWC**  
KAWASAKI  
POLARIS  
SEA DOO  
YAMAHA

**SNOW**  
ARCTIC CAT  
KAWASAKI  
LYNX  
MOTO-SKI  
POLARIS  
SKI DOO  
YAMAHA

**MOPED & SCOOTER**

**MISC. TECH. SPECIAL**

Model	Piston kit	Size (mm)	Ring Set	Clips	Cam Chain	Friction Set	Front Caliper Rebuild Kit	Rear Caliper Rebuild Kit	Seal & Wiper	Oil Seal Set	Dust Seal Set	Valve Seal
<b>KLX 650 R</b> 4-Stroke Please Note: Nikasil Piston Size  Replating or Cylinder Sleeving Required for Oversizes  -Forged Piston	01.4693.A 01.4693.B 01.4693.C  01.4693.050 01.4693.100 '96-01	99.94 99.95 99.96 & 100.50 101.00	02.5594.000 02.5594.000 02.5594.000 & 02.5594.050 02.5594.100 '96-01	05.2412 '96-01		16.S46037 '96-01	37.63005 '93-96	37.63004 '96	40.S43559 '98-01	40.F43559 '98-01	40.F4355D '98-01	35.VS021 '04-10 8x Intake 35.VS021 '04-10 8x Exhaust
<b>ZX-9R</b> 4-Stroke	-	-	-		31.4994 '94-96 31.1993 '98-03							
<b>ZX-10R</b> 4-Stroke	-	76.00	-									
<b>ZX-12R</b> 4-Stroke	-	83.00	-						40.S43559 '02-05	40.F43559 '02-05	40.F4355D '02-05	
<b>ZRX-1200</b> 4-Stroke	-	70.00	-			16.S49036 '01-05			40.S43559 '01-05	40.F43559 '01-05	40.F4355D '01-05	

### KTM

### SUZUKI

**DIRT**  
APRILIA  
BETA  
BMW  
GAS GAS  
HONDA  
HUSABERG  
HUSQVARNA  
KAWASAKI  
KTM  
MOTO TM  
RIEJU  
SHERCO  
SUZUKI  
YAMAHA

**STREET**  
APRILIA  
CAGIVA  
HONDA  
KAWASAKI  
KTM  
SUZUKI  
YAMAHA

**ATV-UTV**  
CAN-AM  
GAS GAS  
HONDA  
KAWASAKI  
KTM  
POLARIS  
SUZUKI  
YAMAHA

**PWC**  
KAWASAKI  
POLARIS  
SEA DOO  
YAMAHA

**SNOW**  
ARCTIC CAT  
KAWASAKI  
LYNX  
MOTO-SKI  
POLARIS  
SKI DOO  
YAMAHA

**MOPED & SCOOTER**

**MISC. TECH. SPECIAL**

**DIRT**  
APRILIA  
BETA  
BMW  
GAS GAS  
HONDA  
HUSABERG  
HUSQVARNA  
KAWASAKI  
KTM  
MOTO TM  
RIEJU  
SHERCO  
SUZUKI  
YAMAHA

**STREET**  
APRILIA  
CAGIVA  
HONDA  
KAWASAKI  
KTM  
SUZUKI  
YAMAHA

**ATV-UTV**  
CAN-AM  
GAS GAS  
HONDA  
KAWASAKI  
KTM  
POLARIS  
SUZUKI  
YAMAHA

**PWC**  
KAWASAKI  
POLARIS  
SEA DOO  
YAMAHA

**SNOW**  
ARCTIC CAT  
KAWASAKI  
LYNX  
MOTO-SKI  
POLARIS  
SKI DOO  
YAMAHA

**MOPED & SCOOTER**

**MISC. TECH. SPECIAL**

<b>KTM 690 Duke</b> 4-Stroke Please Note: Nikasil Piston Size -Std. Compression 11.8:1 -Forged Piston	<b>Piston kit</b> 01.6608.A 01.6608.B 01.6608.C '08-11	<b>Size</b> 101.94 101.95 101.96	<b>Ring Set</b> 02.6608 02.6608 02.6608 '08-11		<b>Valve Seal</b> 35.VS026 '08-11 2x Intake 35.VS026 '08-11 2x Exhaust	<b>Rear Pad</b> 37.204202 '08-11 37.204202BX '08-11 Box of 10	<b>Seal &amp; Wiper</b> 40.S4857.89 '08-11 <b>Oil Seal Set</b> 40.F4857.89 '08-11 <b>Dust Seal Set</b> 40.F4858.8D '08-11
<b>KTM 990 Adventure</b> 4-Stroke Please Note: Nikasil Piston Size -Std. Compression 11.5:1 -Forged Piston	<b>Piston kit</b> -	<b>Size</b> 101.00	<b>Ring Set</b> -		<b>Valve Seal</b> 35.VS026 '06-12 4x Intake 35.VS026 '06-12 4x Exhaust	<b>Rear Pad</b> 37.102202 '06-12 37.102202BX '06-12 Box of 10	<b>Seal &amp; Wiper</b> 40.S4857.89 '06-12 <b>Oil Seal Set</b> 40.F4857.89 '06-12 <b>Dust Seal Set</b> 40.F4858.8D '06-12 <b>Bushing Set</b> 39.160074 '07-12
<b>KTM 990 Adventure R</b> 4-Stroke Please Note: Nikasil Piston Size -Std. Compression 11.5:1 -Forged Piston	<b>Piston kit</b> -	<b>Size</b> 101.00	<b>Ring Set</b> -		<b>Valve Seal</b> 35.VS026 '09-12 4x Intake 35.VS026 '09-12 4x Exhaust	<b>Rear Pad</b> 37.102202 '09-12 37.102202BX '09-12 Box of 10	<b>Seal &amp; Wiper</b> 40.S4857.89 '09-12 <b>Oil Seal Set</b> 40.F4857.89 '09-12 <b>Dust Seal Set</b> 40.F4858.8D '09-12
<b>KTM 990 Superduke</b> 4-Stroke Please Note: Nikasil Piston Size -Std. Compression 11.5:1 -Forged Piston	<b>Piston kit</b> -	<b>Size</b> 101.00	<b>Ring Set</b> -		<b>Valve Seal</b> 35.VS026 '05-12 4x Intake 35.VS026 '05-12 4x Exhaust	<b>Rear Pad</b> 37.204202 '05-12 37.204202BX '05-12 Box of 10	<b>Seal &amp; Wiper</b> 40.S4857.89 '05-12 <b>Oil Seal Set</b> 40.F4857.89 '05-12 <b>Dust Seal Set</b> 40.F4858.8D '05-12
<b>KTM 990 Superduke R</b> 4-Stroke Please Note: Nikasil Piston Size -Std. Compression 11.5:1 -Forged Piston	<b>Piston kit</b> -	<b>Size</b> 101.00	<b>Ring Set</b> -		<b>Valve Seal</b> 35.VS026 '07-13 4x Intake 35.VS026 '07-13 4x Exhaust	<b>Rear Pad</b> 37.204202 '07-13 37.204202BX '07-13 Box of 10	<b>Seal &amp; Wiper</b> 40.S4857.89 '07-13 <b>Oil Seal Set</b> 40.F4857.89 '07-13 <b>Dust Seal Set</b> 40.F4858.8D '07-13

<b>GP 125</b> 2-Stroke	<b>Piston kit</b> 01.3008.000 01.3008.025 - 01.3008.075 - 01.3008.125 '82-89	<b>Size</b> 56.00 56.25 56.50 56.75 57.00 57.25	<b>Ring Set</b> - 02.3008.025 - 02.3008.075 - - '82-89 <b>Clips</b> 05.1410C				
<b>RG 125 Gamma</b> 2-Stroke	<b>Piston kit</b> -	<b>Size</b> 54.00	<b>Ring Set</b> -	<b>Con. Rod Kit</b> 03.3505 <b>S/E Bearing</b> 21.3202 <b>B/E Bearing</b> 22.222816			
<b>RG 250 Gamma</b> Power Valve 2-Stroke	<b>Piston kit</b> -	<b>Size</b> 54.00	<b>Ring Set</b> -	<b>Con. Rod Kit</b> 03.3505 <b>S/E Bearing</b> 21.3202 <b>B/E Bearing</b> 22.222816			
<b>RGV 250</b> 2-Stroke Please Note: Nikasil Piston Size	<b>Piston kit</b> 01.3359.A 01.3359.B 01.3359.C 01.3359.D '89-95	<b>Size</b> 55.94 55.95 55.96 55.97	<b>Ring Set</b> 02.7207 02.7207 02.7207 02.7207 '89-95 <b>Clips</b> 05.1610 '89-95	<b>Con. Rod Kit</b> 03.3349 '89-95 <b>S/E Bearing</b> 21.3349 '89-95 <b>B/E Bearing</b> 22.222816F '89-95 <b>Crankpin</b> 06.2247 '89-95	<b>Friction Set</b> 16.S33029 '91-96		
<b>GSX-R 600</b> 4-Stroke	<b>Piston kit</b> -	<b>Size</b> -	<b>Ring Set</b> -	<b>Cam Chain</b> 31.3796 '97-00 31.3607 '01-09 <b>Valve Seal</b> 35.VS018 '97-00 8x Intake 35.VS018 '97-00 8x Exhaust 35.VS018 '04-10 8x Intake 35.VS018 '04-10 8x Exhaust	<b>Seal &amp; Wiper</b> 40.S435411 '04 <b>Oil Seal Set</b> 40.F435411 '04 <b>Dust Seal Set</b> 40.F4354DP '04		
<b>SV 650</b> 4-Stroke	<b>Piston kit</b> -	<b>Size</b> 81.00	<b>Ring Set</b> -	<b>Cam Chain</b> 31.3603 '03-09 <b>Valve Seal</b> 35.VS018 '99-10 4x Intake 35.VS018 '99-10 4x Exhaust	<b>Spring Kit</b> 17.CS44019 '03-07		



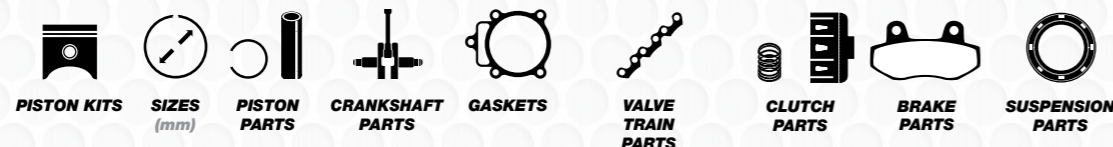

### SUZUKI

Model	Piston kit	Size (mm)	Ring Set	Cam Chain	Valve Seal	Seal & Wiper	Oil Seal Set	Dust Seal Set
<b>GSX-R 750</b> 4-Stroke	-	-	-	31.3796 '96-99 31.2661 '00-05 31.3607 '06-09	35.VS019 '85-91 8x Intake 35.VS019 '85-91 8x Exhaust 35.VS018 '92-99 8x Intake 35.VS018 '92-99 8x Exhaust 35.VS018 '04-07 8x Intake 35.VS018 '04-07 8x Exhaust	40.S435411 '96-05	40.F435411 '96-05	40.F4354DP '96-05
<b>GSX-R 1000</b> 4-Stroke	-	-	-	31.3901 '01-06	35.VS018 '05-10 8x Intake 35.VS018 '05-10 8x Exhaust	40.S43559 '05-07	40.F43559 '05-07	40.F4355D '05-07
<b>SV 1000</b> 4-Stroke	-	98.00	-	35.VS020 '03-07 4x Intake 35.VS020 '03-07 4x Exhaust	35.VS020 '03-07 4x Intake 35.VS020 '03-07 4x Exhaust			
<b>GSF 1200 Bandit</b> 4-Stroke	-	79.00	-	31.3996 '96-06	35.VS019 '96-06 8x Intake 35.VS019 '96-06 8x Exhaust	40.F435411 '97-05	40.F435411 '97-05	40.F4354DP '97-05
<b>GSX-R 1300 Hayabusa</b> 4-Stroke	-	81.00	-	31.3999 '99-09	35.VS019 '99-09 8x Intake 35.VS019 '99-09 8x Exhaust	40.S43559 '99-07	40.F43559 '99-07	40.F4355D '99-07

### YAMAHA

Model	Piston kit	Size (mm)	Ring Set	Con. Rod Kit	Pin	Clips	Crankpin	Friction Set
<b>RD 125 LC</b> 2-Stroke	01.2250.000 01.2250.050 01.2250.100	56.00 56.50 57.00	- 02.2250.050 02.2250.100	03.2250 03.2251 YPVS DT125	04.1647	05.1612C	06.2254.5	
<b>RD 125 LC - YPVS</b> 2-Stroke	-	56.00	-	03.2255				
<b>DT 125 LC</b> 2-Stroke	01.2250.000 01.2250.050 01.2250.100	56.00 56.50 57.00	- 02.2250.050 02.2250.100	03.2250 S/E Bearing 21.2250	04.1647	05.1612C	06.2254.5	
<b>DT 125 R</b> 2-Stroke	01.2245.000 01.2245.025 01.2245.050 01.2245.075 01.2245.100 01.2245.125 01.2245.150 01.2245.175 01.2245.200 '88-06	56.00 56.25 56.50 56.75 57.00 57.25 57.50 57.75 58.00	02.2245.000 02.2245.025 02.2245.050 - 02.2245.100 - 02.2245.150 - - '88-06	03.2009 '88-06	04.1647 '88-06	05.1612C '88-06	06.2256.5 '88-06	16.S22024 '05-06
<b>DT 125 X</b> 2-Stroke	01.2245.000 01.2245.025 01.2245.050 01.2245.075 01.2245.100 01.2245.125 01.2245.150 01.2245.175 01.2245.200 '05-06	56.00 56.25 56.50 56.75 57.00 57.25 57.50 57.75 58.00	02.2245.000 02.2245.025 02.2245.050 - 02.2245.100 - 02.2245.150 - - '05-06		04.1647	05.1612C		16.S22024 '05-06

**DIRT**  
APRILIA  
BETA  
BMW  
GAS GAS  
HONDA  
HUSABERG  
HUSQVARNA  
KAWASAKI  
KTM  
MOTO TM  
RIEJU  
SHERCO  
SUZUKI  
YAMAHA

**STREET**  
APRILIA  
CAGIVA  
HONDA  
KAWASAKI  
KTM  
SUZUKI  
YAMAHA

**ATV-UTV**  
CAN-AM  
GAS GAS  
HONDA  
KAWASAKI  
KTM  
POLARIS  
SUZUKI  
YAMAHA

**PWC**  
KAWASAKI  
POLARIS  
SEA DOO  
YAMAHA

**SNOW**  
ARCTIC CAT  
KAWASAKI  
LYNX  
MOTO-SKI  
POLARIS  
SKI DOO  
YAMAHA

**MOPED & SCOOTER**

**MISC. TECH. SPECIAL**

**DIRT**  
APRILIA  
BETA  
BMW  
GAS GAS  
HONDA  
HUSABERG  
HUSQVARNA  
KAWASAKI  
KTM  
MOTO TM  
RIEJU  
SHERCO  
SUZUKI  
YAMAHA

**STREET**  
APRILIA  
CAGIVA  
HONDA  
KAWASAKI  
KTM  
SUZUKI  
YAMAHA

**ATV-UTV**  
CAN-AM  
GAS GAS  
HONDA  
KAWASAKI  
KTM  
POLARIS  
SUZUKI  
YAMAHA

**PWC**  
KAWASAKI  
POLARIS  
SEA DOO  
YAMAHA

**SNOW**  
ARCTIC CAT  
KAWASAKI  
LYNX  
MOTO-SKI  
POLARIS  
SKI DOO  
YAMAHA

**MOPED & SCOOTER**

**MISC. TECH. SPECIAL**

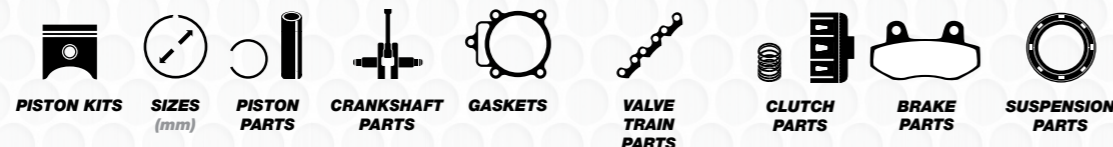

**YAMAHA**

**DIRT**  
APRILIA  
BETA  
BMW  
GAS GAS  
HONDA  
HUSABERG  
HUSQVARNA  
KAWASAKI  
KTM  
MOTO TM  
RIEJU  
SHERCO  
SUZUKI  
YAMAHA

**STREET**  
APRILIA  
CAGIVA  
HONDA  
KAWASAKI  
KTM  
SUZUKI  
YAMAHA

**ATV-UTV**  
CAN-AM  
GAS GAS  
HONDA  
KAWASAKI  
KTM  
POLARIS  
SUZUKI  
YAMAHA

**PWC**  
KAWASAKI  
POLARIS  
SEA DOO  
YAMAHA

**SNOW**  
ARCTIC CAT  
KAWASAKI  
LYNX  
MOTO-SKI  
POLARIS  
SKI DOO  
YAMAHA

**MOPED & SCOOTER**

**MISC. TECH. SPECIAL**

Model	Piston kit	Size (mm)	Ring Set	Con. Rod Kit					
<b>TZR 125/250</b> 2-Stroke	01.2247.000	56.40	-	03.2009 TZR 125					
			<b>Pin</b> 04.1647	03.2010 '86-90 no b/e pin TZR 250					
			<b>Clips</b> 05.1612C	<b>S/E Bearing</b> 21.2011					
				<b>B/E Bearing</b> 22.222917					
				<b>Crankpin</b> 06.2256.5 TZR 125					
				<b>Oilseal Set</b> 42.2280					
<b>TZR/TDR 125/250</b> 2-Stroke Please Note: Nikasil Piston Size	-	56.00	-	03.2009					
				<b>S/E Bearing</b> 21.2011 '95-97					
				<b>B/E Bearing</b> 22.222917					
				<b>Crankpin</b> 06.2256.5					
<b>IT 175</b> 2-Stroke	-	66.00	-	03.2250					
			<b>Pin</b> 04.1657	<b>S/E Bearing</b> 21.2250					
			<b>Clips</b> 05.1612C	<b>B/E Bearing</b> 22.222816					
				<b>Crankpin</b> 06.2254.5					
<b>DT 175</b> 2-Stroke	01.2272.125	67.25	02.2272.125	03.2301					
			<b>Pin</b> 04.1657	<b>S/E Bearing</b> 21.2012					
			<b>Clips</b> 05.1612G	<b>B/E Bearing</b> 22.222816					
				<b>Crankpin</b> 06.2254.5					
<b>DT 175 K</b> 2-Stroke	-	-	-	03.2303					
				<b>S/E Bearing</b> 21.2012					
				<b>B/E Bearing</b> 22.222816					
				<b>Crankpin</b> 06.2254.5					
<b>DT 175-195</b> 2-Stroke	-	66.00	-	03.2301					
				<b>S/E Bearing</b> 21.2012					
				<b>B/E Bearing</b> 22.222816					
				<b>Crankpin</b> 06.2254.5					

**YAMAHA**

Model	Piston kit	Size (mm)	Ring Set	Con. Rod Kit					
<b>DT 200 R</b> 2-Stroke	01.2281.000 01.2281.025 01.2281.050 01.2281.075 01.2281.100 01.2281.125 01.2281.150 01.2281.175 01.2281.200	66.00 66.25 66.50 66.75 67.00 67.25 67.50 67.75 68.00	- 02.2281.025 02.2281.050 -	03.2310F <b>S/E Bearing</b> 21.2020 <b>B/E Bearing</b> 22.222917F <b>Crankpin</b> 06.2256.5					
				<b>Pin</b> 04.1654					
				<b>Oilseal Set</b> 42.2280					
				<b>Clips</b> 05.1612C					
<b>IT 200</b> 2-Stroke	-	-	-	03.2310F					
				<b>S/E Bearing</b> 21.2020					
				<b>B/E Bearing</b> 22.222917F					
				<b>Crankpin</b> 06.2256.5					
<b>RD 250 Air Cooled</b> 2-Stroke	-	-	-	03.2025 '73-75				<b>Friction Set</b> 16.S23026 '73-75	
				<b>S/E Bearing</b> 21.2012 '73-75					
				<b>B/E Bearing</b> 22.222816 '73-75					
<b>RD 250 LC</b> 2-Stroke	01.2021.000 01.2021.025 01.2021.050 01.2021.075 01.2021.100 01.2021.125 01.2021.150 '80-83	54.00 54.25 54.50 54.75 55.00 55.25 55.50	- - - 02.2021.075 -	03.2020 '80-83				<b>Friction Set</b> 16.S23026 '73-75	
				<b>S/E Bearing</b> 21.2011 '80-83				<b>Steel Set</b> 16.S23027 '73-75	
				<b>B/E Bearing</b> 22.222916 '80-83					
				<b>Clips</b> 05.1612C '80-83					
				<b>Oilseal Set</b> 42.2020 '80-83					
<b>YP 250 Majesty</b> 4-Stroke	-	69.00	-					<b>Valve</b> 28.2396-1 '98-00 2x Exhaust Steel 28.2396-2 '98-00 2x Intake Steel	
								<b>Valve Seal</b> 35.VS015 '98-03 1x Intake 35.VS015 '98-03 1x Exhaust	
<b>XG 250 Tricker</b> 4-Stroke	-	74.00	-					<b>Friction Set</b> 16.S23047 '05-06	<b>Rear Pad</b> 37.201202 '05-06 37.201202BX '05-06 Box of 10

**DIRT**  
APRILIA  
BETA  
BMW  
GAS GAS  
HONDA  
HUSABERG  
HUSQVARNA  
KAWASAKI  
KTM  
MOTO TM  
RIEJU  
SHERCO  
SUZUKI  
YAMAHA

**STREET**  
APRILIA  
CAGIVA  
HONDA  
KAWASAKI  
KTM  
SUZUKI  
YAMAHA

**ATV-UTV**  
CAN-AM  
GAS GAS  
HONDA  
KAWASAKI  
KTM  
POLARIS  
SUZUKI  
YAMAHA

**PWC**  
KAWASAKI  
POLARIS  
SEA DOO  
YAMAHA

**SNOW**  
ARCTIC CAT  
KAWASAKI  
LYNX  
MOTO-SKI  
POLARIS  
SKI DOO  
YAMAHA

**MOPED & SCOOTER**

**MISC. TECH. SPECIAL**

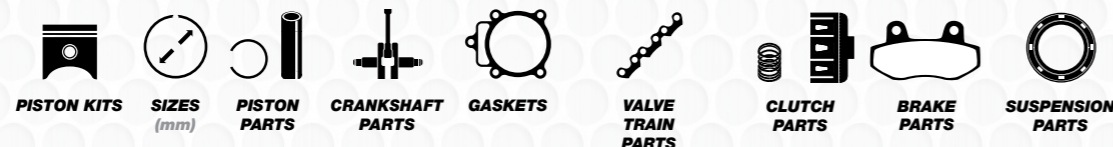

**YAMAHA**

**DIRT**  
APRILIA  
BETA  
BMW  
GAS GAS  
HONDA  
HUSABERG  
HUSQVARNA  
KAWASAKI  
KTM  
MOTO TM  
RIEJU  
SHERCO  
SUZUKI  
YAMAHA

<b>WR 250 R</b> 4-Stroke -Std. Compression 11.8:1 -Fuel Injection -Forged Piston	<b>Piston kit</b> - '08-20	<b>Size</b> 77.00	<b>Ring Set</b> - '08-20	<b>Bearing</b> 23.830046-1 '09-20 1x Right  <b>Oil Filter</b> 54.23140 '08-20 1-Pce. 54.23140-50 '08-20 50-Pcs.	<b>Top-End</b> 35.2408 '08-20	<b>Cam Chain</b> 31.2423 '08-20  <b>Valve Shim Assortment</b> 29.VSA748 '08-20 29.VSA748-2 '08-20  <b>Valve Seal</b> 35.VS027 '08-20 4x	<b>Complete Plate Set</b> 16.CPS23007 '08-20  <b>Friction Set</b> 16.S22004 '08-20  <b>Steel Set</b> 16.S22005 '08-20  <b>Spring Kit</b> 17.CS22031 '08-20	<b>Front Pad</b> 37.103202 '08-20 37.103202BX '08-20 Box of 10  <b>Rear Pad</b> 37.201302 '08-20 37.201302BX '08-20 Box of 10	<b>Seal &amp; Wiper</b> 40.S46589 '08-20  <b>Oil Seal Set</b> 40.F46589 '08-20  <b>Dust Seal Set</b> 40.F4658D '08-20  <b>Bushing Set</b> 39.160010 '08-20
--	----------------------------------	----------------------	--------------------------------	---	-------------------------------------	---	--	---	--

**STREET**  
APRILIA  
CAGIVA  
HONDA  
KAWASAKI  
KTM  
SUZUKI  
YAMAHA

<b>WR 250 X</b> 4-Stroke -Std. Compression 11.8:1 -Fuel Injection -Forged Piston	<b>Piston kit</b> - '08-11	<b>Size</b> 77.00	<b>Ring Set</b> - '08-11	<b>Bearing</b> 23.830046-1 '08 2x  23.830046-1 '09-11 1x Right  <b>Oil Filter</b> 54.23140 '08-11 1-Pce. 54.23140-50 '08-11 50-Pcs.	<b>Top-End</b> 35.2408 '08-11	<b>Cam Chain</b> 31.2423 '08-11  <b>Valve Shim Assortment</b> 29.VSA748 '08-11 29.VSA748-2 '08-11  <b>Valve Seal</b> 35.VS027 '08-11 4x	<b>Complete Plate Set</b> 16.CPS23007 '08-11  <b>Friction Set</b> 16.S22004 '08-11  <b>Steel Set</b> 16.S22005 '08-11  <b>Spring Kit</b> 17.CS22031 '08-11	<b>Rear Pad</b> 37.201302 '08-11 37.201302BX '08-11 Box of 10	<b>Seal &amp; Wiper</b> 40.S46589 '08-11  <b>Oil Seal Set</b> 40.F46589 '08-11  <b>Dust Seal Set</b> 40.F4658D '08-11  <b>Bushing Set</b> 39.160010 '08-11
--	----------------------------------	----------------------	--------------------------------	--	-------------------------------------	---	--	--	--

**ATV-UTV**  
CAN-AM  
GAS GAS  
HONDA  
KAWASAKI  
KTM  
POLARIS  
SUZUKI  
YAMAHA

<b>RD 350 Air Cooled</b> 2-Stroke	<b>Piston kit</b> 01.2020.000 01.2020.025 01.2020.050 01.2020.075 01.2020.100 01.2020.125 01.2020.150 01.2020.175 01.2020.200 01.2020.250 '73-75	<b>Size</b> 64.00 64.25 64.50 64.75 65.00 65.25 65.50 65.75 66.00 66.50	<b>Ring Set</b> 02.2020.000 02.2020.025 02.2020.050 02.2020.075 02.2020.100 02.2020.125 02.2020.150 02.2020.175 02.2020.200 02.2020.250 '73-75  <b>Pin</b> 04.1654 '73-75  <b>Clips</b> 05.1612C '73-75	<b>Con. Rod Kit</b> 03.2025 '73-75  <b>S/E Bearing</b> 21.2012 '73-75  <b>B/E Bearing</b> 22.222816 '73-75		<b>Friction Set</b> 16.S23026 '73-75			
--------------------------------------	---	---	--	--	--	--	--	--	--

**PWC**  
KAWASAKI  
POLARIS  
SEA DOO  
YAMAHA

<b>RD 350 LC</b> 2-Stroke	<b>Piston kit</b> 01.2020.000 01.2020.025 01.2020.050 01.2020.075 01.2020.100 01.2020.125 01.2020.150 01.2020.175 01.2020.200 01.2020.250 '80-82	<b>Size</b> 64.00 64.25 64.50 64.75 65.00 65.25 65.50 65.75 66.00 66.50	<b>Ring Set</b> 02.2020.000 02.2020.025 02.2020.050 02.2020.075 02.2020.100 02.2020.125 02.2020.150 02.2020.175 02.2020.200 02.2020.250 '80-82  <b>Pin</b> 04.1654 '80-92  <b>Clips</b> 05.1612C '80-92	<b>Con. Rod Kit</b> 03.2020 '80-82  <b>S/E Bearing</b> 21.2020 '80-92  <b>B/E Bearing</b> 22.222916 '80-82  <b>Oilseal Set</b> 42.2020 '80-92		<b>Friction Set</b> 16.S23026 '80-92  <b>Steel Set</b> 16.S23027 '80-92  <b>Spring Kit</b> 17.CS24037 '80-92			
------------------------------	---	---	--	---	--	--	--	--	--

**SNOW**  
ARCTIC CAT  
KAWASAKI  
LYNX  
MOTO-SKI  
POLARIS  
SKI DOO  
YAMAHA

<b>SRX 600</b> ALL YEARS 4-Stroke	<b>Piston kit</b> 01.2601.100 01.2601.150 01.2601.200	<b>Size</b> 96.00 96.50 97.00	<b>Ring Set</b> 02.2600.100 02.2600.150 02.2600.200  <b>Pin</b> 04.2272  <b>Clips</b> 05.2212	<b>Bearing</b> 23.6307C3 '84-96	<b>Cam Chain</b> 31.2661	<b>Friction Set</b> 16.S26029	<b>Seal &amp; Wiper</b> 40.S36488 '84-96  <b>Oil Seal Set</b> 40.F36488 '84-96  <b>Dust Seal Set</b> 40.F3648D '84-96		
---	--	--	--	---------------------------------------	-----------------------------	----------------------------------	---	--	--

**MOPED & SCOOTER**

**MISC. TECH. SPECIAL**



**YAMAHA**

**DIRT**  
APRILIA  
BETA  
BMW  
GAS GAS  
HONDA  
HUSABERG  
HUSQVARNA  
KAWASAKI  
KTM  
MOTO TM  
RIEJU  
SHERCO  
SUZUKI  
YAMAHA

<b>RD 350 LC - YPVS</b> 2-Stroke	<b>Piston kit</b> 01.2020.000 01.2020.025 01.2020.050 01.2020.075 01.2020.100 01.2020.125 01.2020.150 01.2020.175 01.2020.200 01.2020.250 '83-92	<b>Size</b> 64.00 64.25 64.50 64.75 65.00 65.25 65.50 65.75 66.00 66.50	<b>Ring Set</b> 02.2020.000 02.2020.025 02.2020.050 02.2020.075 02.2020.100 02.2020.125 02.2020.150 02.2020.175 02.2020.200 02.2020.250 '83-92  <b>Pin</b> 04.1654 '80-92  <b>Clips</b> 05.1612C '80-92  <b>Bearing</b> 23.83464A '86-92 Left, Center 1+2 23.83406 '86-92 Right  <b>Oilseal Set</b> 42.2020 '80-92	<b>Con. Rod Kit</b> 03.2021 or 03.2021F High Performance '83-92  <b>S/E Bearing</b> 21.2020 '80-92  <b>B/E Bearing</b> 22.222917 or 22.222917F High Performance '83-92  <b>Basket</b> 17.2020  <b>Friction Set</b> 16.S23026 '80-92  <b>Steel Set</b> 16.S23027 '80-92  <b>Spring Kit</b> 17.CS24037 '80-92					
-------------------------------------	---	---	--	--	--	--	--	--	--

**STREET**  
APRILIA  
CAGIVA  
HONDA  
KAWASAKI  
KTM  
SUZUKI  
YAMAHA

<b>RD 400</b> 2-Stroke	<b>Piston kit</b> 01.2020.000 01.2020.025 01.2020.050 01.2020.075 01.2020.100 01.2020.125 01.2020.150 01.2020.175 01.2020.200 01.2020.250 '76-79	<b>Size</b> 64.00 64.25 64.50 64.75 65.00 65.25 65.50 65.75 66.00 66.50	<b>Ring Set</b> 02.2020.000 02.2020.025 02.2020.050 02.2020.075 02.2020.100 02.2020.125 02.2020.150 02.2020.175 02.2020.200 02.2020.250 '76-79  <b>Pin</b> 04.1654 '76-79  <b>Clips</b> 05.1612C '76-79  <b>Bearing</b> 23.83406 '76-79 Right + Left Center 1+2	<b>Con. Rod Kit</b> 03.2070 '76-79  <b>S/E Bearing</b> 21.2012 '76-79  <b>B/E Bearing</b> 22.222816 '76-79  <b>Crankpin</b> 06.2251 '76-79  <b>Bearing</b> 23.83406 '76-79 Right + Left Center 1+2	<b>Friction Set</b> 16.S23026 '76-79  <b>Steel Set</b> 16.S23027 '76-79  <b>Spring Kit</b> 17.CS24037 '76-79				
---------------------------	---	---	--	--	--	--	--	--	--

**ATV-UTV**  
CAN-AM  
GAS GAS  
HONDA  
KAWASAKI  
KTM  
POLARIS  
SUZUKI  
YAMAHA

<b>XTZ 600</b> 4-Stroke	<b>Piston kit</b> 01.2601.000 01.2601.025 01.2601.050 01.2601.075 01.2601.100 01.2601.150 01.2601.200 '83-90	<b>Size</b> 95.00 95.25 95.50 95.75 96.00 96.50 97.00	<b>Ring Set</b> 02.2600.000 02.2600.025 02.2600.050 02.2600.075 02.2600.100 02.2600.150 02.2600.200 '83-90  <b>Pin</b> 04.2272 '83-90  <b>Clips</b> 05.2212 '83-90	<b>Cam Chain</b> 31.2661 '83-90  <b>Valve</b> 28.2600-1 '86-90 2x Exhaust Steel 28.2600-2 '86-90 2x Intake Steel	<b>Friction Set</b> 16.S26029 '83-90				
----------------------------	--	--	--	--	--	--	--	--	--

**PWC**  
KAWASAKI  
POLARIS  
SEA DOO  
YAMAHA

<b>SRX 600</b> ALL YEARS 4-Stroke	<b>Piston kit</b> 01.2601.100 01.2601.150 01.2601.200	<b>Size</b> 96.00 96.50 97.00	<b>Ring Set</b> 02.2600.100 02.2600.150 02.2600.200  <b>Pin</b> 04.2272  <b>Clips</b> 05.2212	<b>Bearing</b> 23.6307C3 '84-96	<b>Cam Chain</b> 31.2661	<b>Friction Set</b> 16.S26029	<b>Seal &amp; Wiper</b> 40.S36488 '84-96  <b>Oil Seal Set</b> 40.F36488 '84-96  <b>Dust Seal Set</b> 40.F3648D '84-96		
---	--	--	--	---------------------------------------	-----------------------------	----------------------------------	---	--	--

**SNOW**  
ARCTIC CAT  
KAWASAKI  
LYNX  
MOTO-SKI  
POLARIS  
SKI DOO  
YAMAHA

**MOPED & SCOOTER**

**MISC. TECH. SPECIAL**

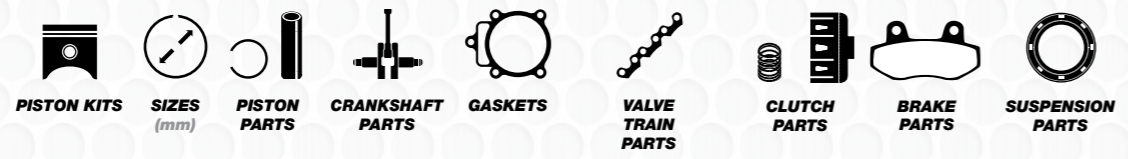

### YAMAHA

**DIRT**  
APRILIA  
BETA  
BMW  
GAS GAS  
HONDA  
HUSABERG  
HUSQVARNA  
KAWASAKI  
KTM  
MOTO TM  
RIEJU  
SHERCO  
SUZUKI  
YAMAHA

**STREET**  
APRILIA  
CAGIVA  
HONDA  
KAWASAKI  
KTM  
SUZUKI  
YAMAHA

**ATV-UTV**  
CAN-AM  
GAS GAS  
HONDA  
KAWASAKI  
KTM  
POLARIS  
SUZUKI  
YAMAHA

**PWC**  
KAWASAKI  
POLARIS  
SEA DOO  
YAMAHA

**SNOW**  
ARCTIC CAT  
KAWASAKI  
LYNX  
MOTO-SKI  
POLARIS  
SKI DOO  
YAMAHA

**MOPED & SCOOTER**

**MISC. TECH. SPECIAL**

<b>FZ 6 Fazer</b> 4-Stroke	<b>Piston kit</b> -	<b>Size</b> 65.50	<b>Ring Set</b> -		<b>Cam Chain</b> 31.2669 '04-09	<b>Friction Set</b> 16.S26034 '04-06		<b>Seal &amp; Wiper</b> 40.S435511 '04-08  <b>Oil Seal Set</b> 40.F435511 '04-08  <b>Dust Seal Set</b> 40.F4355D '04-08
<b>R6</b> 4-Stroke	<b>Piston kit</b> -	<b>Size</b> -	<b>Ring Set</b> -		<b>Cam Chain</b> 31.2669 '99-05	<b>Spring Kit</b> 17.CS24036 '99-02 '06-07		<b>Seal &amp; Wiper</b> 40.S435511 '99-04  <b>Oil Seal Set</b> 40.F435511 '99-04  <b>Dust Seal Set</b> 40.F4355D '99-04
<b>XTZ 660</b> 4-Stroke	<b>Piston kit</b> 01.2660.000 01.2660.050 01.2660.100 '91-96	<b>Size</b> 100.00 100.50 101.00	<b>Ring Set</b> 02.2660.000 02.2660.050 02.2660.100 '91-96  <b>Pin</b> 04.2270 '91-96  <b>Clips</b> 05.2214 '91-96	<b>Bearing</b> 23.6307 '91-96 Right  <b>Oil Filter</b> 54.27145 '91-99 1-Pce. 54.27145-50 '91-99 50-Pcs.	<b>Cam Chain</b> 31.2661 '91-96  <b>Valve</b> 28.2661-1 '91-96 2x Exhaust Steel 28.2661-2 '91-96 2x Intake Steel	<b>Friction Set</b> 16.S26029 '91-96		
<b>SZR660</b> 4-Stroke	<b>Piston kit</b> 01.2660.000 01.2660.050 01.2660.100 '95-97	<b>Size</b> 100.00 100.50 101.00	<b>Ring Set</b> 02.2660.000 02.2660.050 02.2660.100 '95-97  <b>Pin</b> 04.2270 '95-97  <b>Clips</b> 05.2214 '95-97	<b>Bearing</b> 23.6307 '95-97 Right  <b>Oil Filter</b> 54.27145 '95-97 1-Pce. 54.27145-50 '95-97 50-Pcs.	<b>Cam Chain</b> 31.2661 '95-97  <b>Valve</b> 28.2661-1 '95-97 Exhaust Steel 28.2661-2 '95-97 Intake Steel	<b>Friction Set</b> 16.S26029 '95-97		
<b>MT-03</b> 4-Stroke Please Note: Nikasil Piston Size -Std. Compression 10:1 -Forged Piston	<b>Piston kit</b> 01.2664.A 01.2664.B 01.2664.C '06-11	<b>Size</b> 99.95 99.96 99.97	<b>Ring Set</b> 02.5594.000 02.5594.000 02.5594.000 '06-11  <b>Pin</b> 04.2363.5 '06-11  <b>Clips</b> 05.2318 '06-11	<b>Oil Filter</b> 54.27145 '06-11 1-Pce. 54.27145-50 '06-11 50-Pcs.	<b>Cam Chain</b> 31.2706 '06-11  <b>Valve</b> 28.2706-1 '06-11 Exhaust Steel 28.2706-2 '06-11 Intake Steel  <b>Valve Seal</b> 35.VS015 '06-11 2x Intake 35.VS015 '06-11 2x Exhaust	<b>Friction Set</b> 16.S26054 '06-11	<b>Rear Pad</b> 37.204202 '06-11 Box of 10	

### YAMAHA

<b>XT 660 X</b> 4-Stroke Please Note: Nikasil Piston Size -Std. Compression 10:1 -Forged Piston	<b>Piston kit</b> 01.2664.A 01.2664.B 01.2664.C '04-11	<b>Size</b> 99.95 99.96 99.97	<b>Ring Set</b> 02.5594.000 02.5594.000 02.5594.000 '04-11  <b>Pin</b> 04.2363.5 '04-11  <b>Clips</b> 05.2318 '04-11	<b>Oil Filter</b> 54.27145 '04-11 1-Pce. 54.27145-50 '04-11 50-Pcs.	<b>Cam Chain</b> 31.2706 '04-11  <b>Valve</b> 28.2706-1 '04-11 Exhaust Steel 28.2706-2 '04-11 Intake Steel  <b>Valve Seal</b> 35.VS015 '04-11 2x Intake 35.VS015 '04-11 2x Exhaust	<b>Friction Set</b> 16.S26054 '04-11	<b>Rear Pad</b> 37.204202 '04-11 Box of 10	
<b>XT 660 R</b> 4-Stroke Please Note: Nikasil Piston Size -Std. Compression 10:1 -Forged Piston	<b>Piston kit</b> 01.2664.A 01.2664.B 01.2664.C '04-11	<b>Size</b> 99.95 99.96 99.97	<b>Ring Set</b> 02.5594.000 02.5594.000 02.5594.000 '04-11  <b>Pin</b> 04.2363.5 '04-11  <b>Clips</b> 05.2318 '04-11	<b>Oil Filter</b> 54.27145 '04-11 1-Pce. 54.27145-50 '04-11 50-Pcs.	<b>Cam Chain</b> 31.2706 '04-11  <b>Valve</b> 28.2706-1 '04-11 Exhaust Steel 28.2706-2 '04-11 Intake Steel  <b>Valve Seal</b> 35.VS015 '04-11 2x Intake 35.VS015 '04-11 2x Exhaust	<b>Friction Set</b> 16.S26054 '04-11	<b>Rear Pad</b> 37.204202 '04-11 Box of 10	
<b>XT660Z Tenere</b> 4-Stroke Please Note: Nikasil Piston Size -Std. Compression 10:1 -Forged Piston	<b>Piston kit</b> 01.2664.A 01.2664.B 01.2664.C '08-13	<b>Size</b> 99.95 99.96 99.97	<b>Ring Set</b> 02.5594.000 02.5594.000 02.5594.000 '08-13  <b>Pin</b> 04.2363.5 '08-13  <b>Clips</b> 05.2318 '08-13		<b>Cam Chain</b> 31.2706 '08-13  <b>Valve</b> 28.2706-1 '08-13 Exhaust Steel 28.2706-2 '08-13 Intake Steel  <b>Valve Seal</b> 35.VS015 '08-13 2x Intake 35.VS015 '08-13 2x Exhaust	<b>Friction Set</b> 16.S26054 '08-13	<b>Rear Pad</b> 37.204202 '08-13 Box of 10	
<b>TDM 850</b> 4-Stroke	<b>Piston kit</b> -	<b>Size</b> 89.50	<b>Ring Set</b> -	<b>Oil Filter</b> 54.27145 '91-01 1-Pce. 54.27145-50 '91-01 50-Pcs.	<b>Cam Chain</b> 31.2891 '91-01		<b>Seal &amp; Wiper</b> 40.S435511 '91-97  <b>Oil Seal Set</b> 40.F435511 '91-97  <b>Dust Seal Set</b> 40.F4355D '91-97	
<b>TRX 850</b> 4-Stroke	<b>Piston kit</b> -	<b>Size</b> 89.50	<b>Ring Set</b> -	<b>Oil Filter</b> 54.27145 '95-00 1-Pce. 54.27145-50 '95-00 50-Pcs.	<b>Cam Chain</b> 31.2891 '96-97			

**DIRT**  
APRILIA  
BETA  
BMW  
GAS GAS  
HONDA  
HUSABERG  
HUSQVARNA  
KAWASAKI  
KTM  
MOTO TM  
RIEJU  
SHERCO  
SUZUKI  
YAMAHA

**STREET**  
APRILIA  
CAGIVA  
HONDA  
KAWASAKI  
KTM  
SUZUKI  
YAMAHA

**ATV-UTV**  
CAN-AM  
GAS GAS  
HONDA  
KAWASAKI  
KTM  
POLARIS  
SUZUKI  
YAMAHA

**PWC**  
KAWASAKI  
POLARIS  
SEA DOO  
YAMAHA

**SNOW**  
ARCTIC CAT  
KAWASAKI  
LYNX  
MOTO-SKI  
POLARIS  
SKI DOO  
YAMAHA

**MOPED & SCOOTER**

**MISC. TECH. SPECIAL**

**YAMAHA**

**DIRT**  
 APRILIA  
 BETA  
 BMW  
 GAS GAS  
 HONDA  
 HUSABERG  
 HUSQVARNA  
 KAWASAKI  
 KTM  
 MOTO TM  
 RIEJU  
 SHERCO  
 SUZUKI  
 YAMAHA

**STREET**  
 APRILIA  
 CAGIVA  
 HONDA  
 KAWASAKI  
 KTM  
 SUZUKI  
 YAMAHA

**ATV-UTV**  
 CAN-AM  
 GAS GAS  
 HONDA  
 KAWASAKI  
 KTM  
 POLARIS  
 SUZUKI  
 YAMAHA

**PWC**  
 KAWASAKI  
 POLARIS  
 SEA DOO  
 YAMAHA

**SNOW**  
 ARCTIC CAT  
 KAWASAKI  
 LYNX  
 MOTO-SKI  
 POLARIS  
 SKI DOO  
 YAMAHA

**MOPED & SCOOTER**

**MISC. TECH. SPECIAL**

Model	Piston kit	Size (mm)	Ring Set	Cam Chain	Seal & Wiper
FZ 1 Fazer 4-Stroke	-	-	-	31.1997 '01-05 31.2904 '06-08	40.S435511 '01-05 40.S43559 '06-07  Oil Seal Set 40.F435511 '01-05 40.F43559 '06-07  Dust Seal Set 40.F4355D '01-07
R1 4-Stroke	-	74.00	-	31.1997 '99-03 31.2904 '04-06	40.S43559 '02-10  Oil Seal Set 40.F43559 '02-10  Dust Seal Set 40.F4355D '02-10

**DIRT**  
 APRILIA  
 BETA  
 BMW  
 GAS GAS  
 HONDA  
 HUSABERG  
 HUSQVARNA  
 KAWASAKI  
 KTM  
 MOTO TM  
 RIEJU  
 SHERCO  
 SUZUKI  
 YAMAHA

**STREET**  
 APRILIA  
 CAGIVA  
 HONDA  
 KAWASAKI  
 KTM  
 SUZUKI  
 YAMAHA

**ATV-UTV**  
 CAN-AM  
 GAS GAS  
 HONDA  
 KAWASAKI  
 KTM  
 POLARIS  
 SUZUKI  
 YAMAHA

**PWC**  
 KAWASAKI  
 POLARIS  
 SEA DOO  
 YAMAHA

**SNOW**  
 ARCTIC CAT  
 KAWASAKI  
 LYNX  
 MOTO-SKI  
 POLARIS  
 SKI DOO  
 YAMAHA

**MOPED & SCOOTER**

**MISC. TECH. SPECIAL**



**DIRT**  
APRILIA  
BETA  
BMW  
GAS GAS  
HONDA  
HUSABERG  
HUSQVARNA  
KAWASAKI  
KTM  
MOTO TM  
RIEJU  
SHERCO  
SUZUKI  
YAMAHA

**STREET**  
APRILIA  
CAGIVA  
HONDA  
KAWASAKI  
KTM  
SUZUKI  
YAMAHA

**ATV-UTV**  
CAN-AM  
GAS GAS  
HONDA  
KAWASAKI  
KTM  
POLARIS  
SUZUKI  
YAMAHA

**PWC**  
KAWASAKI  
POLARIS  
SEA DOO  
YAMAHA

**SNOW**  
ARCTIC CAT  
KAWASAKI  
LYNX  
MOTO-SKI  
POLARIS  
SKI DOO  
YAMAHA

**MOPED & SCOOTER**

**MISC. TECH. SPECIAL**

**CAN-AM**

<b>DS 450</b> 4-Stroke	<b>Piston kit</b> -	<b>Size</b> 97.00	<b>Ring Set</b> -						
---------------------------	------------------------	----------------------	----------------------	--	--	--	--	--	--

**GAS GAS**

<b>Wild HP 300</b> 2-Stroke Please Note: Nicasil Piston Size -Forged Piston	<b>Piston kit</b> 01.7300.A 01.7300.B 01.7300.C '03-05	<b>Size</b> 71.94 71.95 71.96	<b>Ring Set</b> 02.6396 02.6396 02.6396 '03-05  <b>Pin</b> 04.1853.4 '03-05  <b>Clips</b> 05.1812 '03-05		<b>Con. Rod Kit</b> 03.1315 '03-05  <b>S/E Bearing</b> 21.1303 '03-05				
---	--	--	--	--	---	--	--	--	--

**HONDA**

<b>ATC 110</b> 4-Stroke	<b>Piston kit</b> -	<b>Size</b> 52.00	<b>Ring Set</b> -						
----------------------------	------------------------	----------------------	----------------------	--	--	--	--	--	--

<b>ATC 185 S</b> 4-Stroke	<b>Piston kit</b> - 01.1265.125 '80-83	<b>Size</b> 63.50 64.25	<b>Ring Set</b> - -  <b>Pin</b> 04.1550 '80-83  <b>Clips</b> 05.1510 '80-83	<b>Bearing</b> 23.6328C3 '80-83 2x	<b>Con. Rod Kit</b> 03.1253 '80-83  <b>B/E Bearing</b> 22.303816 '80-83				
------------------------------	---	-------------------------------	---	--	---	--	--	--	--

<b>ATC 200 S</b> 4-Stroke	<b>Piston kit</b> -	<b>Size</b> 65.00	<b>Ring Set</b> -	<b>Bearing</b> 23.6328C3 '82-86 2x	<b>Con. Rod Kit</b> 03.1253 '81-86  <b>B/E Bearing</b> 22.303816 '81-86				
------------------------------	------------------------	----------------------	----------------------	--	---	--	--	--	--

Footnotes: \* Bearings Only

	<b>Clutch Cable</b> 53.121007 '08-15	<b>F/W Bearing</b> 23.S115016 '08-15 2x  <b>R/W Bearing</b> 23.S115065 '08-13 23.S116063 '14-15							
--	--	---	--	--	--	--	--	--	--

		<b>F/W Bearing</b> 23.S110035 '03-05 2x	<b>Front Pad Set</b> 37.102202 '03-05 37.102202BX '03-05 Box of 10  <b>Rear Pad Set</b> 37.102202 '03-05 37.102202BX '03-05 Box of 10	<b>Front Sprocket</b> 07.FS73000-12 07.FS73000-13 '03-05  <b>Chain</b> 07.RC520120C '03-05 MX 07.RC520120CG '03-05 MX Gold 07.RC520120XC '03-05 X-Ring 07.RC520120XCG '03-05 X-Ring Gold	<b>Linkage</b> 26.110118 '03-05				
--	--	---	---	---	---------------------------------------	--	--	--	--

		<b>F/W Bearing</b> 23.S113017 '82-85 2x		<b>Chain</b> 07.RC428130C '79-85 MX					
--	--	---	--	---	--	--	--	--	--

		<b>F/W Bearing</b> 23.S113017 '80-83 2x		<b>Chain</b> 07.RC520120C '80-83 MX 07.RC520120CG '80-83 MX Gold 07.RC520120XC '80-83 X-Ring 07.RC520120XCG '80-83 X-Ring Gold					
--	--	---	--	--	--	--	--	--	--

		<b>F/W Bearing</b> 23.S113017 '84-86 2x		<b>Chain</b> 07.RC520120C '81-86 MX 07.RC520120CG '81-86 MX Gold 07.RC520120XC '81-86 X-Ring 07.RC520120XCG '81-86 X-Ring Gold					
--	--	---	--	--	--	--	--	--	--

**DIRT**  
APRILIA  
BETA  
BMW  
GAS GAS  
HONDA  
HUSABERG  
HUSQVARNA  
KAWASAKI  
KTM  
MOTO TM  
RIEJU  
SHERCO  
SUZUKI  
YAMAHA

**STREET**  
APRILIA  
CAGIVA  
HONDA  
KAWASAKI  
KTM  
SUZUKI  
YAMAHA

**ATV-UTV**  
CAN-AM  
GAS GAS  
HONDA  
KAWASAKI  
KTM  
POLARIS  
SUZUKI  
YAMAHA

**PWC**  
KAWASAKI  
POLARIS  
SEA DOO  
YAMAHA

**SNOW**  
ARCTIC CAT  
KAWASAKI  
LYNX  
MOTO-SKI  
POLARIS  
SKI DOO  
YAMAHA

**MOPED & SCOOTER**

**MISC. TECH. SPECIAL**



### HONDA

**DIRT**  
APRILIA  
BETA  
BMW  
GAS GAS  
HONDA  
HUSABERG  
HUSQVARNA  
KAWASAKI  
KTM  
MOTO TM  
RIEJU  
SHERCO  
SUZUKI  
YAMAHA

**STREET**  
APRILIA  
CAGIVA  
HONDA  
KAWASAKI  
KTM  
SUZUKI  
YAMAHA

**ATV-UTV**  
CAN-AM  
GAS GAS  
HONDA  
KAWASAKI  
KTM  
KYMCO  
PGO  
POLARIS  
SUZUKI  
YAMAHA

**PWC**  
KAWASAKI  
POLARIS  
SEA DOO  
YAMAHA

**SNOW**  
ARCTIC CAT  
KAWASAKI  
LYNX  
MOTO-SKI  
POLARIS  
SKI DOO  
YAMAHA

**MOPED & SCOOTER**

**MISC. TECH. SPECIAL**

<b>ATC 200 X</b> 4-Stroke	<b>Piston kit</b> -	<b>Size</b> 65.00	<b>Ring Set</b> -	<b>Bearing</b> 23.6328C3 '86-87 2x					
<b>TRX 200</b> 4-Stroke	<b>Piston kit</b> -	<b>Size</b> 65.00	<b>Ring Set</b> -	<b>Bearing</b> 23.6328C3 '84 2x	<b>Con. Rod Kit</b> 03.1253 '84  <b>B/E Bearing</b> 22.303816 '84				
<b>TRX 200 SX</b> 4-Stroke	<b>Piston kit</b> -	<b>Size</b> 65.00	<b>Ring Set</b> -	<b>Bearing</b> 23.6328C3 '86-97 2x		<b>Top-End</b> 35.1268 '86-97			
<b>TRX 200 D</b> 4-Stroke	<b>Piston kit</b> 01.1272.150 '90-97	<b>Size</b> 66.50	<b>Ring Set</b> - '90-97  <b>Pin</b> 04.1550 '90-97  <b>Clips</b> 05.1510 '90-97	<b>Bearing</b> 23.6328C3 '90-97 2x		<b>Top-End</b> 35.1268 '90-97			

Footnotes: \* Bearings Only

<b>Clutch Cable</b> 53.120010 '83-85	<b>Friction Set</b> 16.S11001 '83-87  <b>Steel Set</b> 16.S11002 '83-85	<b>F/W Bearing</b> 23.S113017 '86-87 2x	<b>Front Pad Set</b> 37.200802 '83-87 37.200802BX '83-87 Box of 10  <b>Rear Pad Set</b> 37.200802 '83-87 37.200802BX '83-87 Box of 10  <b>Front Caliper Rebuild Kit</b> 37.63038 '86-87  <b>Rear Caliper Rebuild Kit</b> 37.63038 '86-87  <b>Front Master Cylinder Rebuild Kit</b> 37.910004 '86-87  <b>Rear Master Cylinder Rebuild Kit</b> 37.910003 '86-87	<b>Chain</b> 07.RC520120C '83-87 MX 07.RC520120CG '83-87 MX Gold 07.RC520120XC '83-87 X-Ring 07.RC520120XCG '83-87 X-Ring Gold					
						<b>Swingarm</b> 26.210056 '84			
			<b>Front Master Cylinder Rebuild Kit</b> 37.910004 '86-88	<b>Chain</b> 07.RC520120C '85-97 MX 07.RC520120CG '85-97 MX Gold 07.RC520120XC '85-97 X-Ring 07.RC520120XCG '85-97 X-Ring Gold					
		<b>F/W Bearing</b> 23.S115010 '90-97 2x  <b>R/W Bearing</b> 23.S111024 '90-97	<b>Front Master Cylinder Rebuild Kit</b> 37.910004 '90-97	<b>Chain</b> 07.RC520120C '90-97 MX 07.RC520120CG '90-97 MX Gold 07.RC520120XC '90-97 X-Ring 07.RC520120XCG '90-97 X-Ring Gold		<b>Lower A-Arm</b> 26.510038 '90-97  <b>Upper A-Arm</b> 26.510038 '90-97			

**DIRT**  
APRILIA  
BETA  
BMW  
GAS GAS  
HONDA  
HUSABERG  
HUSQVARNA  
KAWASAKI  
KTM  
MOTO TM  
RIEJU  
SHERCO  
SUZUKI  
YAMAHA

**STREET**  
APRILIA  
CAGIVA  
HONDA  
KAWASAKI  
KTM  
SUZUKI  
YAMAHA

**ATV-UTV**  
CAN-AM  
GAS GAS  
HONDA  
KAWASAKI  
KTM  
KYMCO  
PGO  
POLARIS  
SUZUKI  
YAMAHA

**PWC**  
KAWASAKI  
POLARIS  
SEA DOO  
YAMAHA

**SNOW**  
ARCTIC CAT  
KAWASAKI  
LYNX  
MOTO-SKI  
POLARIS  
SKI DOO  
YAMAHA

**MOPED & SCOOTER**

**MISC. TECH. SPECIAL**



### HONDA

**DIRT**  
 APRILIA  
 BETA  
 BMW  
 GAS GAS  
 HONDA  
 HUSABERG  
 HUSQVARNA  
 KAWASAKI  
 KTM  
 MOTO TM  
 RIEJU  
 SHERCO  
 SUZUKI  
 YAMAHA

**STREET**  
 APRILIA  
 CAGIVA  
 HONDA  
 KAWASAKI  
 KTM  
 SUZUKI  
 YAMAHA

**ATV-UTV**  
 CAN-AM  
 GAS GAS  
 HONDA  
 KAWASAKI  
 KTM  
 KYMCO  
 PGO  
 POLARIS  
 SUZUKI  
 YAMAHA

**PWC**  
 KAWASAKI  
 POLARIS  
 SEA DOO  
 YAMAHA

**SNOW**  
 ARCTIC CAT  
 KAWASAKI  
 LYNX  
 MOTO-SKI  
 POLARIS  
 SKI DOO  
 YAMAHA

**MOPED & SCOOTER**

**MISC. TECH. SPECIAL**

Model	Piston kit	Size (mm)	Ring Set	Oilseal Set	Con. Rod Kit	Top-End		
ATC 250 R 2-Stroke	01.1309.000	66.00	-	42.1365	03.1315	35.1386		
	01.1309.050	66.50	-	'85-86	'85-86	'85-86		
TRX 250 R 2-Stroke	01.1309.100	67.00	-	-	S/E Bearing	-		
	01.1309.150	67.50	02.1309.150	-	21.1303	-		
	01.1309.200	68.00	-	-	'85	-		
	'85-86		'85-86		21.1316	-		
			<b>Pin</b>		'86	-		
			04.1856		B/E Bearing	-		
			'85-86		22.243117F	-		
			<b>Clips</b>		'85-86	-		
			05.1812		Crankpin	-		
			'85-86		06.2459.6	-		
				'85-86				
ATC 250 R 2-Stroke	01.1309.000	66.00	-	Crank Bearing & Seal Kit	03.1315	35.1386		
	01.1309.050	66.50	-	23.CBS13087	'85-86	'86-89		
	01.1309.100	67.30	-	'87-89	03.1300	-		
	01.1309.150	67.50	02.1309.150	-	'87-89	-		
	01.1309.200	68.00	-	<b>Bearing</b>	S/E Bearing	-		
	'85-86		'85-86	23.6328C3	21.1303	-		
			02.1300.000	'87-89 2x	'85	-		
			66.50	<b>Oilseal Set</b>	21.1316	-		
			67.00	42.1365	'86	-		
			67.50	'86-89	21.1303	-		
		68.00	-	'87-89	-			
			<b>Pin</b>	B/E Bearing	-			
		04.1856		22.243117F	-			
		'85-86		'85-86	-			
		04.1850		22.243117	-			
		'87-89		'87-89	-			
		<b>Clips</b>		Crankpin	-			
		05.1812		06.2459.6	-			
		'85-89		'85-89	-			

Footnotes: \* Bearings Only

Model	F/W Bearing	Front Pad Set	Chain	Lower A-Arm	Rear Shock Seal Head Kit
ATC 250 R 2-Stroke	23.S113017	37.208002	07.RC520120C	26.510019	26.810006
	'81-86 2x	'85-86	'81-86 MX	'87-89	'86-89
	R/W Bearing	37.208002BX	07.RC520120CG		
	23.S113020	'85-86 Box of 10	'81-86 MX Gold		
	'85-86		07.RC520120XC		
		<b>Rear Pad Set</b>	'81-86 X-Ring		
		37.208002	07.RC520120XCG		
		'85-86	'81-86 X-Ring Gold		
		37.208002BX			
		'85-86 Box of 10			
TRX 250 R 2-Stroke	53.110024	37.105302	07.RC520120C	26.510019	26.810006
	'85-87	'86-89	'85-89 MX	'87-89	'86-89
	17.CS14007	37.105302BX	07.RC520120CG		
	'85-89	'86-89	'81-86 MX Gold		
		37.105302	07.RC520120XC		
		'86-89	'85-89 X-Ring		
		37.105302BX	07.RC520120XCG		
		'86-89 2x	'81-86 X-Ring Gold		
ATC 250 R 2-Stroke	57.1316	37.208002	07.RC520120C	26.510019	26.810006
	'86-89	'86-89	'85-89 MX	'87-89	'86-89
		37.208002BX	07.RC520120CG		
		'86-89 Box of 10	'81-86 MX Gold		
			07.RC520120XC		
		<b>Rear Pad Set</b>	'85-89 X-Ring		
		37.208002	07.RC520120XCG		
		'86-89	'81-86 X-Ring Gold		
		37.208002BX			
		'86-89 Box of 10			
ATC 250 R 2-Stroke	37.910004	37.63007	07.RC520120C	26.510019	26.810006
	'85-86	'86-89	'85-89 MX	'87-89	'86-89
		37.63007	07.RC520120CG		
		'86-89	'81-86 MX Gold		
		37.63007	07.RC520120XC		
		'86-89	'85-89 X-Ring		
		37.63016	07.RC520120XCG		
		'86-89	'81-86 X-Ring Gold		
		37.63016			
		'86-89			
ATC 250 R 2-Stroke	37.910004	37.63007	07.RC520120C	26.510019	26.810006
	'86-89	'86-89	'85-89 MX	'87-89	'86-89
		37.63007	07.RC520120CG		
		'86-89	'81-86 MX Gold		
		37.63007	07.RC520120XC		
		'86-89	'85-89 X-Ring		
		37.63016	07.RC520120XCG		
		'86-89	'81-86 X-Ring Gold		
		37.63016			
		'86-89			

**DIRT**  
 APRILIA  
 BETA  
 BMW  
 GAS GAS  
 HONDA  
 HUSABERG  
 HUSQVARNA  
 KAWASAKI  
 KTM  
 MOTO TM  
 RIEJU  
 SHERCO  
 SUZUKI  
 YAMAHA

**STREET**  
 APRILIA  
 CAGIVA  
 HONDA  
 KAWASAKI  
 KTM  
 SUZUKI  
 YAMAHA

**ATV-UTV**  
 CAN-AM  
 GAS GAS  
 HONDA  
 KAWASAKI  
 KTM  
 KYMCO  
 PGO  
 POLARIS  
 SUZUKI  
 YAMAHA

**PWC**  
 KAWASAKI  
 POLARIS  
 SEA DOO  
 YAMAHA

**SNOW**  
 ARCTIC CAT  
 KAWASAKI  
 LYNX  
 MOTO-SKI  
 POLARIS  
 SKI DOO  
 YAMAHA

**MOPED & SCOOTER**

**MISC. TECH. SPECIAL**







### HONDA

**DIRT**  
APRILIA  
BETA  
BMW  
GAS GAS  
HONDA  
HUSABERG  
HUSQVARNA  
KAWASAKI  
KTM  
MOTO TM  
RIEJU  
SHERCO  
SUZUKI  
YAMAHA

**STREET**  
APRILIA  
CAGIVA  
HONDA  
KAWASAKI  
KTM  
SUZUKI  
YAMAHA

**ATV-UTV**  
CAN-AM  
GAS GAS  
HONDA  
KAWASAKI  
KTM  
KYMCO  
PGO  
POLARIS  
SUZUKI  
YAMAHA

**PWC**  
KAWASAKI  
POLARIS  
SEA DOO  
YAMAHA

**SNOW**  
ARCTIC CAT  
KAWASAKI  
LYNX  
MOTO-SKI  
POLARIS  
SKI DOO  
YAMAHA

**MOPED & SCOOTER**

**MISC. TECH. SPECIAL**

<b>TRX 250 X</b> 4-Stroke -Std. Compression 10.5:1	<b>Piston kit</b> -	<b>Size</b> 74.00	<b>Ring Set</b> -	<b>Bearing</b> 23.6328C3 '87-92 2x		<b>Top-End</b> 35.1430 '87-92		
<b>TRX 250 Recon</b> 4-Stroke -Std. Compression 10.5:1	<b>Piston kit</b> -	<b>Size</b> 68.50	<b>Ring Set</b> -	<b>Bearing</b> 23.6207C3 '02-23 2x		<b>Top-End</b> 35.1301 '02-23	<b>Cam Chain</b> 31.1480 '02-23	
<b>TRX 250 EX/X Sportrax</b> 4-Stroke -Std. Compression 10.5:1	<b>Piston kit</b> -	<b>Size</b> 68.50	<b>Ring Set</b> -	<b>Bearing</b> 23.6207C3 '01-23 2x		<b>Top-End</b> 35.1301 '01-23	<b>Cam Chain</b> 31.1480 '01-23	<b>Valve Seal</b> 35.VS001 '01-23 2x Intake 35.VS001 '01-23 2x Exhaust
<b>TRX 300 Fourtrax</b> 4-Stroke	<b>Piston kit</b> -	<b>Size</b> 74.00	<b>Ring Set</b> -			<b>Top-End</b> 35.1440 '88-00		

Footnotes: \* Bearings Only

<b>Air Filter</b> 52.13087 '87-92		<b>F/W Bearing</b> 23.S110035 '87-92 2x	<b>Frontbrake Disc</b> 37.BD11404 '86-92 2x	<b>Chain</b> 07.RC520120C '87-92 MX 07.RC520120CG '87-92 MX Gold 07.RC520120XC '87-92 X-Ring 07.RC520120XCG '87-92 X-Ring Gold				
<b>Throttle Cable</b> 53.110024 '87-92		<b>R/W Bearing</b> 23.S113020 '87-92	<b>Front Pad Set</b> 37.200802 '87-92 37.200802BX '87-92 Box of 10	<b>Lower Chain Roller</b> 33.0001 '87-92				
<b>Oil Filter</b> 54.44113 '87-92 1-Pce. 54.44113-50 '87-92 50-Pcs.			<b>Rear Pad Set</b> 37.200802 '87-92 37.200802BX '87-92 Box of 10					
			<b>Front Caliper Rebuild Kit</b> 37.63007 '87 37.63020 '88-92					
			<b>Rear Caliper Rebuild Kit</b> 37.63038 '87-92					
			<b>Front Master Cylinder Rebuild Kit</b> 37.910004 '87-92					
			<b>Rear Master Cylinder Rebuild Kit</b> 37.910003 '87-88 37.910007 '91-92					
<b>Air Filter</b> 52.13097 '02-23		<b>F/W Bearing</b> 23.S115010 '02-23 2x	<b>Front Master Cylinder Rebuild Kit</b> 37.910004 '02-23		<b>Swingarm</b> 26.210056 '02-23	<b>Lower A-Arm</b> 26.510038 '02-18		<b>Upper A-Arm</b> 26.510038 '02-18
		<b>R/W Bearing</b> 23.S110034 '02-23						
<b>Air Filter</b> 52.13097 '01-23		<b>F/W Bearing</b> 23.S110083 '01-23 2x	<b>Frontbrake Disc</b> 37.BD11404 '01-14 2x		<b>Swingarm</b> 26.210056 '01-23	<b>Lower A-Arm</b> 26.510038 '01-17		<b>Upper A-Arm</b> 26.510038 '01-17
		<b>R/W Bearing</b> 23.S110034 '01-23	<b>Front Pad Set</b> 37.200802 '01-23 Left 37.200802 '01-23 Right 37.200802BX '01-23 Box of 10					
			<b>Front Caliper Rebuild Kit</b> 37.63020 '01-23					
			<b>Front Master Cylinder Rebuild Kit</b> 37.910004 '01-23					
<b>Air Filter</b> 52.13088 '88-91 + '95-00		<b>F/W Bearing</b> 23.S110035 '88-92 2x 23.S111012 '93-00 2x	<b>Front Master Cylinder Rebuild Kit</b> 37.910004 '88-00 37.910012 '88-00 4x4		<b>Swingarm</b> 26.210056 '88-00	<b>Lower A-Arm</b> 26.510038 '88-00		<b>Upper A-Arm</b> 26.510038 '93-00
<b>Oil Filter</b> 54.44113 '88-00 1-Pce. 54.44113-50 '88-00 50-Pcs.		<b>R/W Bearing</b> 23.S111023 '88-00						

**DIRT**  
APRILIA  
BETA  
BMW  
GAS GAS  
HONDA  
HUSABERG  
HUSQVARNA  
KAWASAKI  
KTM  
MOTO TM  
RIEJU  
SHERCO  
SUZUKI  
YAMAHA

**STREET**  
APRILIA  
CAGIVA  
HONDA  
KAWASAKI  
KTM  
SUZUKI  
YAMAHA

**ATV-UTV**  
CAN-AM  
GAS GAS  
HONDA  
KAWASAKI  
KTM  
KYMCO  
PGO  
POLARIS  
SUZUKI  
YAMAHA

**PWC**  
KAWASAKI  
POLARIS  
SEA DOO  
YAMAHA

**SNOW**  
ARCTIC CAT  
KAWASAKI  
LYNX  
MOTO-SKI  
POLARIS  
SKI DOO  
YAMAHA

**MOPED & SCOOTER**

**MISC. TECH. SPECIAL**



### HONDA

**DIRT**  
APRILIA  
BETA  
BMW  
GAS GAS  
HONDA  
HUSABERG  
HUSQVARNA  
KAWASAKI  
KTM  
MOTO TM  
RIEJU  
SHERCO  
SUZUKI  
YAMAHA

**STREET**  
APRILIA  
CAGIVA  
HONDA  
KAWASAKI  
KTM  
SUZUKI  
YAMAHA

**ATV-UTV**  
CAN-AM  
GAS GAS  
HONDA  
KAWASAKI  
KTM  
KYMCO  
PGO  
POLARIS  
SUZUKI  
YAMAHA

**PWC**  
KAWASAKI  
POLARIS  
SEA DOO  
YAMAHA

**SNOW**  
ARCTIC CAT  
KAWASAKI  
LYNX  
MOTO-SKI  
POLARIS  
SKI DOO  
YAMAHA

**MOPED & SCOOTER**

**MISC. TECH. SPECIAL**

<b>TRX 300 EX</b> 4-Stroke	<b>Piston kit</b> 01.1432.025 01.1432.125 '93-08	<b>Size</b> 74.25 75.25	<b>Ring Set</b> - -  <b>Clips</b> 05.1710 '88-08	<b>Bearing</b> 23.DG407618 '93-08 1x Left		<b>Top-End</b> 35.1430 '93-08	<b>Cam Chain</b> 31.1393 '93-08	<b>Valve Seal</b> 35.VS001 '93-08 4x
<b>TRX 300 X</b> 4-Stroke	<b>Piston kit</b> 01.1432.025 01.1432.125 '09	<b>Size</b> 74.25 75.25	<b>Ring Set</b> - -  <b>Clips</b> 05.1710 '09	<b>Bearing</b> 23.DG407618 '09 1x Left		<b>Top-End</b> 35.1430 '09	<b>Cam Chain</b> 31.1393 '09	<b>Valve Seal</b> 35.VS001 '09 4x

Footnotes: \* Bearings Only

<b>Air Filter</b> 52.13087 '93-08		<b>F/W Bearing</b> 23.S110035 '93-08 2x	<b>Frontbrake Disc</b> 37.BD11404 '93-08 2x	<b>Chain</b> 07.RC520120C '93-08 MX 07.RC520120CG '93-08 MX Gold 07.RC520120XC '93-08 X-Ring 07.RC520120XCG '93-08 X-Ring Gold				
<b>Main Jet</b> 45.100-225 '93-08 Keihin		<b>R/W Bearing</b> 23.S113020 '93-08	<b>Front Pad Set</b> 37.200802 '93-08 37.200802BX '93-08 Box of 10	<b>Lower Chain Roller</b> 33.0001 '93-08				
<b>Pilot Jet</b> 46.040-085 '93-08 Keihin			<b>Rear Pad Set</b> 37.200802 '93-08 37.200802BX '93-08 Box of 10					
<b>Throttle Cable</b> 53.110024 '93-08			<b>Front Caliper Rebuild Kit</b> 37.63020 '93-08					
<b>Oil Filter</b> 54.44113 '93-08 1-Pce. 54.44113-50 '93-08 50-Pcs.			<b>Rear Caliper Rebuild Kit</b> 37.63038 '93-08					
			<b>Front Master Cylinder Rebuild Kit</b> 37.910004 '93-08					
			<b>Rear Master Cylinder Rebuild Kit</b> 37.910007 '93-08					
<b>Air Filter</b> 52.13087 '09		<b>F/W Bearing</b> 23.S110035 '09 2x	<b>Frontbrake Disc</b> 37.BD11404 '09 2x	<b>Chain</b> 07.RC520120C '09 MX 07.RC520120CG '09 MX Gold 07.RC520120XC '09 X-Ring 07.RC520120XCG '09 X-Ring Gold				
<b>Main Jet</b> 45.100-225 '09 Keihin		<b>R/W Bearing</b> 23.S113020 '09	<b>Front Pad Set</b> 37.200802 '09 37.200802BX '09 Box of 10	<b>Lower Chain Roller</b> 33.0001 '09				
<b>Pilot Jet</b> 46.040-085 '09 Keihin			<b>Rear Pad Set</b> 37.200802 '09 37.200802BX '09 Box of 10					
<b>Throttle Cable</b> 53.110024 '09			<b>Front Caliper Rebuild Kit</b> 37.63020 '09					
<b>Oil Filter</b> 54.44113 '09 1-Pce. 54.44113-50 '09 50-Pcs.			<b>Rear Caliper Rebuild Kit</b> 37.63038 '09					
			<b>Front Master Cylinder Rebuild Kit</b> 37.910004 '09					
			<b>Rear Master Cylinder Rebuild Kit</b> 37.910007 '09					

**DIRT**  
APRILIA  
BETA  
BMW  
GAS GAS  
HONDA  
HUSABERG  
HUSQVARNA  
KAWASAKI  
KTM  
MOTO TM  
RIEJU  
SHERCO  
SUZUKI  
YAMAHA

**STREET**  
APRILIA  
CAGIVA  
HONDA  
KAWASAKI  
KTM  
SUZUKI  
YAMAHA

**ATV-UTV**  
CAN-AM  
GAS GAS  
HONDA  
KAWASAKI  
KTM  
KYMCO  
PGO  
POLARIS  
SUZUKI  
YAMAHA

**PWC**  
KAWASAKI  
POLARIS  
SEA DOO  
YAMAHA

**SNOW**  
ARCTIC CAT  
KAWASAKI  
LYNX  
MOTO-SKI  
POLARIS  
SKI DOO  
YAMAHA

**MOPED & SCOOTER**

**MISC. TECH. SPECIAL**



### HONDA

**DIRT**  
 APRILIA  
 BETA  
 BMW  
 GAS GAS  
 HONDA  
 HUSABERG  
 HUSQVARNA  
 KAWASAKI  
 KTM  
 MOTO TM  
 RIEJU  
 SHERCO  
 SUZUKI  
 YAMAHA

**STREET**  
 APRILIA  
 CAGIVA  
 HONDA  
 KAWASAKI  
 KTM  
 SUZUKI  
 YAMAHA

**ATV-UTV**  
 CAN-AM  
 GAS GAS  
 HONDA  
 KAWASAKI  
 KTM  
 KYMCO  
 PGO  
 POLARIS  
 SUZUKI  
 YAMAHA

**PWC**  
 KAWASAKI  
 POLARIS  
 SEA DOO  
 YAMAHA

**SNOW**  
 ARCTIC CAT  
 KAWASAKI  
 LYNX  
 MOTO-SKI  
 POLARIS  
 SKI DOO  
 YAMAHA

**MOPED & SCOOTER**

**MISC. TECH. SPECIAL**

Model	Piston kit	Size (mm)	Ring Set	Crankshaft Parts	Connecting Rod Parts	Gaskets	Valve Train Parts I	Valve Train Parts II
<b>TRX 350 Rancher</b> 4-Stroke	01.1480.000 01.1480.025 01.1480.050 01.1480.100 '00-06	78.50 78.75 79.00 79.50	02.1480.000 02.1480.025 02.1480.050 02.1480.100 '00-06					
			<b>Clips</b> 05.1712C '00-06					
<b>TRX 400 Foreman</b> 4-Stroke	01.1485.000 01.1485.025 01.1485.200 '95-03	86.00 86.25 88.00	02.1485.000 02.1485.025 02.1485.200 '95-03					
<b>TRX 400 EX</b> 4-Stroke -Std. Compression 10.0:1	01.1495.000 01.1495.025 01.1495.050 01.1495.100 '99-08	85.00 85.25 85.50 86.00	02.1495.000 02.1495.025 02.1495.050 02.1495.100 '99-08	<b>Crank Bearing &amp; Seal Kit</b> 23.CBS14096* '99-08				
			<b>Clips</b> 05.2013 '99-08	<b>Bearing</b> 23.SCO692C3 '99-08 2x				<b>Valve Seal</b> 35.VS001 '99-08 4x

Footnotes: \* Bearings Only

Model	Air Filter	Clutch Parts	Clutch Plate Sets	Wheel & Steering Parts	Brake Parts	Drive Chain Parts I	Drive Chain Parts II	Suspension Bearing Kits	Suspension Parts
	<b>Air Filter</b> 52.13000 '00-06								
	<b>Oil Filter</b> 54.44113 '00-06 1-Pce. 54.44113-50 '00-06 50-Pcs.								
				<b>F/W Bearing</b> 23.S115013 00-06 FE/FM 2x 23.S115010 00-06 TE/TM 2x	<b>Front Master Cylinder Rebuild Kit</b> 37.910004 '00-03 37.910013 '04-06		<b>Swingarm</b> 26.210056 '00-06	<b>Lower A-Arm</b> 26.510038 '00-06	<b>Upper A-Arm</b> 26.510038 '00-06
				<b>R/W Bearing</b> 23.S110037 '00-06					
	<b>Air Filter</b> 52.13088 '98-03			<b>F/W Bearing</b> 23.S110005 '95-03 2x	<b>Front Master Cylinder Rebuild Kit</b> 37.910012 '95-03		<b>Swingarm</b> 26.210056 '95-03	<b>Lower A-Arm</b> 26.510038 '95-03	<b>Upper A-Arm</b> 26.510038 '95-03
	<b>Oil Filter</b> 54.44113 '95-03 1-Pce. 54.44113-50 '95-03 50-Pcs.			<b>R/W Bearing</b> 23.S110037 '95-03					
	<b>Air Filter</b> 52.14099 '99-08	<b>Basket</b> 17.1499F '99-04 17.1505F '05-08	<b>Friction Set</b> 16.S14017 '99-08	<b>F/W Bearing</b> 23.S110035 '99-01 2x 23.S110083 '02-08 2x	<b>Frontbrake Disc</b> 37.BD11404 '99-08 2x	<b>Front Sprocket</b> 07.FS14096-14 07.FS14096-15 '99-04 07.FS14095-13 07.FS14095-14 07.FS14095-15 '05-08	<b>Swingarm</b> 26.210053 '99-08	<b>FRONT</b> 26.400004 '99-04 26.450019 '05-07	<b>Rear Shock Seal Head Kit</b> 26.810006 '99-08
	<b>Main Jet</b> 45.100-225 '99-08 Keihin	<b>Inner Hub</b> 18.1499 '99-04		<b>R/W Bearing</b> 23.S113020 '99-08	<b>Rearbrake Disc</b> 37.BD21409 '99-08	<b>Chain</b> 07.RC520120C '99-08 MX 07.RC520120CG '99-08 MX Gold 07.RC520120XC '99-08 X-Ring 07.RC520120XCG '99-08 X-Ring Gold	<b>Linkage</b> 26.110048 '99-08	<b>Lower A-Arm</b> 26.510020 '99-08	<b>Upper A-Arm</b> 26.510020 '99-08
	<b>Pilot Jet</b> 46.040-085 '99-08 Keihin	<b>Spring Kit</b> 17.CS14009 '99-08			<b>Front Pad Set</b> 37.200802 '99-08 37.200802BX '99-08 Box of 10		<b>Lower</b> 26.450019 '99-08		
	<b>Throttle Cable</b> 53.110024 '99-04	<b>Cover Gasket</b> 19.G1499 '99-04 19.G1495 '05-08			<b>Rear Pad Set</b> 37.200802 '99-08 37.200802BX '99-08 Box of 10	<b>Lower Chain Roller</b> 33.0001 '99-08	<b>Upper</b> 26.450019 '99-08		
	<b>Oil Filter</b> 54.44113 '99-08 1-Pce. 54.44113-50 '99-08 50-Pcs.				<b>Front Caliper Rebuild Kit</b> 37.63020 '99-08				
					<b>Rear Caliper Rebuild Kit</b> 37.63038 '99-08				
					<b>Front Master Cylinder Rebuild Kit</b> 37.910004 '99-08				
					<b>Rear Master Cylinder Rebuild Kit</b> 37.910003 '99-08				

**DIRT**  
 APRILIA  
 BETA  
 BMW  
 GAS GAS  
 HONDA  
 HUSABERG  
 HUSQVARNA  
 KAWASAKI  
 KTM  
 MOTO TM  
 RIEJU  
 SHERCO  
 SUZUKI  
 YAMAHA

**STREET**  
 APRILIA  
 CAGIVA  
 HONDA  
 KAWASAKI  
 KTM  
 SUZUKI  
 YAMAHA

**ATV-UTV**  
 CAN-AM  
 GAS GAS  
 HONDA  
 KAWASAKI  
 KTM  
 KYMCO  
 PGO  
 POLARIS  
 SUZUKI  
 YAMAHA

**PWC**  
 KAWASAKI  
 POLARIS  
 SEA DOO  
 YAMAHA

**SNOW**  
 ARCTIC CAT  
 KAWASAKI  
 LYNX  
 MOTO-SKI  
 POLARIS  
 SKI DOO  
 YAMAHA

**MOPED & SCOOTER**

**MISC. TECH. SPECIAL**



### HONDA

**DIRT**  
 APRILIA  
 BETA  
 BMW  
 GAS GAS  
 HONDA  
 HUSABERG  
 HUSQVARNA  
 KAWASAKI  
 KTM  
 MOTO TM  
 RIEJU  
 SHERCO  
 SUZUKI  
 YAMAHA

**STREET**  
 APRILIA  
 CAGIVA  
 HONDA  
 KAWASAKI  
 KTM  
 SUZUKI  
 YAMAHA

**ATV-UTV**  
 CAN-AM  
 GAS GAS  
 HONDA  
 KAWASAKI  
 KTM  
 KYMCO  
 PGO  
 POLARIS  
 SUZUKI  
 YAMAHA

**PWC**  
 KAWASAKI  
 POLARIS  
 SEA DOO  
 YAMAHA

**SNOW**  
 ARCTIC CAT  
 KAWASAKI  
 LYNX  
 MOTO-SKI  
 POLARIS  
 SKI DOO  
 YAMAHA

**MOPED & SCOOTER**

**MISC. TECH. SPECIAL**

Model	Piston kit	Size (mm)	Ring Set	Crank Bearing & Seal Kit	Top-End	Cam Chain	Valve
<b>TRX 400 X</b> 4-Stroke -Std. Compression 10.0:1	01.1495.000 01.1495.025 01.1495.050 01.1495.100 '09-14	85.00 85.25 85.50 86.00	02.1495.000 02.1495.025 02.1495.050 02.1495.100 '09-14	23.CBS14096* '09-14  <b>Bearing</b> 23.SCO692C3 '09-14 2x	35.1499 '09-14	31.1496 '09-14	28.1495-1 '09-14 2x Exh. Steel 28.1495-2 '09-14 2x Int. Steel  <b>Valve Seal</b> 35.VS001 '09-14 4x
<b>TRX 420 Rancher</b> 4-Stroke	01.1487.000 01.1487.025 01.1487.050 01.1487.100 01.1487.200 '07-23	86.50 86.75 87.00 87.50 88.50	02.1487.000 02.1487.025 02.1487.050 02.1487.100 02.1487.200 '07-23		35.1489 '09-18	31.1487 '07-23	

Footnotes: \* Bearings Only

Air Filter	Basket	Friction Set	F/W Bearing	Frontbrake Disc	Front Sprocket	Swingarm	Rear Shock Seal Head Kit
52.14099 '09-14  <b>Main Jet</b> 45.100-225 '09-14 Keihin  <b>Pilot Jet</b> 46.040-085 '09-14 Keihin  <b>Oil Filter</b> 54.44113 '09-14 1-Pce. 54.44113-50 '09-14 50-Pcs.	17.1505F '09-14  <b>Spring Kit</b> 17.CS14009 '09-14  <b>Cover Gasket</b> 19.G1495 '09-14	16.S14017 '09-14	23.S110083 '09-14 2x  <b>R/W Bearing</b> 23.S113020 '09-14	37.BD11404 '09-14 2x  <b>Rearbrake Disc</b> 37.BD21409 '09-14  <b>Front Pad Set</b> 37.200802 '09-14 2x 37.200802BX '09-14 Box of 10  <b>Rear Pad Set</b> 37.200802 '09-14 37.200802BX '09-14 Box of 10  <b>Front Caliper Rebuild Kit</b> 37.63020 '09-14  <b>Rear Caliper Rebuild Kit</b> 37.63038 '09-14  <b>Front Master Cylinder Rebuild Kit</b> 37.910004 '09-14  <b>Rear Master Cylinder Rebuild Kit</b> 37.910003 '09-14	07.FS14095-13 07.FS14095-14 07.FS14095-15 '09-14  <b>Chain</b> 07.RC520120C '09-14 MX 07.RC520120CG '09-14 MX Gold 07.RC520120XC '09-14 X-Ring 07.RC520120XCG '09-14 X-Ring Gold  <b>Lower Chain Roller</b> 33.0001 '09-14	26.210053 '09-14  <b>Linkage</b> 26.110048 '09-14  <b>Lower</b> 26.450019 '09-14  <b>Upper</b> 26.450019 '09-14	26.810006 '09-14
52.14007 '07-12  <b>Oil Filter</b> 54.44113 '07-15 1-Pce. 54.44113-50 '07-15 50-Pcs.  <b>Water Pump Rebuild Kit</b> 57.1428 '09-16 FA 57.1427 '07-18 FA 57.1427 '07-16 TE 57.1427 '07-18 FE/FM/TM			23.S110003 '07-14 FA 2x 23.S116088 '15-18 FA 2x 23.S110003 07-13 FE/FM 2x 23.S116088 '14-18 FE/FM 2x 23.S115030 07-13 TE/TM 2x 23.S116088 '14-18 TE/TM 2x  <b>R/W Bearing</b> 23.S116024 '09-17 FA IRS 2x 23.S116089 '14-18 FA 1x 23.S115080 07-13 FE/FM 1x 23.S116089 14-18 FE /FM 1x 23.S115080 07-13 TE/TM 1x 23.S116089 '14-18 TE/TM 1x	37.200802 '07-18 37.200802BX '07-18 Box of 10  <b>Front Caliper Rebuild Kit</b> 37.63019 '09-18  <b>Rear Caliper Rebuild Kit</b> 37.63051 '09-18 FA/FPA  <b>Front Master Cylinder Rebuild Kit</b> 37.910013 '07-18  <b>Rear Master Cylinder Rebuild Kit</b> 37.910014 '09-18 FA 37.910014 '09-14 FPA IRS	26.210203 '07-13 26.210211 '14-18  <b>Lower A-Arm</b> 26.510038 '07-18  <b>Upper A-Arm</b> 26.510038 '07-18		

**DIRT**  
 APRILIA  
 BETA  
 BMW  
 GAS GAS  
 HONDA  
 HUSABERG  
 HUSQVARNA  
 KAWASAKI  
 KTM  
 MOTO TM  
 RIEJU  
 SHERCO  
 SUZUKI  
 YAMAHA

**STREET**  
 APRILIA  
 CAGIVA  
 HONDA  
 KAWASAKI  
 KTM  
 SUZUKI  
 YAMAHA

**ATV-UTV**  
 CAN-AM  
 GAS GAS  
 HONDA  
 KAWASAKI  
 KTM  
 KYMCO  
 PGO  
 POLARIS  
 SUZUKI  
 YAMAHA

**PWC**  
 KAWASAKI  
 POLARIS  
 SEA DOO  
 YAMAHA

**SNOW**  
 ARCTIC CAT  
 KAWASAKI  
 LYNX  
 MOTO-SKI  
 POLARIS  
 SKI DOO  
 YAMAHA

**MOPED & SCOOTER**

**MISC. TECH. SPECIAL**



### HONDA

**DIRT**  
APRILIA  
BETA  
BMW  
GAS GAS  
HONDA  
HUSABERG  
HUSQVARNA  
KAWASAKI  
KTM  
MOTO TM  
RIEJU  
SHERCO  
SUZUKI  
YAMAHA

**STREET**  
APRILIA  
CAGIVA  
HONDA  
KAWASAKI  
KTM  
SUZUKI  
YAMAHA

**ATV-UTV**  
CAN-AM  
GAS GAS  
HONDA  
KAWASAKI  
KTM  
KYMCO  
PGO  
POLARIS  
SUZUKI  
YAMAHA

**PWC**  
KAWASAKI  
POLARIS  
SEA DOO  
YAMAHA

**SNOW**  
ARCTIC CAT  
KAWASAKI  
LYNX  
MOTO-SKI  
POLARIS  
SKI DOO  
YAMAHA

**MOPED & SCOOTER**

**MISC. TECH. SPECIAL**

Model	Piston kit	Size (mm)	Ring Set	Con. Rod Kit	Complete	Cam Chain	Valve Seal
<b>TRX 450 R</b> 4-Stroke Please Note: Nicasil Piston Size	01.1494.100 '04-05	95.00	02.1494.100 '04-05	03.1405 '06-09	34.1494 '04-05 34.1496 '06-09	31.1493 '04-05 31.1403 '06-09	35.VS001 '04-05 4x 35.VS001 '06-09 2x Intake 35.VS004 '06-09 2x Exhaust
Replating or Cylinder Sleaving Required for Oversizes	01.1496.A 01.1496.B 01.1496.C '06-09	95.96 95.97 95.98	02.1496 02.1496 02.1496 '06-09		<b>Top-End</b> 35.1494 '04-05 35.1496 '06-09	<b>Valve Shim Assortment</b> 29.VSA948 '04-09 29.VSA948-2 '04-09	
Please Note: Nicasil Piston Size -Std. Compression 12.0:1	<b>High Compression</b> 01.1497.A '06-09	95.96	02.1496 '06-09				
Please Note: Nicasil Piston Size -High Compression 13.5:1 -Forged Piston			<b>Pin</b> 04.1950.5 '06-09  <b>Clips</b> 05.1912 '06-09				
<b>TRX 450 ER</b> 4-Stroke Please Note: Nicasil Piston Size -Std. Compression 12.0:1	01.1496.A 01.1496.B 01.1496.C '06-14	95.96 95.97 95.98	02.1496 02.1496 02.1496 '06-14	03.1405 '06-09	34.1496 '06-14	31.1403 '06-14	35.VS001 '06-14 2x Intake 35.VS004 '06-14 2x Exhaust
Please Note: Nicasil Piston Size -High Compression 13.5:1 -Forged Piston	<b>High Compression</b> 01.1497.A '06-14	95.96	02.1496 '06-14		<b>Top-End</b> 35.1496 '06-14	<b>Valve Shim Assortment</b> 29.VSA948 '04-14 29.VSA948-2 '04-14	
			<b>Pin</b> 04.1950.5 '06-14  <b>Clips</b> 05.1912 '06-14				

Footnotes: \* Bearings Only

Model	Air Filter	Pressure Plate	Complete Plate Set	F/W Bearing	Frontbrake Disc	Front Sprocket	Swingarm	FRONT
	52.14005 '04-05	18.P1392 '04-09	16.CPS14004 '04-09	23.S110083 '04-09 2x	37.BD11404 '04-09 2x	07.FS13088-12 07.FS13088-13 07.FS13088-14 07.FS13088-15 '04-09	26.210123 '04-09	26.450019 '04-09
<b>Main Jet</b> 45.100-225 '04-09 Keihin	<b>Spring Kit</b> 17.CS13006 '04-09	<b>Friction Set</b> 16.S14022 '04-09	<b>R/W Bearing</b> 23.S114079 '04-09	<b>Rearbrake Disc</b> 37.BD21404 '04-09	<b>Chain</b> 07.RC520120C '04-09 MX 07.RC520120CG '04-09 MX Gold 07.RC520120XC '04-09 X-Ring 07.RC520120XCG '04-09 X-Ring Gold	<b>Linkage</b> 26.110121 '04-09	<b>Lower</b> 26.450019 '04-09	
<b>Pilot Jet</b> 46.040-085 '04-09 Keihin	<b>Cover Gasket</b> 19.G1402 '04-09	<b>Steel Set</b> 16.S14016 '04-09		<b>Front Pad Set</b> 37.103202 '04-09 37.103202BX '04-09 Box of 10	<b>Lower Chain Roller</b> 33.0001 '04-05 33.0010 '06-09	<b>Upper</b> 26.450019 '04-09		
<b>Throttle Cable</b> 53.110059 '04-09	<b>Clutch Cable</b> 53.120004 '04-09			<b>Rear Pad Set</b> 37.208502 '04-09 37.208502BX '04-09 Box of 10	<b>Countershaft Seal Kit</b> 26.640034 '04-09			
<b>Oil Filter</b> 54.13116 '04-09 1-Pce. 54.13116-50 '04-09 50-Pcs.				<b>Front Caliper Rebuild Kit</b> 37.63017 '04-09				
<b>Water Pump Rebuild Kit</b> 57.1424 '04-05 57.1426 '06-09				<b>Rear Caliper Rebuild Kit</b> 37.63052 '04-09				
				<b>Front Master Cylinder Rebuild Kit</b> 37.910011 '04-09				
				<b>Rear Master Cylinder Rebuild Kit</b> 37.910007 '04-09				
<b>Main Jet</b> 45.100-225 '04-14 Keihin	<b>Pressure Plate</b> 18.P1392 '04-14	<b>Complete Plate Set</b> 16.CPS14004 '04-14	<b>F/W Bearing</b> 23.S110083 '04-14 2x	<b>Frontbrake Disc</b> 37.BD11404 '06-14 2x	<b>Front Sprocket</b> 07.FS13088-12 07.FS13088-13 07.FS13088-14 07.FS13088-15 '04-14	<b>Swingarm</b> 26.210123 '06-14	<b>FRONT</b> 26.450019 '06-14	
<b>Pilot Jet</b> 46.040-085 '04-14 Keihin	<b>Spring Kit</b> 17.CS13006 '04-14	<b>Friction Set</b> 16.S14022 '04-14	<b>R/W Bearing</b> 23.S114079 '04-14	<b>Rearbrake Disc</b> 37.BD21404 '06-14	<b>Chain</b> 07.RC520120C '04-14 MX 07.RC520120CG '04-14 MX Gold 07.RC520120XC '04-14 X-Ring 07.RC520120XCG '04-14 X-Ring Gold	<b>Linkage</b> 26.110121 '06-14	<b>Lower</b> 26.450019 '06-14	
<b>Throttle Cable</b> 53.110059 '06-14	<b>Cover Gasket</b> 19.G1402 '06-14	<b>Friction Set</b> 16.S14016 '04-14		<b>Front Pad Set</b> 37.103202 '04-14 37.103202BX '04-14 Box of 10	<b>Lower Chain Roller</b> 33.0010 '06-14	<b>Upper</b> 26.450019 '06-14		
<b>Oil Filter</b> 54.13116 '04-14 1-Pce. 54.13116-50 '04-14 50-Pcs.	<b>Clutch Cable</b> 53.120004 '06-14			<b>Rear Pad Set</b> 37.208502 '04-14 37.208502BX '04-14 Box of 10	<b>Countershaft Seal Kit</b> 26.640034 '06-14			
<b>Water Pump Rebuild Kit</b> 57.1426 '06-14				<b>Front Caliper Rebuild Kit</b> 37.63017 '06-14				
				<b>Rear Caliper Rebuild Kit</b> 37.63052 '06-14				
				<b>Front Master Cylinder Rebuild Kit</b> 37.910011 '06-14				
				<b>Rear Master Cylinder Rebuild Kit</b> 37.910007 '06-14				

**DIRT**  
APRILIA  
BETA  
BMW  
GAS GAS  
HONDA  
HUSABERG  
HUSQVARNA  
KAWASAKI  
KTM  
MOTO TM  
RIEJU  
SHERCO  
SUZUKI  
YAMAHA

**STREET**  
APRILIA  
CAGIVA  
HONDA  
KAWASAKI  
KTM  
SUZUKI  
YAMAHA

**ATV-UTV**  
CAN-AM  
GAS GAS  
HONDA  
KAWASAKI  
KTM  
KYMCO  
PGO  
POLARIS  
SUZUKI  
YAMAHA

**PWC**  
KAWASAKI  
POLARIS  
SEA DOO  
YAMAHA

**SNOW**  
ARCTIC CAT  
KAWASAKI  
LYNX  
MOTO-SKI  
POLARIS  
SKI DOO  
YAMAHA

**MOPED & SCOOTER**

**MISC. TECH. SPECIAL**



### HONDA

**DIRT**  
APRILIA  
BETA  
BMW  
GAS GAS  
HONDA  
HUSABERG  
HUSQVARNA  
KAWASAKI  
KTM  
MOTO TM  
RIEJU  
SHERCO  
SUZUKI  
YAMAHA

TRX 450 S/ES Foreman 4-Stroke	<b>Piston kit</b>	<b>Size</b>	<b>Ring Set</b>		<b>Top-End</b>	<b>Cam Chain</b>	
	01.1498.000 01.1498.025 01.1498.050 01.1498.100 01.1498.150 01.1498.200 '98-04	90.00 90.25 90.50 91.00 91.50 92.00	02.1498.000 02.1498.025 02.1498.050 02.1498.100 02.1498.150 02.1498.200 '98-04		35.1498 '98-04	31.1485 '98-04	

TRX 500 FA/FGA Rubicon 4-Stroke -Std. Compression 9.2:1	<b>Piston kit</b>	<b>Size</b>	<b>Ring Set</b>		<b>Top-End</b>	<b>Cam Chain</b>	
	01.1501.000 01.1501.050 01.1501.100 '01-14	92.00 92.50 93.00	02.1501.000 02.1501.050 02.1501.100 '01-14		35.1501 '01-14	31.1501 '01-14	

**STREET**  
APRILIA  
CAGIVA  
HONDA  
KAWASAKI  
KTM  
SUZUKI  
YAMAHA

FA = 4WD, Automatic FGA= GPScape, or GPS Equipped	<b>Piston kit</b>	<b>Size</b>	<b>Ring Set</b>		<b>Top-End</b>	<b>Cam Chain</b>	
	01.1501.000 01.1501.050 01.1501.100 '05-11	92.00 92.50 93.00	02.1501.000 02.1501.050 02.1501.100 '05-11		35.1505 '05-11	31.1487 '12-19	

**ATV-UTV**  
CAN-AM  
GAS GAS  
HONDA  
KAWASAKI  
KYMCO  
KTM  
PGO  
POLARIS  
SUZUKI  
YAMAHA

TRX 500 FE/FM Fourtrax Foreman 4-Stroke -Std. Compression 8.5:1	<b>Piston kit</b>	<b>Size</b>	<b>Ring Set</b>		<b>Top-End</b>	<b>Cam Chain</b>	
	01.1501.000 01.1501.050 01.1501.100 '05-11	92.00 92.50 93.00	02.1501.000 02.1501.050 02.1501.100 '05-11		35.1505 '05-11	31.1487 '12-19	

**PWC**  
KAWASAKI  
POLARIS  
SEA DOO  
YAMAHA

TRX 650 F Rincon 4-Stroke -Std. Compression 10.5:1	<b>Piston kit</b>	<b>Size</b>	<b>Ring Set</b>		<b>Top-End</b>	<b>Cam Chain</b>	
	-	100.00	-			31.1603 '03-05	

**SNOW**  
ARCTIC CAT  
KAWASAKI  
LYNX  
MOTO-SKI  
POLARIS  
SKI DOO  
YAMAHA

**MOPED & SCOOTER**

**MISC. TECH. SPECIAL**

**DIRT**  
APRILIA  
BETA  
BMW  
GAS GAS  
HONDA  
HUSABERG  
HUSQVARNA  
KAWASAKI  
KTM  
MOTO TM  
RIEJU  
SHERCO  
SUZUKI  
YAMAHA

<b>Air Filter</b> 52.13088 '98-04		<b>F/W Bearing</b> 23.S110005 '98-04 2x	<b>Front Master Cylinder Rebuild Kit</b> 37.910012 '98-04	<b>Swingarm</b> 26.210056 '98-04	<b>Lower A-Arm</b> 26.510038 '98-04
<b>Oil Filter</b> 54.44113 '98-02 1-Pce. 54.44113-50 '98-02 50-Pcs.		<b>R/W Bearing</b> 23.S110037 '98-04			<b>Upper A-Arm</b> 26.510038 '98-04

<b>Air Filter</b> 52.14099 '01-04 52.15005 '05-14 52.14099 '15-18		<b>F/W Bearing</b> 23.S110005 '01-04 2x 23.S115072 '05-14 2x 23.S116088 '15-18 2x	<b>Front Master Cylinder Rebuild Kit</b> 37.910012 '01-04 37.910013 '05-18	<b>Swingarm</b> 26.210056 '01-17	<b>Lower A-Arm</b> 26.510038 '01-18
	<b>Water Pump Rebuild Kit</b> 57.1427 '15-18		<b>Rear Master Cylinder Rebuild Kit</b> 37.910014 '15-18		

**STREET**  
APRILIA  
CAGIVA  
HONDA  
KAWASAKI  
KTM  
SUZUKI  
YAMAHA

<b>Air Filter</b> 52.15005 '05-09 52.14099 '12-17		<b>F/W Bearing</b> 23.S115072 '05-13 2x 23.S116088 '14-18 2x	<b>Front Master Cylinder Rebuild Kit</b> 37.910013 '05-18	<b>Swingarm</b> 26.210056 '05-11 26.210203 '12-13 26.210211 '14-18	<b>Lower A-Arm</b> 26.510038 '05-18
	<b>Oil Filter</b> 54.44113 '05-16 1-Pce. 54.44113-50 '05-16 50-Pcs.		<b>Front Caliper Rebuild Kit</b> 37.63018 '05-09 37.63019 '12-18		

**ATV-UTV**  
CAN-AM  
GAS GAS  
HONDA  
KAWASAKI  
KYMCO  
KTM  
PGO  
POLARIS  
SUZUKI  
YAMAHA

<b>Air Filter</b> 52.14099 '03-05		<b>F/W Bearing</b> 23.S110005 '03-05 2x	<b>Rear Pad Set</b> 37.208502 '03-05 37.208502BX '03-05 Box of 10	<b>Swingarm</b>	<b>Lower A-Arm</b> 26.510038 '03-05
	<b>Water Pump Rebuild Kit</b> 57.1623 '03-05		<b>Front Master Cylinder Rebuild Kit</b> 37.910013 '03-05		

**SNOW**  
ARCTIC CAT  
KAWASAKI  
LYNX  
MOTO-SKI  
POLARIS  
SKI DOO  
YAMAHA

**MOPED & SCOOTER**

**MISC. TECH. SPECIAL**

Footnotes: \* Bearings Only





### HONDA

**DIRT**  
APRILIA  
BETA  
BMW  
GAS GAS  
HONDA  
HUSABERG  
HUSQVARNA  
KAWASAKI  
KTM  
MOTO TM  
RIEJU  
SHERCO  
SUZUKI  
YAMAHA

<b>TRX 680 FA/FGA Rincon</b> 4-Stroke -Std. Compression 9.2:1 -Fuel Injection	<b>Piston kit</b> 01.1714.000 01.1714.050 01.1714.100 '06-23	<b>Size</b> 102.00 102.50 103.00	<b>Ring Set</b> 02.1714.000 02.1714.050 02.1714.100 '06-23				<b>Cam Chain</b> 31.1603 '06-23	<b>Valve Seal</b> 35.VS001 '06-23 2x Intake 35.VS001 '06-23 2x Exhaust
--	--	---	--	--	--	--	---------------------------------------	--

**STREET**  
APRILIA  
CAGIVA  
HONDA  
KAWASAKI  
KTM  
SUZUKI  
YAMAHA

<b>TRX 700 XX</b> 4-Stroke -Std. Compression 10.0:1 -Forged Piston -Fuel Injection	<b>Piston kit</b> 01.1708.000 01.1708.100 '08-11	<b>Size</b> 102.00 103.00	<b>Ring Set</b> 02.6608 02.1708.100 '08-11				<b>Cam Chain</b> 31.2419 '08-11	<b>Valve Seal</b> 35.VS006 '08-11 2x Intake 35.VS006 '08-11 2x Exhaust
--	---	---------------------------------	---	--	--	--	---------------------------------------	--

**ATV-UTV**  
CAN-AM  
GAS GAS  
HONDA  
KAWASAKI  
KTM  
KYMCO  
PGO  
POLARIS  
SUZUKI  
YAMAHA

			<b>Pin</b> 04.2457.1 '08-11					
			<b>Clips</b> 05.2412 '08-11					

**PWC**  
KAWASAKI  
POLARIS  
SEA DOO  
YAMAHA

--	--	--	--	--	--	--	--	--

**SNOW**  
ARCTIC CAT  
KAWASAKI  
LYNX  
MOTO-SKI  
POLARIS  
SKI DOO  
YAMAHA

<b>MUV 700</b> 4-Stroke -Std. Compression 9.2:1 -Fuel Injection	<b>Piston kit</b> 01.1714.000 01.1714.050 01.1714.100 '10-13	<b>Size</b> 102.00 102.50 103.00	<b>Ring Set</b> 02.1714.000 02.1714.050 02.1714.100 '10-13				<b>Cam Chain</b> 31.1603 '09-13	
--	--	---	--	--	--	--	---------------------------------------	--

**MOPED & SCOOTER**

<b>SXS 700 Pioneer</b> 4-Stroke -Std. Compression 9.2:1 -Fuel Injection	<b>Piston kit</b> 01.1714.000 01.1714.050 01.1714.100 '14-23	<b>Size</b> 102.00 102.50 103.00	<b>Ring Set</b> 02.1714.000 02.1714.050 02.1714.100 '14-23				<b>Cam Chain</b> 31.1603 '14-23	
--	--	---	--	--	--	--	---------------------------------------	--

**MISC. TECH. SPECIAL**

--	--	--	--	--	--	--	--	--

Footnotes: \* Bearings Only

<b>Air Filter</b> 52.15005 '06-23			<b>F/W Bearing</b> 23.S115072 '06-23 2x	<b>Rear Pad Set</b> 37.208502 '06-23 37.208502BX '06-23 Box of 10			<b>Lower A-Arm</b> 26.510038 '06-18
---	--	--	---	---	--	--	---

<b>Water Pump Rebuild Kit</b> 57.1623 '06-23			<b>R/W Bearing</b> 23.S114080 '06-23 2x	<b>Front Master Cylinder Rebuild Kit</b> 37.910013 '06-23			<b>Upper A-Arm</b> 26.510003 '15-18
--	--	--	---	---	--	--	---

<b>Air Filter</b> 52.17008 '08-11	<b>Spring Kit</b> 17.CS13006 '08-11	<b>Friction Set</b> 16.S14022 '08-11	<b>F/W Bearing</b> 23.S115076 '08-11 2x	<b>Frontbrake Disc</b> 37.BD11404 '08-09 2x	<b>Front Sprocket</b> 07.FS13088-12 07.FS13088-13 07.FS13088-14 07.FS13088-15 '08-11	<b>Upper</b> 26.450019 '08-11	
---	---	--	---	---	---	-------------------------------------	--

			<b>R/W Bearing</b> 23.S116024 '08-11 2x	<b>Front Pad Set</b> 37.103202 '08-11 2x 37.103202BX '08-11 Box of 10	<b>Chain</b> 07.RC520120C '08-11 MX 07.RC520120CG '08-11 MX Gold 07.RC520120XC '08-11 X-Ring 07.RC520120XCG '08-11 X-Ring Gold		
--	--	--	---	---	--	--	--

				<b>Front Master Cylinder Rebuild Kit</b> 37.910011 '08-11			
--	--	--	--	---	--	--	--

<b>Air Filter</b> 52.15005 '09-13				<b>Rear Master Cylinder Rebuild Kit</b> 37.910007 '08-11			
---	--	--	--	--	--	--	--

				<b>Front Caliper Rebuild Kit</b> 37.63017 '08-11			
--	--	--	--	--	--	--	--

				<b>Rear Caliper Rebuild Kit</b> 37.63052 '08-11			
--	--	--	--	---	--	--	--

**DIRT**  
APRILIA  
BETA  
BMW  
GAS GAS  
HONDA  
HUSABERG  
HUSQVARNA  
KAWASAKI  
KTM  
MOTO TM  
RIEJU  
SHERCO  
SUZUKI  
YAMAHA

**STREET**  
APRILIA  
CAGIVA  
HONDA  
KAWASAKI  
KTM  
SUZUKI  
YAMAHA

**ATV-UTV**  
CAN-AM  
GAS GAS  
HONDA  
KAWASAKI  
KTM  
KYMCO  
PGO  
POLARIS  
SUZUKI  
YAMAHA

**PWC**  
KAWASAKI  
POLARIS  
SEA DOO  
YAMAHA

**SNOW**  
ARCTIC CAT  
KAWASAKI  
LYNX  
MOTO-SKI  
POLARIS  
SKI DOO  
YAMAHA

**MOPED & SCOOTER**

**MISC. TECH. SPECIAL**



### KAWASAKI

**DIRT**  
APRILIA  
BETA  
BMW  
GAS GAS  
HONDA  
HUSABERG  
HUSQVARNA  
KAWASAKI  
KTM  
MOTO TM  
RIEJU  
SHERCO  
SUZUKI  
YAMAHA

**STREET**  
APRILIA  
CAGIVA  
HONDA  
KAWASAKI  
KTM  
SUZUKI  
YAMAHA

**ATV-UTV**  
CAN-AM  
GAS GAS  
HONDA  
KAWASAKI  
KTM  
KYMCO  
PGO  
POLARIS  
SUZUKI  
YAMAHA

**PWC**  
KAWASAKI  
POLARIS  
SEA DOO  
YAMAHA

**SNOW**  
ARCTIC CAT  
KAWASAKI  
LYNX  
MOTO-SKI  
POLARIS  
SKI DOO  
YAMAHA

**MOPED & SCOOTER**

**MISC. TECH. SPECIAL**

<b>KFX 50</b> 2-Stroke	<b>Piston kit</b> 01.3001.000 01.3001.050 01.3001.100 01.3001.150 01.3001.200 '03-06	<b>Size</b> 41.00 41.50 42.00 42.50 43.00	<b>Ring Set</b> - - 02.3001.100 02.3001.150 - '03-06  <b>Clips</b> 05.1210C '03-06	<b>Bearing</b> 23.6203C3 '03-06	<b>S/E Bearing</b> 21.3001 '03-06	<b>Top-End</b> 35.3001 '03-06			
<b>KFX 80</b> 2-Stroke	<b>Piston kit</b> 01.3180.000 01.3180.050 01.3180.100 01.3180.150 '03-06	<b>Size</b> 50.00 50.50 51.00 51.50	<b>Ring Set</b> 02.3180.000 02.3180.050 02.3180.100 02.3180.150 '03-06  <b>Clips</b> 05.1210C '03-06	<b>Bearing</b> 23.6204C3 '03-06 2x	<b>S/E Bearing</b> 21.3001 '03-06	<b>Complete</b> 34.3180 '03-06  <b>Top-End</b> 35.3180 '03-06			
<b>KXF 250 Tecate</b> 2-Stroke Please Note: Nikasil Piston Size	<b>Piston kit</b> -	<b>Size</b> 67.40	<b>Ring Set</b> -	<b>Crank Bearing &amp; Seal Kit</b> 23.CBS43187 '87-88  <b>Bearing</b> 23.6328C3 '87-88 2x  <b>Oilseal Set</b> 42.4607 '87-88	<b>Con. Rod Kit</b> 03.4309 '87-88  <b>S/E Bearing</b> 21.4305 '87-88  <b>B/E Bearing</b> 22.243220F '87-88  <b>Crankpin</b> 06.2458.5 '87-88				
<b>KVF 360 Prairie</b> 4-Stroke -Std. Compression 8.3:1	<b>Piston kit</b> -	<b>Size</b> 80.00	<b>Ring Set</b> -			<b>Top-End</b> 35.4303 '03-13	<b>Cam Chain</b> 31.1655 '03-12		

Footnotes: \* Bearings Only

									<b>Chain</b> 07.RC430130C '03-06 MX				
									<b>Chain</b> 07.RC520120C '03-06 MX 07.RC520120CG '03-06 MX Gold 07.RC520120XC '03-06 X-Ring 07.RC520120XCG '03-06 X-Ring Gold				
								<b>Rear Pad Set</b> 37.200802 '87-88 37.200802BX '87-88 Box of 10	<b>Front Sprocket</b> 07.FS23080-13 07.FS23080-14 07.FS23080-15 '87-88  <b>Chain</b> 07.RC520120C '87-88 MX 07.RC520120CG '87-88 MX Gold 07.RC520120XC '87-88 X-Ring 07.RC520120XCG '87-88 X-Ring Gold  <b>Lower Chain Roller</b> 33.0001 '87-88  <b>Upper Chain Roller</b> 33.0001 '87-88	<b>Swingarm</b> 26.210080 '87-88		<b>Rear Shock Seal Head Kit</b> 26.810010 '87-88	
								<b>F/W Bearing</b> 23.S114097 '03-13 2x	<b>Front Pad Set</b> 37.202002 '03-13 Left 37.202002 '03-13 Right 37.202002BX '03-13 Box of 10  <b>Front Master Cylinder Rebuild Kit</b> 37.910012 '03-13  <b>Front Caliper Rebuild Kit</b> 37.63022 '03-13		<b>Swingarm</b> 26.210059 '03-13		

**DIRT**  
APRILIA  
BETA  
BMW  
GAS GAS  
HONDA  
HUSABERG  
HUSQVARNA  
KAWASAKI  
KTM  
MOTO TM  
RIEJU  
SHERCO  
SUZUKI  
YAMAHA

**STREET**  
APRILIA  
CAGIVA  
HONDA  
KAWASAKI  
KTM  
SUZUKI  
YAMAHA

**ATV-UTV**  
CAN-AM  
GAS GAS  
HONDA  
KAWASAKI  
KTM  
KYMCO  
PGO  
POLARIS  
SUZUKI  
YAMAHA

**PWC**  
KAWASAKI  
POLARIS  
SEA DOO  
YAMAHA

**SNOW**  
ARCTIC CAT  
KAWASAKI  
LYNX  
MOTO-SKI  
POLARIS  
SKI DOO  
YAMAHA

**MOPED & SCOOTER**

**MISC. TECH. SPECIAL**





### KAWASAKI

**DIRT**  
APRILIA  
BETA  
BMW  
GAS GAS  
HONDA  
HUSABERG  
HUSQVARNA  
KAWASAKI  
KTM  
MOTO TM  
RIEJU  
SHERCO  
SUZUKI  
YAMAHA

**STREET**  
APRILIA  
CAGIVA  
HONDA  
KAWASAKI  
KTM  
SUZUKI  
YAMAHA

**ATV-UTV**  
CAN-AM  
GAS GAS  
HONDA  
KAWASAKI  
KTM  
KYMCO  
PGO  
POLARIS  
SUZUKI  
YAMAHA

**PWC**  
KAWASAKI  
POLARIS  
SEA DOO  
YAMAHA

**SNOW**  
ARCTIC CAT  
KAWASAKI  
LYNX  
MOTO-SKI  
POLARIS  
SKI DOO  
YAMAHA

**MOPED & SCOOTER**

**MISC. TECH. SPECIAL**

<b>KFX 400</b> 4-Stroke Please Note: Nikasil Piston Size -Forged Piston	<b>Piston Kit</b> 01.3420.A 01.3420.B 01.3420.C '03-06	<b>Size (mm)</b> 89.96 89.97 89.98	<b>Ring Set</b> 02.3402 02.3402 02.3402 '03-06  <b>Clips</b> 05.2012 '03-06	<b>Crank Bearing &amp; Seal Kit</b> 23.CBS34000* '03-06  <b>Bearing</b> 23.6306R/3 '03-06 2x	<b>Con. Rod Kit</b> 03.3402 '03-06  <b>B/E Bearing</b> 22.354322F '03-06	<b>Complete</b> 34.3423 '03-06  <b>Top-End</b> 35.3423 '03-06	<b>Cam Chain</b> 31.3403 '03-06  <b>Valve Shim Assortment</b> 29.VSA948 '03-06 29.VSA948-2 '03-06	<b>Valve</b> 28.3402-1 '03-06 2x Exhaust Steel 28.3402-2 '03-06 2x Intake Steel
<b>KFX 450 R</b> 4-Stroke Please Note: Nikasil Piston Size -Std. Compression 12.5:1 -Forged Piston -Fuel Injection	<b>Piston Kit</b> 01.4418.A 01.4418.B 01.4418.C '08-14	<b>Size</b> 95.95 95.96 95.97	<b>Ring Set</b> 02.1496 02.1496 02.1496 '08-14  <b>Clips</b> 05.2112 '08-14		<b>B/E Bearing</b> 22.344220F '08-14	<b>Complete</b> 34.4408 '08-14  <b>Top-End</b> 35.4408 '08-14	<b>Cam Chain</b> 31.2706 '08-14  <b>Valve Shim Assortment</b> 29.VSA948 '08-14 29.VSA948-2 '08-14	<b>Valve</b> 28.4406-1 '08-14 2x Exhaust Titanium  <b>TI-Steel Conversion Set</b> 28.SES4406-1 '08-14 Exhaust  <b>Valve Seal</b> 35.VS022 '08-14 4x
	<b>High Compression</b> 01.4419.A 01.4419.B '08-14	<b>Size</b> 95.95 95.96	<b>Ring Set</b> 02.1496 02.1496 '08-14					

Footnotes: \* Bearings Only

<b>Air Filter</b> 52.44003 '03-06	<b>Basket</b> 17.3400F '03-06	<b>Friction Set</b> 16.S34015 '03-04	<b>F/W Bearing</b> 23.S110042 '03-06 2x	<b>Front Pad Set</b> 37.200802 '03-06 37.200802BX '03-06 Box of 10	<b>Front Sprocket</b> 07.FS34003-14 07.FS34003-15 '03-06  <b>Chain</b> 07.RC520120C '03-06 MX 07.RC520120CG '03-06 MX Gold 07.RC520120XC '03-06 X-Ring 07.RC520120XCG '03-06 X-Ring Gold	<b>Swingarm</b> 26.210094 '03-06  <b>Linkage</b> 26.110093 '03-06  <b>Lower</b> 26.450025 '03-06		<b>Rear Shock Seal Head Kit</b> 26.810006 '03-06
<b>Main Jet</b> 47.221110-170 '03-06 Mikuni	<b>Spring Kit</b> 17.CS44019 '03-06	<b>Friction Set</b> 16.S34020 '05	<b>R/W Bearing</b> 23.S113031 '03-06	<b>Rear Pad Set</b> 37.207402 '03-06 37.207402BX '03-06 Box of 10				
<b>Pilot Jet</b> 49.010-045 '03-06 Mikuni	<b>Cover Gasket</b> 19.G3403 '03-06			<b>Front Caliper Rebuild Kit</b> 37.63023 '03-06	<b>Lower Chain Roller</b> 33.0001 '03-06			
<b>Throttle Cable</b> 53.110098 '03-06	<b>Clutch Cable</b> 53.120067 '03-06			<b>Rear Caliper Rebuild Kit</b> 37.63038 '03-06				
<b>Oil Filter</b> 54.34139 '03-06 1-Pce. 54.34139-50 '03-06 50-Pcs.				<b>Front Master Cylinder Rebuild Kit</b> 37.910004 '03-06				
<b>Water Pump Rebuild Kit</b> 57.3422 '03-06				<b>Rear Master Cylinder Rebuild Kit</b> 37.910003 '03-06				
<b>Air Filter</b> 52.44009 '08-14	<b>Inner Hub</b> 18.4406 '08-14	<b>Complete Plate Set</b> 16.CPS44008 '08-14	<b>F/W Bearing</b> 23.S110035 '08-14 2x	<b>Front Pad Set</b> 37.209402 '08-14 Left 37.209402BX '08-14 Box of 10 37.106202 '08-14 Right 37.106202BX '08-14 Box of 10	<b>Front Sprocket</b> 07.FS44008-14 07.FS44008-15 '08-14  <b>Chain</b> 07.RC520120C '08-14 MX 07.RC520120CG '08-14 MX Gold 07.RC520120XC '08-14 X-Ring 07.RC520120XCG '08-14 X-Ring Gold	<b>Swingarm</b> 26.210186 '08-14  <b>Linkage</b> 26.110160 '08-14  <b>Lower</b> 26.450022 '08-14		<b>Rear Shock Seal Head Kit</b> 26.810002 '08-14
<b>Oil Filter</b> 54.44113 '08-14 1-Pce. 54.44113-50 '08-14 50-Pcs.	<b>Pressure Plate</b> 18.P4406 '08-14	<b>Friction Set</b> 16.S44039 '08-14	<b>R/W Bearing</b> 23.S115060 '08-14	<b>Rear Pad Set</b> 37.200802 '08-14 37.200802BX '08-14 Box of 10				
	<b>Spring Kit</b> 17.CS44020 '08-14	<b>Steel Set</b> 16.S34016 '08-14		<b>Front Caliper Rebuild Kit</b> 37.63021 '08-14				
	<b>Cover Gasket</b> 19.G4406 '08-14			<b>Rear Caliper Rebuild Kit</b> 37.63038 '08-14				
				<b>Front Master Cylinder Rebuild Kit</b> 37.910004 '08-14				
				<b>Rear Master Cylinder Rebuild Kit</b> 37.910007 '08-14				

**DIRT**  
APRILIA  
BETA  
BMW  
GAS GAS  
HONDA  
HUSABERG  
HUSQVARNA  
KAWASAKI  
KTM  
MOTO TM  
RIEJU  
SHERCO  
SUZUKI  
YAMAHA

**STREET**  
APRILIA  
CAGIVA  
HONDA  
KAWASAKI  
KTM  
SUZUKI  
YAMAHA

**ATV-UTV**  
CAN-AM  
GAS GAS  
HONDA  
KAWASAKI  
KTM  
KYMCO  
PGO  
POLARIS  
SUZUKI  
YAMAHA

**PWC**  
KAWASAKI  
POLARIS  
SEA DOO  
YAMAHA

**SNOW**  
ARCTIC CAT  
KAWASAKI  
LYNX  
MOTO-SKI  
POLARIS  
SKI DOO  
YAMAHA

**MOPED & SCOOTER**

**MISC. TECH. SPECIAL**



### KAWASAKI

**DIRT**  
 APRILIA  
 BETA  
 BMW  
 GAS GAS  
 HONDA  
 HUSABERG  
 HUSQVARNA  
 KAWASAKI  
 KTM  
 MOTO TM  
 RIEJU  
 SHERCO  
 SUZUKI  
 YAMAHA

**STREET**  
 APRILIA  
 CAGIVA  
 HONDA  
 KAWASAKI  
 KTM  
 SUZUKI  
 YAMAHA

**ATV-UTV**  
 CAN-AM  
 GAS GAS  
 HONDA  
 KAWASAKI  
 KTM  
 KYMCO  
 PGO  
 POLARIS  
 SUZUKI  
 YAMAHA

**PWC**  
 KAWASAKI  
 POLARIS  
 SEA DOO  
 YAMAHA

**SNOW**  
 ARCTIC CAT  
 KAWASAKI  
 LYNX  
 MOTO-SKI  
 POLARIS  
 SKI DOO  
 YAMAHA

**MOPED & SCOOTER**

**MISC. TECH. SPECIAL**

	Piston kit	Size (mm)	Ring Set			Complete	Cam Chain	Valve Seal
<b>KFX 700</b> 4-Stroke -Std. Compression 9.9:1	-	82.00	-			34.4704 '04-09  <b>Top-End</b> 35.4704 '04-09	31.4705 '06-09 46L 1x 31.4706 '06-09 92L 2x	35.VS024 '04-09 8x
<b>KVF 700 Prairie</b> 4-Stroke -Std. Compression 9.9:1	-	82.00	-			34.4704 '04-06  <b>Top-End</b> 35.4704 '04-06		35.VS024 '04-06 8x
<b>KVF 750 Brute Force</b> 4-Stroke -Std. Compression 8.8:1	Piston kit 01.4705.A 01.4705.B 01.4705.C '05-11	Size 84.96 84.97 84.98	Ring Set 02.4705 02.4705 02.4705 '05-11			<b>Top-End</b> 35.4705 '05-16	Cam Chain 31.4705 '05-23 46L 1x 31.4706 '05-23 92L 2x	Valve Seal 35.VS024 '05-16 8x

Footnotes: \* Bearings Only

<b>Water Pump Rebuild Kit</b> 57.4625 '04-09								
<b>Water Pump Rebuild Kit</b> 57.4625 '04-06								
<b>Water Pump Rebuild Kit</b> 57.4625 '05-15								
<b>F/W Bearing</b> 23.S110035 '04-09 2x								
<b>F/W Bearing</b> 23.S114097 '04-06 2x								
<b>F/W Bearing</b> 23.S114097 '05-17 2x								
<b>R/W Bearing</b> 23.S115036 '05-17 2x								
<b>Front Pad Set</b> 37.209402 '04-09 Left 37.209402BX '04-09 Box of 10 37.106202 '04-09 Right 37.106202BX '04-09 Box of 10								
<b>Front Pad Set</b> 37.209402 '04-06 Left 37.209402BX '04-06 Box of 10 37.106202 '04-06 Right 37.106202BX '04-06 Box of 10								
<b>Front Pad Set</b> 37.204302 '05-14 Left 37.204302BX '05-14 Box of 10 37.100202 '05-14 Right 37.100202BX '05-14 Box of 10								
<b>Front Master Cylinder Rebuild Kit</b> 37.910012 '04-09								
<b>Front Master Cylinder Rebuild Kit</b> 37.910012 '04-06								
<b>Front Master Cylinder Rebuild Kit</b> 37.910015 '05-17								
<b>Front Caliper Rebuild Kit</b> 37.63025 '04-09								
<b>Front Caliper Rebuild Kit</b> 37.63025 '04-06								
<b>Front Caliper Rebuild Kit</b> 37.63009 '05-17								
<b>Swingarm</b> 26.210059 '04-09								
<b>Swingarm</b> 26.210059 '04-06								
<b>Upper A-Arm</b> 26.510032 '05-11								

**DIRT**  
 APRILIA  
 BETA  
 BMW  
 GAS GAS  
 HONDA  
 HUSABERG  
 HUSQVARNA  
 KAWASAKI  
 KTM  
 MOTO TM  
 RIEJU  
 SHERCO  
 SUZUKI  
 YAMAHA

**STREET**  
 APRILIA  
 CAGIVA  
 HONDA  
 KAWASAKI  
 KTM  
 SUZUKI  
 YAMAHA

**ATV-UTV**  
 CAN-AM  
 GAS GAS  
 HONDA  
 KAWASAKI  
 KTM  
 KYMCO  
 PGO  
 POLARIS  
 SUZUKI  
 YAMAHA

**PWC**  
 KAWASAKI  
 POLARIS  
 SEA DOO  
 YAMAHA

**SNOW**  
 ARCTIC CAT  
 KAWASAKI  
 LYNX  
 MOTO-SKI  
 POLARIS  
 SKI DOO  
 YAMAHA

**MOPED & SCOOTER**

**MISC. TECH. SPECIAL**



### KTM

**DIRT**  
APRILIA  
BETA  
BMW  
GAS GAS  
HONDA  
HUSABERG  
HUSQVARNA  
KAWASAKI  
KTM  
MOTO TM  
RIEJU  
SHERCO  
SUZUKI  
YAMAHA

<b>KTM 450 XC ATV</b> 4-Stroke Please Note: Nikasil Piston Size -Std. Compression 11.0:1	<b>Piston kit</b> 01.6413.A 01.6413.B 01.6413.C '08-09	<b>Size</b> 88.95 88.96 88.97	<b>Ring Set</b> 02.6413 02.6413 02.6413 '08-09	<b>Crank Bearing &amp; Seal Kit</b> 23.CBS64003 '08-09	<b>Con. Rod Kit</b> 03.6520 '08-09	<b>Complete</b> 34.6428 '08-09		<b>Valve</b> 28.6520-1 '08-09 2x Exhaust Steel 28.6520-2 '08-09 2x Intake Steel  <b>Valve Seal</b> 35.VS026 '08-09 4x
			<b>Pin</b> 04.2055.5 '08-09	<b>Bearing</b> 23.NJ206 '08-09	<b>B/E Bearing</b> 22.354322F '08-09	<b>Top-End</b> 35.6428 '08-09		
			<b>Clips</b> 05.2012 '08-09	<b>Oilseal</b> 41.6-304772 '08-09 1x	<b>Crankpin</b> 06.3564.7 '08-09			

**STREET**  
APRILIA  
CAGIVA  
HONDA  
KAWASAKI  
KTM  
SUZUKI  
YAMAHA

<b>KTM 450 SX ATV</b> 4-Stroke Please Note: Nikasil Piston Size -Std. Compression 12.5:1 -Forged Piston	<b>Piston kit</b> 01.6427.A 01.6427.B 01.6427.C '09-10	<b>Size</b> 96.94 96.95 96.96	<b>Ring Set</b> 02.6427 02.6427 02.6427 '09-10	<b>Crank Bearing &amp; Seal Kit</b> 23.CBS64007 '09-10	<b>Con. Rod Kit</b> 03.6427 '09-10	<b>Complete</b> 34.6429 '09-10	<b>Cam Chain</b> 31.6427 '09-10	<b>Valve</b> 28.6427-1 '09-10 2x Exhaust Titanium 28.6427-2 '09-10 2x Intake Titanium
				<b>Bearing</b> 23.NJ206ECP-2 '09-10 2x	<b>B/E Bearing</b> 22.354220F '09-10	<b>Top-End</b> 35.6429 '09-10	<b>Valve Shim Assortment</b> 29.VSA890 '09-10	<b>Valve Seal</b> 35.VS026 '09-10 4x
	<b>High Compression</b> 01.6428.A '09-10	<b>Size</b> 96.94	<b>Ring Set</b> 02.6427 '09-10	<b>Oilseal Set</b> 42.6427 '09-10	<b>Crankpin</b> 06.3563.9 '09-10			

**ATV-UTV**  
CAN-AM  
GAS GAS  
HONDA  
KAWASAKI  
KTM  
KYMCO  
PGO  
POLARIS  
SUZUKI  
YAMAHA

Please Note: Nikasil Piston Size -High Compression 13.5:1 -Forged Piston	<b>High Compression</b> 01.6428.A '09-10	<b>Size</b> 96.94	<b>Ring Set</b> 02.6427 '09-10					
			<b>Pin</b> 04.1947.5 '09-10					
			<b>Clips</b> 05.1912 '09-10					

**PWC**  
KAWASAKI  
POLARIS  
SEA DOO  
YAMAHA

<b>KTM 505 SX ATV</b> 4-Stroke Please Note: Nikasil Piston Size -Std. Compression 12.5:1 -Forged Piston	<b>Piston kit</b> 01.6508.A 01.6508.B 01.6508.C '09-10	<b>Size</b> 99.94 99.95 99.96	<b>Ring Set</b> 02.6508 02.6508 02.6508 '09-10	<b>Crank Bearing &amp; Seal Kit</b> 23.CBS64007 '09-10	<b>Con. Rod Kit</b> 03.6508 '09-12	<b>Complete</b> 34.6508 '09-10	<b>Cam Chain</b> 31.6427 '09-12	<b>Valve</b> 28.6427-1 '09-12 2x Exhaust Titanium 28.6427-2 '09-12 2x Intake Titanium
				<b>Bearing</b> 23.NJ206ECP-2 '09-10 2x	<b>B/E Bearing</b> 22.354220F '09-12	<b>Top-End</b> 35.6508 '09-10	<b>Valve Shim Assortment</b> 29.VSA890 '09-12	<b>Valve Seal</b> 35.VS026 '09-12 4x
	<b>High Compression</b> 01.6509.A 01.6509.B '09-10	<b>Size</b> 99.94 99.95	<b>Ring Set</b> 02.6508 02.6508 '09-10	<b>Oilseal Set</b> 42.6427 '09-12	<b>Crankpin</b> 06.3563.9 '09-12			

**SNOW**  
ARCTIC CAT  
KAWASAKI  
LYNX  
MOTO-SKI  
POLARIS  
SKI DOO  
YAMAHA

Please Note: Nikasil Piston Size -High Compression 13.5:1 -Forged Piston	<b>High Compression</b> 01.6509.A 01.6509.B '09-10	<b>Size</b> 99.94 99.95	<b>Ring Set</b> 02.6508 02.6508 '09-10					
			<b>Pin</b> 04.2045 '09-10					
			<b>Clips</b> 05.2012 '09-10					

**MOPED & SCOOTER**

**MISC. TECH. SPECIAL**

Footnotes: \* Bearings Only

<b>Air Filter</b> 52.62007 '08-09	<b>Spring Kit</b> 17.CS65041 '08-09	<b>Complete Plate Set</b> 16.CPS64006 '08-09	<b>F/W Bearing</b> 23.S115064 '08-09 2x	<b>Front Pad Set</b> 37.217102 '08-09 37.217102BX '08-09 Box of 10	<b>Front Sprocket</b> 07.FS62093-12 07.FS62093-13 07.FS62093-14 07.FS62093-15 '08-09	<b>Swingarm</b> 26.210168 '08-09		
<b>Main Jet</b> 45.100-225 '08-09 Keihin	<b>Cover Gasket</b> 19.G6520 '08-09	<b>Friction Set</b> 16.S54007 '08-09	<b>R/W Bearing</b> 23.S115007 '08-09	<b>Rear Pad Set</b> 37.227102 '08-09 37.227102BX '08-09 Box of 10	<b>Chain</b> 07.RC520120C '08-09 MX 07.RC520120CG '08-09 MX Gold 07.RC520120XC '08-09 X-Ring 07.RC520120XCG '08-09 X-Ring			
<b>Pilot Jet</b> 46.040-085 '08-09 Keihin		<b>Steel Set</b> 16.S54010 '08-09						
<b>Oil Filter #1</b> 54.63655 '08-09 1-Pce. 54.63655-50 '08-09 50-Pcs.								
<b>Oil Filter #2</b> 54.64157 '08-09 1-Pce. 54.64157-50 '08-09 50-Pcs.								

<b>Air Filter</b> 52.62007 '08-09 52.62010 '10	<b>Spring Kit</b> 17.CS64042 '09-10	<b>Complete Plate Set</b> 16.CPS64007 '09-10	<b>F/W Bearing</b> 23.S115064 '09-10 2x	<b>Front Pad Set</b> 37.217102 '09-10 37.217102BX '09-10 Box of 10	<b>Front Sprocket</b> 07.FS62093-12 07.FS62093-13 07.FS62093-14 07.FS62093-15 '09-10	<b>Swingarm</b> 26.210168 '09-10		<b>Rear Shock Seal Head Kit</b> 26.810120 '10
<b>Main Jet</b> 45.100-225 '09-10 Keihin	<b>Cover Gasket</b> 19.G6427 '09-10	<b>Friction Set</b> 16.S54015 '09-10	<b>R/W Bearing</b> 23.S115007 '09-10	<b>Rear Pad Set</b> 37.227102 '09-10 37.227102BX '09-10 Box of 10	<b>Chain</b> 07.RC520120C '09-10 MX 07.RC520120CG '09-10 MX Gold 07.RC520120XC '09-10 X-Ring 07.RC520120XCG '09-10 X-Ring Gold	<b>Lower</b> 26.350059 '09-10		
<b>Pilot Jet</b> 46.040-085 '09-10 Keihin	<b>Master Cyl. Rebuild Kit</b> 16.940005 '09-10	<b>Steel Set</b> 16.S54006 '09-10				<b>Upper</b> 26.350059 '09-10		
<b>Carburetor Rebuild Kit</b> 55.10520 '09-10								

<b>Air Filter</b> 52.62007 '09 52.62010 '10	<b>Spring Kit</b> 17.CS64042 '09-12	<b>Complete Plate Set</b> 16.CPS64007 '09-12	<b>F/W Bearing</b> 23.S115064 '09-12 2x	<b>Front Pad Set</b> 37.217102 '09-12 37.217102BX '09-12 Box of 10	<b>Front Sprocket</b> 07.FS62093-12 07.FS62093-13 07.FS62093-14 07.FS62093-15 '09-12	<b>Swingarm</b> 26.210168 '09-12		<b>Rear Shock Seal Head Kit</b> 26.810120 '10-12
<b>Main Jet</b> 45.100-225 '09-12 Keihin	<b>Cover Gasket</b> 19.G6427 '09-10	<b>Friction Set</b> 16.S54015 '09-12	<b>R/W Bearing</b> 23.S115007 '09-12	<b>Rear Pad Set</b> 37.227102 '09-10 37.227102BX '09-10 Box of 10	<b>Chain</b> 07.RC520120C '09-10 MX 07.RC520120CG '09-10 MX Gold 07.RC520120XC '09-10 X-Ring 07.RC520120XCG '09-10 X-Ring Gold	<b>Lower</b> 26.350059 '09-12		
<b>Pilot Jet</b> 46.040-085 '09-12 Keihin		<b>Steel Set</b> 16.S54006 '09-12				<b>Upper</b> 26.350059 '09-12		
<b>Carburetor Rebuild Kit</b> 55.10520 '09-10								

**DIRT**  
APRILIA  
BETA  
BMW  
GAS GAS  
HONDA  
HUSABERG  
HUSQVARNA  
KAWASAKI  
KTM  
MOTO TM  
RIEJU  
SHERCO  
SUZUKI  
YAMAHA

**STREET**  
APRILIA  
CAGIVA  
HONDA  
KAWASAKI  
KTM  
SUZUKI  
YAMAHA

**ATV-UTV**  
CAN-AM  
GAS GAS  
HONDA  
KAWASAKI  
KTM  
KYMCO  
PGO  
POLARIS  
SUZUKI  
YAMAHA

**PWC**  
KAWASAKI  
POLARIS  
SEA DOO  
YAMAHA

**SNOW**  
ARCTIC CAT  
KAWASAKI  
LYNX  
MOTO-SKI  
POLARIS  
SKI DOO  
YAMAHA

**MOPED & SCOOTER**

**MISC. TECH. SPECIAL**





### KAWASAKI

**DIRT**  
APRILIA  
BETA  
BMW  
GAS GAS  
HONDA  
HUSABERG  
HUSQVARNA  
KAWASAKI  
KTM  
MOTO TM  
RIEJU  
SHERCO  
SUZUKI  
YAMAHA

<b>KTM 525 XC ATV</b> 4-Stroke Please Note: Nikasil Piston Size -Std. Compression 11.0:1 -Forged Piston	<b>Piston kit</b> 01.6521.A 01.6521.B 01.6521.C '08-12	<b>Size</b> 94.94 94.95 94.96	<b>Ring Set</b> 02.6424 02.6424 02.6424 '08-12	<b>Crank Bearing &amp; Seal Kit</b> 23.CBS64003 '08-12	<b>Con. Rod Kit</b> 03.6520 '08-12	<b>Complete</b> 34.6528 '08-11	<b>Valve</b> 28.6520-1 '08-12 2x Exhaust Steel 28.6520-2 '08-12 2x Intake Steel	<b>Valve Seal</b> 35.VS026 '08-12 4x
			<b>Pin</b> 04.2050.5 '08-12	<b>Bearing</b> 23.NJ206 '08-12	<b>B/E Bearing</b> 22.354322F '08-12	<b>Top-End</b> 35.6528 '08-11		
			<b>Clips</b> 05.2012 '08-12	<b>Oilseal</b> 41.6-304772 '08-12 1x	<b>Crankpin</b> 06.3564.7 '08-12			

### POLARIS

**STREET**  
APRILIA  
CAGIVA  
HONDA  
KAWASAKI  
KTM  
SUZUKI  
YAMAHA

<b>Trail Blazer 250</b> 2-Stroke	<b>Piston kit</b> -	<b>Size</b> 72.00	<b>Ring Set</b> -			<b>Top-End</b> 35.5385 '90-06		
-------------------------------------	------------------------	----------------------	----------------------	--	--	-------------------------------------	--	--

**PWC**  
KAWASAKI  
POLARIS  
SEA DOO  
YAMAHA

<b>Trail Boss 250</b> 2-Stroke	<b>Piston kit</b> -	<b>Size</b> 72.00	<b>Ring Set</b> -			<b>Top-End</b> 35.5385 '85-99		
-----------------------------------	------------------------	----------------------	----------------------	--	--	-------------------------------------	--	--

**SNOW**  
ARCTIC CAT  
KAWASAKI  
LYNX  
MOTO-SKI  
POLARIS  
SKI DOO  
YAMAHA

<b>Trail Boss 250 4x4</b> 2-Stroke	<b>Piston kit</b> -	<b>Size</b> 72.00	<b>Ring Set</b> -			<b>Top-End</b> 35.5385 '87-93		
---------------------------------------	------------------------	----------------------	----------------------	--	--	-------------------------------------	--	--

Footnotes: \* Bearings Only

<b>Air Filter</b> 52.62007 '08-09 52.62010 '10-12	<b>Spring Kit</b> 17.CS65041 '08-12	<b>Complete Plate Set</b> 16.CPS64006 '08-12	<b>F/W Bearing</b> 23.S115064 '08-12 2x	<b>Front Pad Set</b> 37.217102 '08-12 37.217102BX '08-12 Box of 10	<b>Front Sprocket</b> 07.FS62093-12 07.FS62093-13 07.FS62093-14 07.FS62093-15 '08-12	<b>Swingarm</b> 26.210168 '08-12		
<b>Main Jet</b> 45.100-225 '08-12 Keihin	<b>Cover Gasket</b> 19.G6520 '08-12	<b>Friction Set</b> 16.S54007 '08-12	<b>R/W Bearing</b> 23.S115007 '08-12	<b>Rear Pad Set</b> 37.227102 '08-11 37.227102BX '08-11 Box of 10	<b>Chain</b> 07.RC520120C '08-12 MX 07.RC520120CG '08-12 MX Gold 07.RC520120XC '08-12 X-Ring 07.RC520120XCG '08-12 X-Ring Gold			
<b>Pilot Jet</b> 46.040-085 '08-12 Keihin		<b>Steel Set</b> 16.S54010 '08-12						
<b>Oil Filter #1</b> 54.63655 '08-12 1-Pce. 54.63655-50 '08-12 50-Pcs.								
<b>Oil Filter #2</b> 54.64157 '08-12 1-Pce. 54.64157-50 '08-12 50-Pcs.								
<b>Water Pump Rebuild Kit</b> 57.6322 '08-09								

**DIRT**  
APRILIA  
BETA  
BMW  
GAS GAS  
HONDA  
HUSABERG  
HUSQVARNA  
KAWASAKI  
KTM  
MOTO TM  
RIEJU  
SHERCO  
SUZUKI  
YAMAHA

**STREET**  
APRILIA  
CAGIVA  
HONDA  
KAWASAKI  
KTM  
SUZUKI  
YAMAHA

**ATV-UTV**  
CAN-AM  
GAS GAS  
HONDA  
KAWASAKI  
KTM  
POLARIS  
SUZUKI  
YAMAHA

			<b>F/W Bearing</b> 23.S111029 '90-04 2x 23.S115000 '05-06 2x	<b>Front Pad Set</b> 37.206402 '90-06 Left 37.206402 '90-06 Right 37.206402BX '90-06 Box of 10	<b>Chain</b> 07.RC520120C '90-06 MX 07.RC520120CG '90-06 MX Gold 07.RC520120XC '90-06 X-Ring 07.RC520120XCG '90-06 X-Ring Gold	<b>Lower A-Arm</b> 26.510048 '90-02 26.510049 '03-06		
			<b>R/W Bearing</b> 23.S113021 '90-98 23.S111051 '99-06	<b>Rear Pad Set</b> 37.204402 '90-98 37.204402BX '90-98 Box of 10				

**PWC**  
KAWASAKI  
POLARIS  
SEA DOO  
YAMAHA

			<b>F/W Bearing</b> 23.S110098 '85-87 2x 23.S111029 '88-99 2x	<b>Front Pad Set</b> 37.206402 '85-99 Left 37.206402 '85-99 Right 37.206402BX '85-99 Box of 10	<b>Chain</b> 07.RC520120C '85-99 MX 07.RC520120CG '85-99 MX Gold 07.RC520120XC '85-99 X-Ring 07.RC520120XCG '85-99 X-Ring Gold	<b>Lower A-Arm</b> 26.510049 '88-92 26.510048 '93-99		
			<b>R/W Bearing</b> 23.S113021 '85-99	<b>Rear Pad Set</b> 37.204402 '85-99 37.204402BX '85-99 Box of 10				

**SNOW**  
ARCTIC CAT  
KAWASAKI  
LYNX  
MOTO-SKI  
POLARIS  
SKI DOO  
YAMAHA

			<b>F/W Bearing</b> 23.S110008 '87-93 2x	<b>Front Pad Set</b> 37.206402 '87-93 Left 37.206402 '87-93 Right 37.206402BX '87-93 Box of 10	<b>Chain</b> 07.RC520120C '87-93 MX 07.RC520120CG '87-93 MX Gold 07.RC520120XC '87-93 X-Ring 07.RC520120XCG '87-93 X-Ring Gold	<b>Lower A-Arm</b> 26.510049 '87-92 26.510048 '93		
			<b>R/W Bearing</b> 23.S113021 '87-93	<b>Rear Pad Set</b> 37.204402 '87-93 37.204402BX '87-93 Box of 10				

**MOPED & SCOOTER**

**MISC. TECH. SPECIAL**



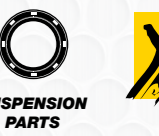
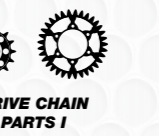
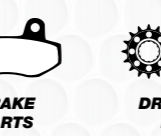
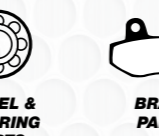
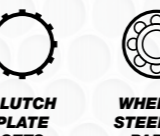
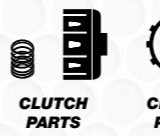

### POLARIS

**DIRT**  
APRILIA  
BETA  
BMW  
GAS GAS  
HONDA  
HUSABERG  
HUSQVARNA  
KAWASAKI  
KTM  
MOTO TM  
RIEJU  
SHERCO  
SUZUKI  
YAMAHA

**STREET**  
APRILIA  
CAGIVA  
HONDA  
KAWASAKI  
KTM  
SUZUKI  
YAMAHA

**ATV-UTV**  
CAN-AM  
GAS GAS  
HONDA  
KAWASAKI  
KTM  
POLARIS  
SUZUKI  
YAMAHA

**PWC**  
KAWASAKI  
POLARIS  
SEA DOO  
YAMAHA

**SNOW**  
ARCTIC CAT  
KAWASAKI  
LYNX  
MOTO-SKI  
POLARIS  
SKI DOO  
YAMAHA

**MOPED & SCOOTER**

**MISC. TECH. SPECIAL**

<b>Xplorer 250 4x4</b> 2-Stroke	<b>Piston kit</b> -	<b>Size</b> 72.00	<b>Ring Set</b> -			<b>Top-End</b> 35.5385 '00-02			
<b>Sportsman 300 4x4</b> 4-Stroke	<b>Piston kit</b> -	<b>Size</b> 78.50	<b>Ring Set</b> -						
<b>Trail Blazer 330</b> 4-Stroke	<b>Piston kit</b> -	<b>Size</b> 78.50	<b>Ring Set</b> -						
<b>Trail Boss 330</b> 4-Stroke	<b>Piston kit</b> -	<b>Size</b> 78.50	<b>Ring Set</b> -						
<b>Scrambler 400 4x4</b> 2-Stroke	<b>Piston kit</b> -	<b>Size</b> 83.00	<b>Ring Set</b> -			<b>Top-End</b> 35.5494 '95-02			
<b>Sport 400L</b> 2-Stroke	<b>Piston kit</b> -	<b>Size</b> 83.00	<b>Ring Set</b> -			<b>Top-End</b> 35.5494 '94-99			

Footnotes: \* Bearings Only

			<b>F/W Bearing</b> 23.S110008 '00-02 2x	<b>Front Pad Set</b> 37.206402 '00-02 Left 37.206402 '00-02 Right	<b>Chain</b> 07.RC520120C '00-02 MX 07.RC520120CG '00-02 MX Gold 07.RC520120XC '00-02 X-Ring 07.RC520120XCG '00-02 X-Ring Gold		<b>Lower A-Arm</b> 26.510048 '00-02		
			<b>R/W Bearing</b> 23.S11051 '00-02	37.206402BX '00-02 Box of 10					
			<b>F/W Bearing</b> 23.S114024 '08-10 2x	<b>Front Pad Set</b> 37.206402 '08-10 Left 37.206402 '08-10 Right	<b>Chain</b> 07.RC520120C '08-10 MX 07.RC520120CG '08-10 MX Gold 07.RC520120XC '08-10 X-Ring 07.RC520120XCG '08-10 X-Ring Gold		<b>Lower A-Arm</b> 26.510049 '08-10		
			<b>R/W Bearing</b> 23.S114024 '08-10 2x	37.206402BX '08-10 Box of 10					
			<b>Rear Pad Set</b> 37.206402 '08-10	37.206402BX '08-10 Box of 10					
			<b>F/W Bearing</b> 23.S115000 '08-09 2x	<b>Front Pad Set</b> 37.206402 '08-13 Left 37.206402 '08-13 Right	<b>Chain</b> 07.RC520120C '08-13 MX 07.RC520120CG '08-13 MX Gold 07.RC520120XC '08-13 X-Ring 07.RC520120XCG '08-13 X-Ring Gold		<b>Lower A-Arm</b> 26.510049 '08-13		
			<b>R/W Bearing</b> 23.S11051 '08-13	37.206402BX '08-13 Box of 10					
			<b>F/W Bearing</b> 23.S111029 '03-04 2x	<b>Front Pad Set</b> 37.206402 '03-12 Left 37.206402 '03-12 Right	<b>Chain</b> 07.RC520120C '03-13 MX 07.RC520120CG '03-13 MX Gold 07.RC520120XC '03-13 X-Ring 07.RC520120XCG '03-13 X-Ring Gold		<b>Lower A-Arm</b> 26.510049 '03-13		
			<b>R/W Bearing</b> 23.S115000 '05-09 2x	37.206402BX '03-12 Box of 10					
			<b>R/W Bearing</b> 23.S114024 '10-13 2x						
			<b>R/W Bearing</b> 23.S11051 '03-13						
<b>Water Pump Rebuild Kit</b> 57.7414 '95-02			<b>F/W Bearing</b> 23.S110008 '95-02 2x	<b>Front Pad Set</b> 37.206402 '95-02 Left 37.206402 '95-02 Right	<b>Chain</b> 07.RC520120C '95-02 MX 07.RC520120CG '95-02 MX Gold 07.RC520120XC '95-02 X-Ring 07.RC520120XCG '95-02 X-Ring Gold		<b>Lower A-Arm</b> 26.510048 '95-02		
			<b>R/W Bearing</b> 23.S113021 '95-97	37.206402BX '95-02 Box of 10					
			<b>R/W Bearing</b> 23.S11051 '98-02	<b>Rear Pad Set</b> 37.204402 '95-97					
				37.204402BX '95-97 Box of 10					
<b>Water Pump Rebuild Kit</b> 57.7414 '94-99			<b>F/W Bearing</b> 23.S111029 '94-99 2x	<b>Front Pad Set</b> 37.206402 '94-99 Left 37.206402 '94-99 Right	<b>Chain</b> 07.RC520120C '94-99 MX 07.RC520120CG '94-99 MX Gold 07.RC520120XC '94-99 X-Ring 07.RC520120XCG '94-99 X-Ring Gold		<b>Lower A-Arm</b> 26.510048 '94-99		
			<b>R/W Bearing</b> 23.S113021 '94-98	37.206402BX '94-99 Box of 10					
			<b>R/W Bearing</b> 23.S11051 '99	<b>Rear Pad Set</b> 37.204402 '94-98					
				37.204402BX '94-98 Box of 10					

**DIRT**  
APRILIA  
BETA  
BMW  
GAS GAS  
HONDA  
HUSABERG  
HUSQVARNA  
KAWASAKI  
KTM  
MOTO TM  
RIEJU  
SHERCO  
SUZUKI  
YAMAHA

**STREET**  
APRILIA  
CAGIVA  
HONDA  
KAWASAKI  
KTM  
SUZUKI  
YAMAHA

**ATV-UTV**  
CAN-AM  
GAS GAS  
HONDA  
KAWASAKI  
KTM  
POLARIS  
SUZUKI  
YAMAHA

**PWC**  
KAWASAKI  
POLARIS  
SEA DOO  
YAMAHA

**SNOW**  
ARCTIC CAT  
KAWASAKI  
LYNX  
MOTO-SKI  
POLARIS  
SKI DOO  
YAMAHA

**MOPED & SCOOTER**

**MISC. TECH. SPECIAL**



POLARIS

**DIRT**  
APRILIA  
BETA  
BMW  
GAS GAS  
HONDA  
HUSABERG  
HUSQVARNA  
KAWASAKI  
KTM  
MOTO TM  
RIEJU  
SHERCO  
SUZUKI  
YAMAHA

**STREET**  
APRILIA  
CAGIVA  
HONDA  
KAWASAKI  
KTM  
SUZUKI  
YAMAHA

**ATV-UTV**  
CAN-AM  
GAS GAS  
HONDA  
KAWASAKI  
KTM  
POLARIS  
SUZUKI  
YAMAHA

**PWC**  
KAWASAKI  
POLARIS  
SEA DOO  
YAMAHA

**SNOW**  
ARCTIC CAT  
KAWASAKI  
LYNX  
MOTO-SKI  
POLARIS  
SKI DOO  
YAMAHA

**MOPED & SCOOTER**

**MISC. TECH. SPECIAL**

Sportsman 400 4x4 4-Stroke	Piston kit -	Size -	Ring Set -					
	Piston kit -	Size 87.90	Ring Set -					
	Piston kit -	Size 83.00	Ring Set -					
Outlaw 450 MXR 4-Stroke Please Note: Nikasil Piston Size -Std. Compression 11.0:1 -Forged Piston	Piston kit 01.6413.A 01.6413.B 01.6413.C '08-10	Size 88.95 88.96 88.97	Ring Set 02.6413 02.6413 02.6413 '08-10  <b>Pin</b> 04.2055.5 '08-10  <b>Clips</b> 05.2012 '08-10	<b>Crank Bearing &amp; Seal Kit</b> 23.CBS64003 '08-10  <b>Bearing</b> 23.NJ206 '08-10	<b>Con. Rod Kit</b> 03.6520 '08-10  <b>B/E Bearing</b> 22.354322F '08-10  <b>Crankpin</b> 06.3564.7 '08-10	<b>Valve</b> 28.6520-1 '08-10 2x Exhaust Steel 28.6520-2 '08-10 2x Intake Steel  <b>Valve Seal</b> 35.VS026 '08-10 4x		

Footnotes: \* Bearings Only

**DIRT**  
APRILIA  
BETA  
BMW  
GAS GAS  
HONDA  
HUSABERG  
HUSQVARNA  
KAWASAKI  
KTM  
MOTO TM  
RIEJU  
SHERCO  
SUZUKI  
YAMAHA

**STREET**  
APRILIA  
CAGIVA  
HONDA  
KAWASAKI  
KTM  
SUZUKI  
YAMAHA

**ATV-UTV**  
CAN-AM  
GAS GAS  
HONDA  
KAWASAKI  
KTM  
POLARIS  
SUZUKI  
YAMAHA

**PWC**  
KAWASAKI  
POLARIS  
SEA DOO  
YAMAHA

**SNOW**  
ARCTIC CAT  
KAWASAKI  
LYNX  
MOTO-SKI  
POLARIS  
SKI DOO  
YAMAHA

**MOPED & SCOOTER**

**MISC. TECH. SPECIAL**

Water Pump Rebuild Kit 57.7414 '94-97 57.7421 '01-05		<b>F/W Bearing</b> 23.S110008 '94-04 2x 23.S114024 '05 2x  <b>R/W Bearing</b> 23.S113021 '94-97 23.S111050 '98-05	<b>Front Pad Set</b> 37.206402 '94-05 Left 37.206402 '94-05 Right 37.206402BX '94-05 Box of 10  <b>Rear Pad Set</b> 37.204402 '94-97 37.204402BX '94-97 Box of 10	<b>Chain</b> 07.RC520120C '94-96 MX 07.RC520120CG '94-96 MX Gold 07.RC520120XC '94-96 X-Ring 07.RC520120XCG '94-96 X-Ring Gold		<b>Lower A-Arm</b> 26.510048 '94-02 26.510049 '03-05
Water Pump Rebuild Kit 57.7421 '08-14		<b>F/W Bearing</b> 23.S114024 '08-14 2x  <b>R/W Bearing</b> 23.S114024 '08-10 2x 23.S111050 '11-14	<b>Front Pad Set</b> 37.206402 '08-14 Left 37.206402 '08-14 Right 37.206402BX '08-14 Box of 10  <b>Rear Pad Set</b> 37.206402 '08-14 37.206402BX '08-14 Box of 10			<b>Lower A-Arm</b> 26.510049 '08-14
Water Pump Rebuild Kit 57.7414 '95-02		<b>F/W Bearing</b> 23.S110008 '95-02 2x  <b>R/W Bearing</b> 23.S113021 '95-98 23.S111051 '99-02	<b>Front Pad Set</b> 37.206402 '95-02 Left 37.206402 '95-02 Right 37.206402BX '95-02 Box of 10  <b>Rear Pad Set</b> 37.204402 '95-98 37.204402BX '95-98 Box of 10	<b>Chain</b> 07.RC520120C '95-99 MX 07.RC520120CG '95-99 MX Gold 07.RC520120XC '95-99 X-Ring 07.RC520120XCG '95-99 X-Ring Gold		<b>Lower A-Arm</b> 26.510048 '95-02
<b>Main Jet</b> 45.100-225 '08-10 Keihin  <b>Pilot Jet</b> 46.040-085 '08-10 Keihin	<b>Spring Kit</b> 17.CS65041 '08-10	<b>Complete Plate Set</b> 16.CPS64006 '08-10  <b>Friction Set</b> 16.S54007 '08-10  <b>Steel Set</b> 16.S54010 '08-10	<b>F/W Bearing</b> 23.S115000 '08-10 2x  <b>Front Pad Set</b> 37.167102 '08-10 37.167102BX '08-10 Box of 10  <b>Rear Pad Set</b> 37.206402 '08-10 37.206402BX '08-10 Box of 10	<b>Front Sprocket</b> 07.FS62093-12 07.FS62093-13 07.FS62093-14 07.FS62093-15 '08-10  <b>Chain</b> 07.RC520120C '08-10 MX 07.RC520120CG '08-10 MX Gold 07.RC520120XC '08-10 X-Ring 07.RC520120XCG '08-10 X-Ring Gold  <b>Lower Chain Roller</b> 33.0001 '08-10  <b>Countershaft Seal Kit</b> 26.640001 '08-10		



**POLARIS**

**DIRT**  
APRILIA  
BETA  
BMW  
GAS GAS  
HONDA  
HUSABERG  
HUSQVARNA  
KAWASAKI  
KTM  
MOTO TM  
RIEJU  
SHERCO  
SUZUKI  
YAMAHA

<b>Sportsman 450 HO</b> 4-Stroke	<b>Piston kit</b> 01.5512.000 01.5512.050 01.5512.100 '16-19	<b>Size</b> 99.00 99.50 100.00	<b>Ring Set</b> 02.5512.000 02.5512.050 02.5512.100 '16-19						
<b>Scrambler 500 4x4</b> 4-Stroke	<b>Piston kit</b> 01.5513.000 01.5513.050 01.5513.100 '03-12	<b>Size</b> 92.00 92.50 93.00	<b>Ring Set</b> 02.5513.000 02.5513.050 02.5513.100 '03-12			<b>Top-End</b> 35.5596 '97-10			
<b>Sportsman 500 4x4</b> 4-Stroke	<b>Piston kit</b> 01.5513.000 01.5513.050 01.5513.100 '03-14	<b>Size</b> 92.00 92.50 93.00	<b>Ring Set</b> 02.5513.000 02.5513.050 02.5513.100 '03-14						
<b>Sportsman 500 HO 4x4</b> 4-Stroke	<b>Piston kit</b> 01.5513.000 01.5513.050 01.5513.100 '03-14	<b>Size</b> 92.00 92.50 93.00	<b>Ring Set</b> 02.5513.000 02.5513.050 02.5513.100 '03-14						
<b>Sportsman 500</b> 4-Stroke	<b>Piston kit</b> 01.5513.000 01.5513.050 01.5513.100 '03-14	<b>Size</b> 92.00 92.50 93.00	<b>Ring Set</b> 02.5513.000 02.5513.050 02.5513.100 '03-14						
<b>Outlaw 525</b> 4-Stroke Please Note: -Std. Compression 11.0:1 -Forged Piston	<b>Piston Kit</b> 01.6521.A 01.6521.B 01.6521.C '07-11	<b>Size</b> 94.94 94.95 94.96	<b>Ring Set</b> 02.6424 02.6424 02.6424 '07-11	<b>Crank Bearing &amp; Seal Kit</b> 23.CBS64003 '07-11	<b>Con. Rod Kit</b> 03.6520 '07-11	<b>Complete</b> 34.6528 '07-11	<b>Valve</b> 28.6520-1 '07-11 2x Exhaust Steel 28.6520-2 '07-11 2x Intake Steel	<b>Valve Seal</b> 35.VS026 '07-11 4x	
			<b>Pin</b> 04.2050.5 '07-11	<b>Bearing</b> 23.NJ206 '07-11	<b>B/E Bearing</b> 22.354322F '07-11	<b>Top-End</b> 35.6528 '07-11			
			<b>Clips</b> 05.2012 '07-11		<b>Crankpin</b> 06.3564.7 '07-11				

Footnotes: \* Bearings Only

<b>Air Filter</b> 52.64000 '98-12			<b>F/W Bearing</b> 23.S110008 '97-09 2x 23.S114024 '10-12 2x	<b>Front Pad Set</b> 37.206402 '97-12 Left 37.206402 '97-12 Right 37.206402BX '97-12 Box of 10	<b>Chain</b> 07.RC520120C '97-12 MX 07.RC520120CG '97-12 MX Gold 07.RC520120XC '97-12 X-Ring 07.RC520120XCG '97-12 X-Ring Gold		<b>Lower A-Arm</b> 26.510048 '97-02 26.510049 '03-12		
<b>Water Pump Rebuild Kit</b> 57.7421 '97-12			<b>R/W Bearing</b> 23.S113021 '97 23.S111051 '98-12	<b>Rear Pad Set</b> 37.204402 '97 37.204402BX '97 Box of 10					
<b>Air Filter</b> 52.64000 '96-12			<b>F/W Bearing</b> 23.S110008 '96-02 2x	<b>Front Pad Set</b> 37.206402 '96-02 Left 37.206402 '96-02 Right 37.206402BX '96-02 Box of 10			<b>Lower A-Arm</b> 26.510048 '96-02		
<b>Water Pump Rebuild Kit</b> 57.7421 '96-02			<b>R/W Bearing</b> 23.S111050 '96-02	<b>Rear Pad Set</b> 37.204402 '96-97 37.204402BX '96-97 Box of 10					
<b>Water Pump Rebuild Kit</b> 57.7421 '01-13			<b>F/W Bearing</b> 23.S110008 '01-04 2x 23.S114024 '05-13 2x	<b>Front Pad Set</b> 37.206402 '01-08 Left 37.206402 '01-08 Right 37.206402BX '01-08 Box of 10			<b>Lower A-Arm</b> 26.510048 '01-02 26.510049 '03-13		
<b>Air Filter</b> 52.64000 '08-12			<b>F/W Bearing</b> 23.S114024 '08-13 2x	<b>Front Pad Set</b> 37.206402 '08-12 Left 37.206402 '08-12 Right 37.206402BX '08-12 Box of 10			<b>Lower A-Arm</b> 26.510049 '08-12		
<b>Water Pump Rebuild Kit</b> 57.7421 '01-13			<b>R/W Bearing</b> 23.S111050 '08-13	<b>Rear Pad Set</b> 37.206402 '07-11 37.167102BX '07-11 Box of 10					
<b>Main Jet</b> 45.100-225 '07-11 Keihin	<b>Spring Kit</b> 17.CS65041 '07-11	<b>Complete Plate Set</b> 16.CPS64006 '07-11	<b>F/W Bearing</b> 23.S115000 '07-11 2x	<b>Front Pad Set</b> 37.167102 '07-11 37.167102BX '07-11 Box of 10	<b>Front Sprocket</b> 07.FS62093-12 07.FS62093-13 07.FS62093-14 07.FS62093-15 '07-11				
<b>Pilot Jet</b> 46.040-085 '07-11 Keihin		<b>Friction Set</b> 16.S54007 '07-11		<b>Rear Pad Set</b> 37.206402 '07-11 37.206402BX '07-11 Box of 10	<b>Chain</b> 07.RC520120C '07-11 MX 07.RC520120CG '07-11 MX Gold 07.RC520120XC '07-11 X-Ring 07.RC520120XCG '07-11 X-Ring Gold				
		<b>Steel Set</b> 16.S54010 '07-11			<b>Lower Chain Roller</b> 33.0001 '08-10				
					<b>Countershaft Seal Kit</b> 26.640001 '07-11				

**DIRT**  
APRILIA  
BETA  
BMW  
GAS GAS  
HONDA  
HUSABERG  
HUSQVARNA  
KAWASAKI  
KTM  
MOTO TM  
RIEJU  
SHERCO  
SUZUKI  
YAMAHA

**STREET**  
APRILIA  
CAGIVA  
HONDA  
KAWASAKI  
KTM  
SUZUKI  
YAMAHA

**ATV-UTV**  
CAN-AM  
GAS GAS  
HONDA  
KAWASAKI  
KTM  
POLARIS  
SUZUKI  
YAMAHA

**PWC**  
KAWASAKI  
POLARIS  
SEA DOO  
YAMAHA

**SNOW**  
ARCTIC CAT  
KAWASAKI  
LYNX  
MOTO-SKI  
POLARIS  
SKI DOO  
YAMAHA

**MOPED & SCOOTER**

**MISC. TECH. SPECIAL**



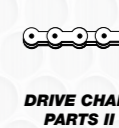

### POLARIS

Model	Piston kit	Size	Ring Set	Cam Chain	Top-End
<b>Sportsman 570</b> 4-Stroke	01.5512.000 01.5512.050 01.5512.100 '16-23	99.00 99.50 100.00	02.5512.000 02.5512.050 02.5512.100 '16-23	31.5512 '16-17	
<b>RZR 570</b> 4-Stroke	01.5512.000 01.5512.050 01.5512.100 '12-22	99.00 99.50 100.00	02.5512.000 02.5512.050 02.5512.100 '12-22	31.5512 '12-22	
<b>Ranger 570</b> 4-Stroke	01.5512.000 01.5512.050 01.5512.100 '14-23	99.00 99.50 100.00	02.5512.000 02.5512.050 02.5512.100 '14-23	31.5512 '14-21	
<b>Ace 570</b> 4-Stroke	01.5512.000 01.5512.050 01.5512.100 '15-19	99.00 99.50 100.00	02.5512.000 02.5512.050 02.5512.100 '15-19	31.5512 '15-19	
<b>Sportsman 800 EFI Non H.O.</b> 4-Stroke Please Note: Nikasil Piston Size -Std. Compression 10.0:1  -Piston OEM Reference : 2202917	01.5806.A 01.5806.B 01.5806.C '05-14	79.95 79.96 79.97	02.5805 02.5805 02.5805 '05-14	35.5805 '05-14	
<b>Sportsman 800 X2 EFI</b> 4-Stroke Please Note: Nikasil Piston Size -Std. Compression 10.0:1  -Piston OEM Reference : 2202917	01.5806.A 01.5806.B 01.5806.C '07-09	79.95 79.96 79.97	02.5805 02.5805 02.5805 '07-09	35.5805 '07-09	
<b>Sportsman 800 EFI 6X6</b> 4-Stroke Please Note: Nikasil Piston Size -Std. Compression 10.0:1  -Piston OEM Reference : 2202917	01.5806.A 01.5806.B 01.5806.C '09-15	79.95 79.96 79.97	02.5805 02.5805 02.5805 '09-15	35.5805 '09-15	
<b>Sportsman 800 EFI H.O.</b> 4-Stroke Please Note: Nikasil Piston Size -Std. Compression 10.0:1  -Piston OEM Reference : 2203715	01.5805.A 01.5805.B 01.5805.C '08-09	79.95 79.96 79.97	02.5805 02.5805 02.5805 '08-09	35.5805 '08-09	
<b>Ranger 800</b> 4-Stroke Please Note: Nikasil Piston Size -Std. Compression 10.0:1	01.5806.A 01.5806.B 01.5806.C '10-14	79.95 79.96 79.97	02.5805 02.5805 02.5805 '10-14		

Footnotes: \* Bearings Only

Model	Air Filter	Water Pump Rebuild Kit	F/W Bearing	R/W Bearing	Front Pad Set	Lower A-Arm
<b>Sportsman 570</b> 4-Stroke	52.64000 '05-14	57.7724 '05-10 57.7821 '11-14	23.S114024 '05-14 2x	23.S111050 '05-14	37.206402 '05-14 Left 37.206402 '05-14 Right 37.206402BX '05-14 Box of 10	26.510049 '05-14
<b>RZR 570</b> 4-Stroke	52.64000 '07-09	57.7724 '07-09	23.S114024 '07-09 2x	23.S111050 '07-09	37.206402 '07-09 Left 37.206402 '07-09 Right 37.206402BX '07-09 Box of 10	26.510049 '07-09
<b>Ranger 570</b> 4-Stroke	52.64000 '09-15	57.7724 '09-15	23.S114024 '09-15 2x	23.S111050 '09-15	37.206402 '09-15 Left 37.206402 '09-15 Right 37.206402BX '09-15 Box of 10	26.510049 '09-15
<b>Ace 570</b> 4-Stroke	52.64000 '08-09	57.7724 '08-09	23.S114024 '08-09 2x	23.S111050 '08-09	37.206402 '08-09 Left 37.206402 '08-09 Right 37.206402BX '08-09 Box of 10	26.510049 '08-09

**DIRT**  
APRILIA  
BETA  
BMW  
GAS GAS  
HONDA  
HUSABERG  
HUSQVARNA  
KAWASAKI  
KTM  
MOTO TM  
RIEJU  
SHERCO  
SUZUKI  
YAMAHA

**STREET**  
APRILIA  
CAGIVA  
HONDA  
KAWASAKI  
KTM  
SUZUKI  
YAMAHA

**ATV-UTV**  
CAN-AM  
GAS GAS  
HONDA  
KAWASAKI  
KTM  
POLARIS  
SUZUKI  
YAMAHA

**PWC**  
KAWASAKI  
POLARIS  
SEA DOO  
YAMAHA

**SNOW**  
ARCTIC CAT  
KAWASAKI  
LYNX  
MOTO-SKI  
POLARIS  
SKI DOO  
YAMAHA

**MOPED & SCOOTER**

**MISC. TECH. SPECIAL**

**DIRT**  
APRILIA  
BETA  
BMW  
GAS GAS  
HONDA  
HUSABERG  
HUSQVARNA  
KAWASAKI  
KTM  
MOTO TM  
RIEJU  
SHERCO  
SUZUKI  
YAMAHA

**STREET**  
APRILIA  
CAGIVA  
HONDA  
KAWASAKI  
KTM  
SUZUKI  
YAMAHA

**ATV-UTV**  
CAN-AM  
GAS GAS  
HONDA  
KAWASAKI  
KTM  
POLARIS  
SUZUKI  
YAMAHA

**PWC**  
KAWASAKI  
POLARIS  
SEA DOO  
YAMAHA

**SNOW**  
ARCTIC CAT  
KAWASAKI  
LYNX  
MOTO-SKI  
POLARIS  
SKI DOO  
YAMAHA

**MOPED & SCOOTER**

**MISC. TECH. SPECIAL**



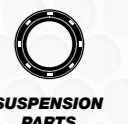

### POLARIS

**DIRT**  
 APRILIA  
 BETA  
 BMW  
 GAS GAS  
 HONDA  
 HUSABERG  
 HUSQVARNA  
 KAWASAKI  
 KTM  
 MOTO TM  
 RIEJU  
 SHERCO  
 SUZUKI  
 YAMAHA

**STREET**  
 APRILIA  
 CAGIVA  
 HONDA  
 KAWASAKI  
 KTM  
 SUZUKI  
 YAMAHA

**ATV-UTV**  
 CAN-AM  
 GAS GAS  
 HONDA  
 KAWASAKI  
 KTM  
 POLARIS  
 SUZUKI  
 YAMAHA

**PWC**  
 KAWASAKI  
 POLARIS  
 SEA DOO  
 YAMAHA

**SNOW**  
 ARCTIC CAT  
 KAWASAKI  
 LYNX  
 MOTO-SKI  
 POLARIS  
 SKI DOO  
 YAMAHA

**MOPED & SCOOTER**

**MISC. TECH. SPECIAL**

Model	Piston kit	Size (mm)	Ring Set	Cam Chain
<b>RZR 800</b> 4-Stroke Please Note: Nikasil Piston Size -Std. Compression 10.0:1 -Piston OEM Reference : 2202917	01.5806.A 01.5806.B 01.5806.C	79.95 79.96 79.97	02.5805 02.5805 02.5805	
<b>RZR S 800 EFI</b> 4-Stroke Please Note: Nikasil Piston Size -Std. Compression 10.0:1 -Piston OEM Reference : 2203715	01.5805.A 01.5805.B 01.5805.C	79.95 79.96 79.97	02.5805 02.5805 02.5805	
<b>RZR 4 800 EFI</b> 4-Stroke Please Note: Nikasil Piston Size -Std. Compression 10.0:1 -Piston OEM Reference : 2203715	01.5805.A 01.5805.B 01.5805.C	79.95 79.96 79.97	02.5805 02.5805 02.5805	
<b>Ranger XP 900</b> 4-Stroke Please Note: Nikasil Piston Size	01.5913.A 01.5913.B 01.5913.C	92.95 92.96 92.97	02.5913 02.5913 02.5913	31.5511 '11-14
<b>RZR 900</b> 4-Stroke Please Note: Nikasil Piston Size	01.5913.A 01.5913.B 01.5913.C	92.95 92.96 92.97	02.5913 02.5913 02.5913	31.5512 '15-22
<b>Ace 900</b> 4-Stroke Please Note: Nikasil Piston Size	01.5913.A 01.5913.B 01.5913.C	92.95 92.96 92.97	02.5913 02.5913 02.5913	31.5512 '16-19
<b>Ranger XP 1000</b> 4-Stroke Please Note: Nikasil Piston Size	01.5913.A 01.5913.B 01.5913.C	92.95 92.96 92.97	02.5913 02.5913 02.5913	31.5512 '17-22
<b>RZR 1000</b> 4-Stroke Please Note: Nikasil Piston Size	01.5913.A 01.5913.A 01.5913.A	92.95 92.96 92.97	02.5913 02.5913 02.5913	31.5512 '14-22
<b>RZR RS1</b> 4-Stroke Please Note: Nikasil Piston Size	01.5913.A 01.5913.B 01.5913.C	92.95 92.96 92.97	02.5913 02.5913 02.5913	31.5512 '18-22
<b>General 1000</b> 4-Stroke Please Note: Nikasil Piston Size	01.5913.A 01.5913.B 01.5913.C	92.95 92.96 92.97	02.5913 02.5913 02.5913	31.5512 '16-23

Footnotes: \* Bearings Only

**DIRT**  
 APRILIA  
 BETA  
 BMW  
 GAS GAS  
 HONDA  
 HUSABERG  
 HUSQVARNA  
 KAWASAKI  
 KTM  
 MOTO TM  
 RIEJU  
 SHERCO  
 SUZUKI  
 YAMAHA

**STREET**  
 APRILIA  
 CAGIVA  
 HONDA  
 KAWASAKI  
 KTM  
 SUZUKI  
 YAMAHA

**ATV-UTV**  
 CAN-AM  
 GAS GAS  
 HONDA  
 KAWASAKI  
 KTM  
 POLARIS  
 SUZUKI  
 YAMAHA

**PWC**  
 KAWASAKI  
 POLARIS  
 SEA DOO  
 YAMAHA

**SNOW**  
 ARCTIC CAT  
 KAWASAKI  
 LYNX  
 MOTO-SKI  
 POLARIS  
 SKI DOO  
 YAMAHA

**MOPED & SCOOTER**

**MISC. TECH. SPECIAL**

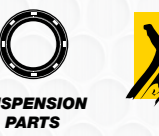
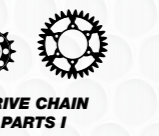
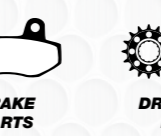
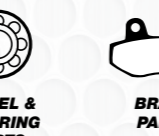
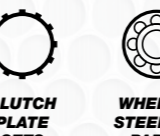
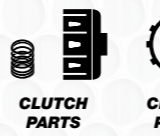

### SUZUKI

**DIRT**  
 APRILIA  
 BETA  
 BMW  
 GAS GAS  
 HONDA  
 HUSABERG  
 HUSQVARNA  
 KAWASAKI  
 KTM  
 MOTO TM  
 RIEJU  
 SHERCO  
 SUZUKI  
 YAMAHA

**STREET**  
 APRILIA  
 CAGIVA  
 HONDA  
 KAWASAKI  
 KTM  
 SUZUKI  
 YAMAHA

**ATV-UTV**  
 CAN-AM  
 GAS GAS  
 HONDA  
 KAWASAKI  
 KTM  
 POLARIS  
 SUZUKI  
 YAMAHA

**PWC**  
 KAWASAKI  
 POLARIS  
 SEA DOO  
 YAMAHA

**SNOW**  
 ARCTIC CAT  
 KAWASAKI  
 LYNX  
 MOTO-SKI  
 POLARIS  
 SKI DOO  
 YAMAHA

**MOPED & SCOOTER**

**MISC. TECH. SPECIAL**

Model	Stroke	Piston kit	Size (mm)	Ring Set	Bearing	S/E Bearing	Top-End	Valve Seal
LT 50	2-Stroke	01.3001.000 01.3001.050 01.3001.100 01.3001.150 01.3001.200 '84-06	41.00 41.50 42.00 42.50 43.00	- 02.3001.100 02.3001.150 -	23.6203C3 '84-06 2x	21.3001 '84-06	35.3001 '84-06	
LT 80	2-Stroke	01.3180.000 01.3180.050 01.3180.100 01.3180.150 '87-06	50.00 50.50 51.00 51.50	02.3180.000 02.3180.050 02.3180.100 02.3180.150 '87-06  Clips 05.1210C '87-06	23.6204C3 '87-06 2x	21.3001 '87-06	34.3180 '87-06  Top-End 35.3180 '87-06	
LT 250 R	2-Stroke	-	67.00	-  Pin 04.1856 '88-92  Clips 05.1812 '88-92	Crank Bearing & Seal Kit 23.CBS33088 '88-92  Bearing 23.6232C3 Left 23.6206C3 Right '88-92  Oilseal Set 42.3350 '87-92			35.VS020 '88-01 2x
LT-F 250 Quadrunner	4-Stroke	-	66.00	-			35.3388 '88-01	35.VS020 '88-01 2x
LT-F 250 Ozark	4-Stroke -Std. Compression 9.2:1	-	66.00	-			35.3302 '02-14	35.VS020 '02-14 2x

Footnotes: \* Bearings Only

Model	Stroke	Air Filter	R/W Bearing	Chain	Swingarm	Rear Shock Seal Head Kit
LT 50	2-Stroke		23.S113064 '84-87	07.RC420130C '84-06 MX		
LT 80	2-Stroke	52.31087 '87-06		07.RC428130C '87-88 MX 07.RC520120C '89-06 MX 07.RC520120CG '89-06 MX Gold 07.RC520120XC '89-06 X-Ring 07.RC520120XCG '89-06 X-Ring Gold	26.210005 '85-92  Linkage 26.110102 '85-86 26.110050 '87-90 26.110063 '91-92  Lower 26.310008 '85-86 26.450020 '87-90 26.450009 '91-92  Upper 26.310008 '85-90	
LT 250 R	2-Stroke		F/W Bearing 23.S110042 '85-92 2x  R/W Bearing 23.S113031 '85-92	37.BD13402 '85-92 2x  Front Caliper Rebuild Kit 37.63024 '85-92  Rear Caliper Rebuild Kit 37.63038 '85-92  Front Master Cylinder Rebuild Kit 37.910001 '85-90 37.910004 '91-92  Rear Master Cylinder Rebuild Kit 37.910007 '85-92	07.RC520120C '88-92 MX 07.RC520120CG '88-92 MX Gold 07.RC520120XC '88-92 X-Ring 07.RC520120XCG '88-92 X-Ring Gold	26.810010 '85-92
LT-F 250 Quadrunner	4-Stroke	52.32088 '88-01	F/W Bearing 23.S111008 '88-01 2x  R/W Bearing 23.S112099 '88-01 2x	37.BD13402 '87-93 2x  Front Master Cylinder Rebuild Kit 37.910012 '88-01		
LT-F 250 Ozark	4-Stroke		F/W Bearing 23.S112015 '02-14 2x  R/W Bearing 23.S114078 '02-14	37.202002 '02-14 Left 37.202002 '02-14 Right 37.202002BX '02-14 Box of 10  Front Caliper Rebuild Kit 37.63023 '02-14  Front Master Cylinder Rebuild Kit 37.910012 '02-14		

**DIRT**  
 APRILIA  
 BETA  
 BMW  
 GAS GAS  
 HONDA  
 HUSABERG  
 HUSQVARNA  
 KAWASAKI  
 KTM  
 MOTO TM  
 RIEJU  
 SHERCO  
 SUZUKI  
 YAMAHA

**STREET**  
 APRILIA  
 CAGIVA  
 HONDA  
 KAWASAKI  
 KTM  
 SUZUKI  
 YAMAHA

**ATV-UTV**  
 CAN-AM  
 GAS GAS  
 HONDA  
 KAWASAKI  
 KTM  
 POLARIS  
 SUZUKI  
 YAMAHA

**PWC**  
 KAWASAKI  
 POLARIS  
 SEA DOO  
 YAMAHA

**SNOW**  
 ARCTIC CAT  
 KAWASAKI  
 LYNX  
 MOTO-SKI  
 POLARIS  
 SKI DOO  
 YAMAHA

**MOPED & SCOOTER**

**MISC. TECH. SPECIAL**

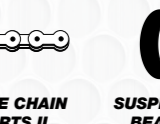

### SUZUKI

**DIRT**  
APRILIA  
BETA  
BMW  
GAS GAS  
HONDA  
HUSABERG  
HUSQVARNA  
KAWASAKI  
KTM  
MOTO TM  
RIEJU  
SHERCO  
SUZUKI  
YAMAHA

**STREET**  
APRILIA  
CAGIVA  
HONDA  
KAWASAKI  
KTM  
SUZUKI  
YAMAHA

**ATV-UTV**  
CAN-AM  
GAS GAS  
HONDA  
KAWASAKI  
KTM  
POLARIS  
SUZUKI  
YAMAHA

**PWC**  
KAWASAKI  
POLARIS  
SEA DOO  
YAMAHA

**SNOW**  
ARCTIC CAT  
KAWASAKI  
LYNX  
MOTO-SKI  
POLARIS  
SKI DOO  
YAMAHA

**MOPED & SCOOTER**

**MISC. TECH. SPECIAL**

Model	Piston kit	Size (mm)	Ring Set		Top-End	Valve Seal
LT-Z 250 QuadSport 4-Stroke -Std. Compression 9.2:1	-	66.00	-		35.3302 '04-09	35.VS020 '04-09 2x
LT-F 300 X King Quad 4-Stroke	-	68.50	-		35.3399 '91-98	35.VS020 '91-98 2x
LT-F 300 F King Quad 4-Stroke -Std. Compression 8.9:1	-	68.50	-		35.3399 '99-02	35.VS020 '99-02 2x
LT-A/F 400 F Eiger 4-Stroke -Std. Compression 9.0:1	-	82.00	-	Bearing 23.6207C3 '02-07 2x	35.3402 '02-07	35.VS019 '02-07 4x
LT-A/F 400 F King Quad 4-Stroke -Std. Compression 9.0:1	-	82.00	-	Bearing 23.6207C3 '08-15 2x	35.3402 '08-15	35.VS019 '08-15 4x

Footnotes: \* Bearings Only

			F/W Bearing 23.S110042 '04-09 2x	Front Pad Set 37.200802 '04-09 Left 37.200802 '04-09 Right 37.200802BX '04-09 Box of 10		
			R/W Bearing 23.S114078 '04-09	Front Caliper Rebuild Kit 37.63023 '04-09		
				Front Master Cylinder Rebuild Kit 37.910004 '04-09		
Air Filter 52.32088 '91-98			F/W Bearing 23.S111008 '91-98 2x			
			R/W Bearing 23.S112099 '91-98 2x			
Air Filter 52.32088 '99-02			F/W Bearing 23.S111008 '99-02 2x	Front Pad Set 37.100202 '99-02 Left 37.100202BX '99-02 Box of 10 37.204302 '99-02 Right 37.204302BX '99-02 Box of 10		
			R/W Bearing 23.S112099 '99-02 2x	Front Master Cylinder Rebuild Kit 37.910012 '99-02		
Air Filter 52.34003 '02-07			F/W Bearing 23.S111008 '02-07 2x	Front Pad Set 37.202002 '02-07 Left 37.202002 '02-07 Right 37.202002BX '02-07 Box of 10		
			R/W Bearing 23.S112093 '02-07 2x	Front Caliper Rebuild Kit 37.63023 '02-07		
				Cylinder Rebuild Kit 37.910012 '02-07		
Air Filter 52.34003 '08-15			F/W Bearing 23.S111008 '08-15 2x	Front Pad Set 37.236102 '08-15 Left 37.236102BX '08-15 Box of 10 37.246102 '08-15 Right 37.246102BX '08-15 Box of 10		
			R/W Bearing 23.S112093 '08-15 2x	Front Caliper Rebuild Kit 37.63026 '08-15		
				Front Master Cylinder Rebuild Kit 37.910012 '08-15		

**DIRT**  
APRILIA  
BETA  
BMW  
GAS GAS  
HONDA  
HUSABERG  
HUSQVARNA  
KAWASAKI  
KTM  
MOTO TM  
RIEJU  
SHERCO  
SUZUKI  
YAMAHA

**STREET**  
APRILIA  
CAGIVA  
HONDA  
KAWASAKI  
KTM  
SUZUKI  
YAMAHA

**ATV-UTV**  
CAN-AM  
GAS GAS  
HONDA  
KAWASAKI  
KTM  
POLARIS  
SUZUKI  
YAMAHA

**PWC**  
KAWASAKI  
POLARIS  
SEA DOO  
YAMAHA

**SNOW**  
ARCTIC CAT  
KAWASAKI  
LYNX  
MOTO-SKI  
POLARIS  
SKI DOO  
YAMAHA

**MOPED & SCOOTER**

**MISC. TECH. SPECIAL**





### SUZUKI

**DIRT**  
APRILIA  
BETA  
BMW  
GAS GAS  
HONDA  
HUSABERG  
HUSQVARNA  
KAWASAKI  
KTM  
MOTO TM  
RIEJU  
SHERCO  
SUZUKI  
YAMAHA

**STREET**  
APRILIA  
CAGIVA  
HONDA  
KAWASAKI  
KTM  
SUZUKI  
YAMAHA

**ATV-UTV**  
CAN-AM  
GAS GAS  
HONDA  
KAWASAKI  
KTM  
POLARIS  
SUZUKI  
YAMAHA

**PWC**  
KAWASAKI  
POLARIS  
SEA DOO  
YAMAHA

**SNOW**  
ARCTIC CAT  
KAWASAKI  
LYNX  
MOTO-SKI  
POLARIS  
SKI DOO  
YAMAHA

**MOPED & SCOOTER**

**MISC. TECH. SPECIAL**

<b>LT-Z 400</b> 4-Stroke Please Note: Nikasil Piston Size -Std. Compression 12.2:1 -Forged Piston -Fuel Injection from '09	<b>Piston kit</b> 01.3420.A 01.3420.B 01.3420.C '03-18	<b>Size</b> 89.96 89.97 89.98	<b>Ring Set</b> 02.3402 02.3402 02.3402 '03-18	<b>Crank Bearing &amp; Seal Kit</b> 23.CBS34000* '03-18	<b>Con. Rod Kit</b> 03.3402 '03-18	<b>Complete</b> 34.3423 '03-08 34.3424 '09-14	<b>Cam Chain</b> 31.3403 '03-18	<b>Valve</b> 28.3402-1 '03-18 2x Exhaust Steel 28.3402-2 '03-18 2x Intake Steel
			<b>Clips</b> 05.2012 '03-18	<b>Bearing</b> 23.6306R/3 '03-18 2x	<b>B/E Bearing</b> 22.354322F '03-18	<b>Top-End</b> 35.3423 '03-11 35.3412 '12-18	<b>Valve Shim Assortment</b> 29.VSA948 '03-18 29.VSA948-2 '03-18	<b>Valve Seal</b> 35.VS019 '03-18 2x Intake 35.VS019 '03-18 2x Exhaust

<b>LT-R 450</b> 4-Stroke Please Note: Nikasil Piston Size -Std. Compression 11.7:1 -Forged Piston -Fuel Injection	<b>Piston kit</b> 01.3406.A 01.3406.B 01.3406.C '06-11	<b>Size</b> 95.46 95.47 95.48	<b>Ring Set</b> 02.3406 02.3406 02.3406 '06-11	<b>Crank Bearing &amp; Seal Kit</b> 23.CBS34006* '06-11		<b>Complete</b> 34.3426 '06-08 34.3429 '09-11	<b>Cam Chain</b> 31.2706 '06-11	<b>Valve</b> 28.3406-1 '06-11 2x Exhaust Titanium 28.3406-2 '06-11 2x Intake Titanium
	<b>High Compression</b> 01.3407.A 01.3407.B '06-11	<b>Size</b> 95.46 95.47	<b>Ring Set</b> 02.3406 02.3406 '06-11	<b>Bearing</b> 23.6332R '06-11 Left 23.TMB306 '06-11 Right		<b>Top-End</b> 35.3426 '06-11	<b>Valve Shim Assortment</b> 29.VSA948 '06-11 29.VSA948-2 '06-11	<b>Ti-Steel Conversion Set</b> 28.SES3406-1 '06-11 Exhaust 28.SIS3406-2 '06-11 Intake
			<b>Pin</b> 04.1947.5 '06-11					<b>Valve Seal</b> 35.VS020 '06-11 2x Intake 35.VS020 '06-11 2x Exhaust

<b>LT-A 450 X King Quad</b> 4-Stroke -Std. Compression 10.0:1	<b>Piston kit</b> -	<b>Size</b> 84.00	<b>Ring Set</b> -				<b>Cam Chain</b> 31.1900 '07-09	<b>Valve Seal</b> 35.VS019 '07-10 4x
---	------------------------	----------------------	----------------------	--	--	--	---------------------------------------	--

Footnotes: \* Bearings Only

<b>Air Filter</b> 52.34003 '03-18	<b>Basket</b> 17.3400F '03-18	<b>Friction Set</b> 16.S34015 '03-04 16.S34019 '05	<b>F/W Bearing</b> 23.S110042 '03-14 2x	<b>Frontbrake Disc</b> 37.BD13402 '03-13 2x	<b>Front Sprocket</b> 07.FS34003-14 07.FS34003-15 '03-18	<b>Swingarm</b> 26.210094 '03-14	<b>Rear Shock Seal Head Kit</b> 26.810006 '03-08
<b>Throttle Cable</b> 53.110098 '03-08	<b>Pressure Plate</b> 18.P3402 '03-04	<b>Steel Set</b> 16.S34016 '03-04 16.S34020 '05	<b>R/W Bearing</b> 23.S113031 '03-08 23.S114079 '09-14	<b>Rearbrake Disc</b> 37.BD21409 '03-13	<b>Chain</b> 07.RC520120C '03-18 MX 07.RC520120CG '03-18 MX Gold 07.RC520120XC '03-18 X-Ring 07.RC520120XCG '03-18 X-Ring Gold	<b>Linkage</b> 26.110093 '03-08 26.110174 '09-14	
<b>Oil Filter</b> 54.34139 '03-18 1-Pce. 54.34139-50 '03-18 50-Pcs.	<b>Spring Kit</b> 17.CS44019 '03-18			<b>Front Pad Set</b> 37.200802 '03-18 37.200802BX '03-18 Box of 10		<b>Lower</b> 26.450025 '03-14	
<b>Water Pump Rebuild Kit</b> 57.3422 '03-08 57.3429 '09-14	<b>Cover Gasket</b> 19.G3403 '03-08 19.G3409 '09-18			<b>Rear Pad Set</b> 37.207402 '03-18 37.207402BX '03-18 Box of 10	<b>Lower Chain Roller</b> 33.0001 '03-18		
	<b>Clutch Cable</b> 53.120067 '03-14			<b>Front Caliper Rebuild Kit</b> 37.63023 '03-14			
				<b>Rear Caliper Rebuild Kit</b> 37.63038 '03-14			
				<b>Front Master Cylinder Rebuild Kit</b> 37.910004 '03-14			
				<b>Rear Master Cylinder Rebuild Kit</b> 37.910003 '03-14			

<b>Air Filter</b> 52.34006 '06-11	<b>Inner Hub</b> 18.3405 '06-07	<b>Complete Plate Set</b> 16.CPS34006 '06-11	<b>F/W Bearing</b> 23.S110042 '06-11 2x	<b>Frontbrake Disc</b> 37.BD13406 '06-11 2x	<b>Front Sprocket</b> 07.FS34003-14 07.FS34003-15 '06-11	<b>Swingarm</b> 26.210172 '06-11	<b>Rear Shock Seal Head Kit</b> 26.810119 '06-11
<b>Oil Filter</b> 54.34139 '06-11 1-Pce. 54.34139-50 '06-11 50-Pcs.	<b>Pressure Plate</b> 18.P3405 '06-07 18.P3408 '08-11	<b>Friction Set</b> 16.S34021 '06-11	<b>R/W Bearing</b> 23.S115034 '06-11 2x	<b>Rearbrake Disc</b> 37.BD23406 '06-11	<b>Chain</b> 07.RC520120C '06-11 MX 07.RC520120CG '06-11 MX Gold 07.RC520120XC '06-11 X-Ring 07.RC520120XCG '06-11 X-Ring Gold	<b>Linkage</b> 26.110150 '06-11	
<b>Water Pump Rebuild Kit</b> 57.3426 '06-11	<b>Spring Kit</b> 17.CS33025 '06-11	<b>Steel Set</b> 16.S34018 '06-11		<b>Front Pad Set</b> 37.100202 '06-11 Left 37.100202BX '06-11 Box of 10 37.204302 '06-11 Right 37.204302BX '06-11 Box of 10		<b>Lower</b> 26.450025 '06-11	
	<b>Cover Gasket</b> 19.G3406 '06-11			<b>Rear Pad Set</b> 37.207402 '06-11 37.207402BX '06-11 Box of 10	<b>Lower Chain Roller</b> 33.0002 '06-11	<b>Upper</b> 26.310003 '06-11	
				<b>Front Caliper Rebuild Kit</b> 37.63009 '06-11	<b>Upper Chain Roller</b> 33.0001 '06-11		

			<b>F/W Bearing</b> 23.S115038 '07-10 2x	<b>Front Pad Set</b> 37.236102 '07-10 Left 37.236102BX '07-10 Box of 10 37.246102 '07-10 Right 37.246102BX '07-10 Box of 10		<b>Upper A-Arm</b> 26.510037 '07-10	
			<b>R/W Bearing</b> 23.S115037 '07-10 2x	<b>Front Caliper Rebuild Kit</b> 37.63026 '07-10			

**DIRT**  
APRILIA  
BETA  
BMW  
GAS GAS  
HONDA  
HUSABERG  
HUSQVARNA  
KAWASAKI  
KTM  
MOTO TM  
RIEJU  
SHERCO  
SUZUKI  
YAMAHA

**STREET**  
APRILIA  
CAGIVA  
HONDA  
KAWASAKI  
KTM  
SUZUKI  
YAMAHA

**ATV-UTV**  
CAN-AM  
GAS GAS  
HONDA  
KAWASAKI  
KTM  
POLARIS  
SUZUKI  
YAMAHA

**PWC**  
KAWASAKI  
POLARIS  
SEA DOO  
YAMAHA

**SNOW**  
ARCTIC CAT  
KAWASAKI  
LYNX  
MOTO-SKI  
POLARIS  
SKI DOO  
YAMAHA

**MOPED & SCOOTER**

**MISC. TECH. SPECIAL**

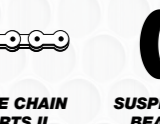

### SUZUKI

**DIRT**  
APRILIA  
BETA  
BMW  
GAS GAS  
HONDA  
HUSABERG  
HUSQVARNA  
KAWASAKI  
KTM  
MOTO TM  
RIEJU  
SHERCO  
SUZUKI  
YAMAHA

**STREET**  
APRILIA  
CAGIVA  
HONDA  
KAWASAKI  
KTM  
SUZUKI  
YAMAHA

**ATV-UTV**  
CAN-AM  
GAS GAS  
HONDA  
KAWASAKI  
KTM  
POLARIS  
SUZUKI  
YAMAHA

**PWC**  
KAWASAKI  
POLARIS  
SEA DOO  
YAMAHA

**SNOW**  
ARCTIC CAT  
KAWASAKI  
LYNX  
MOTO-SKI  
POLARIS  
SKI DOO  
YAMAHA

**MOPED & SCOOTER**

**MISC. TECH. SPECIAL**

LT-A/F 500 F Vinson 4-Stroke -Std. Compression 10.2:1	Piston kit -	Size 87.50	Ring Set -			Top-End 35.3598 '02-07	Cam Chain 31.1900 '03-07	Valve Seal 35.VS019 '02-07 4x
LT-A 700 X King Quad 4-Stroke -Std. Compression 10.0:1	Piston kit -	Size 102.00	Ring Set -				Cam Chain 31.1993 '05-07	Valve Seal 35.VS020 '05-07 2x Intake 35.VS020 '05-07 2x Exhaust
LT-V 700 F Twin Peaks 4-Stroke -Std. Compression 9.9:1	Piston kit -	Size 82.00	Ring Set -			Complete 34.4704 '04-05  Top-End 35.4704 '04-05		Valve Seal 35.VS024 '04-05 8x
LT-A 750 X King Quad 4-Stroke -Std. Compression 10.0:1	Piston kit -	Size 104.00	Ring Set -				Cam Chain 31.1993 '08-21	Valve Seal 35.VS020 '08-15 4x

Footnotes: \* Bearings Only

**DIRT**  
APRILIA  
BETA  
BMW  
GAS GAS  
HONDA  
HUSABERG  
HUSQVARNA  
KAWASAKI  
KTM  
MOTO TM  
RIEJU  
SHERCO  
SUZUKI  
YAMAHA

**STREET**  
APRILIA  
CAGIVA  
HONDA  
KAWASAKI  
KTM  
SUZUKI  
YAMAHA

**ATV-UTV**  
CAN-AM  
GAS GAS  
HONDA  
KAWASAKI  
KTM  
POLARIS  
SUZUKI  
YAMAHA

**PWC**  
KAWASAKI  
POLARIS  
SEA DOO  
YAMAHA

**SNOW**  
ARCTIC CAT  
KAWASAKI  
LYNX  
MOTO-SKI  
POLARIS  
SKI DOO  
YAMAHA

**MOPED & SCOOTER**

**MISC. TECH. SPECIAL**

Air Filter 52.34003 '02-07			F/W Bearing 23.S111008 '02-07 2x	Front Pad Set 37.202002 '02-07 Left 37.202002 '02-07 Right 37.202002BX '02-07 Box of 10				
Water Pump Rebuild Kit 57.3522 '02-07			R/W Bearing 23.S112093 '02-07 2x	Rear Pad Set 37.105002 '02-07 37.105002BX '02-07 Box of 10				
				Front Caliper Rebuild Kit 37.63023 '02-07 LT-A 37.63009 '98-02 LT-F 37.63023 '03-07 LT-F				
				Rear Caliper Rebuild Kit 37.63039 '03-07				
			F/W Bearing 23.S115038 '05-07 2x	Front Pad Set 37.236102 '05-07 Left 37.236102BX '05-07 Box of 10				Upper A-Arm 26.510037 '05-07
			R/W Bearing 23.S115037 '05-07 2x	37.246102 '05-07 Right 37.246102BX '05-07 Box of 10				
				Front Caliper Rebuild Kit 37.63026 '05-07				
			F/W Bearing 23.S114097 '04-05 2x	Front Pad Set 37.209402 '04-05 Left 37.209402BX '04-05 Box of 10				
				37.106202 '04-05 Right 37.106202BX '04-05 Box of 10				
				Front Caliper Rebuild Kit 37.63025 '04-05				
			F/W Bearing 23.S115038 '08-15 2x	Front Pad Set 37.236102 '08-15 Left 37.236102BX '08-15 Box of 10				
			R/W Bearing 23.S115037 '08-15 2x	37.246102 '08-15 Right 37.246102BX '08-15 Box of 10				
				Front Caliper Rebuild Kit 37.63026 '08-15				

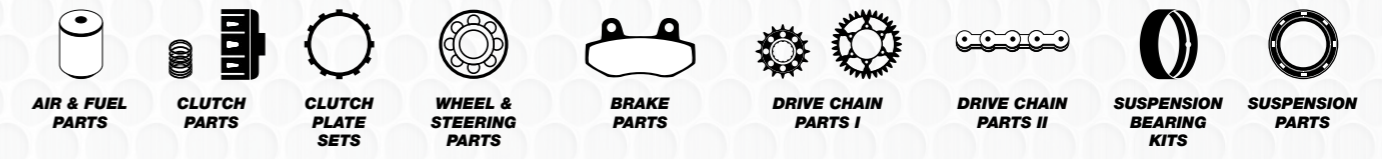

### YAMAHA

**DIRT**  
APRILIA  
BETA  
BMW  
GAS GAS  
HONDA  
HUSABERG  
HUSQVARNA  
KAWASAKI  
KTM  
MOTO TM  
RIEJU  
SHERCO  
SUZUKI  
YAMAHA

<b>YFM 80 Badger</b> 4-Stroke	<b>Piston kit</b> -	<b>Size</b> 47.00	<b>Ring Set</b> -						
<b>YFM 80 Grizzly</b> 4-Stroke	<b>Piston kit</b> -	<b>Size</b> 47.00	<b>Ring Set</b> -						
<b>YFM 80 Raptor</b> 4-Stroke	<b>Piston kit</b> -	<b>Size</b> 47.00	<b>Ring Set</b> -						
<b>YFM 125 R Raptor</b> 4-Stroke	<b>Piston kit</b> -	<b>Size</b> 54.00	<b>Ring Set</b> -				<b>Cam Chain</b> 31.2211 '11-13		

**STREET**  
APRILIA  
CAGIVA  
HONDA  
KAWASAKI  
KTM  
SUZUKI  
YAMAHA

<b>YFS 200 Blaster</b> 2-Stroke -Molycoated Skirt	<b>Piston kit</b> 01.2281.000 01.2281.025 01.2281.050 01.2281.075 01.2281.100 01.2281.125 01.2281.150 01.2281.175 01.2281.200 '88-06	<b>Size</b> 66.00 66.25 66.50 66.75 67.00 67.25 67.50 67.75 68.00	<b>Ring Set</b> 02.2281.000 02.2281.025 02.2281.050 02.2281.075 02.2281.100 02.2281.125 02.2281.150 02.2281.175 02.2281.200 '88-06	<b>Crank Bearing &amp; Seal Kit</b> 23.CBS22088 '88-04 23.CBS22105 '05-06  <b>Bearing</b> 23.83A915 '88-06 Left 23.6305RI '88-06 Right <b>Oilseal Set</b> 42.2280 '88-04 or 42.2281 '88-04 Teflon 42.2285 '05-06	<b>Con. Rod Kit</b> 03.2310F '88-06  <b>S/E Bearing</b> 21.2020 '88-06  <b>B/E Bearing</b> 22.222917F '88-06  <b>Crankpin</b> 06.2256.5 '88-06	<b>Complete</b> 34.2280 '88-06  <b>Top-End</b> 35.2280 '88-06			
---	--	--	--	---	--	---	--	--	--

**ATV-UTV**  
CAN-AM  
GAS GAS  
HONDA  
KAWASAKI  
KTM  
POLARIS  
SUZUKI  
YAMAHA

			<b>Pin</b> 04.1654 '88-06  <b>Clips</b> 05.1612C '88-06						
--	--	--	---	--	--	--	--	--	--

**PWC**  
KAWASAKI  
POLARIS  
SEA DOO  
YAMAHA

--	--	--	--	--	--	--	--	--	--

**SNOW**  
ARCTIC CAT  
KAWASAKI  
LYNX  
MOTO-SKI  
POLARIS  
SKI DOO  
YAMAHA

--	--	--	--	--	--	--	--	--	--

**MOPED & SCOOTER**

--	--	--	--	--	--	--	--	--	--

**MISC. TECH. SPECIAL**

--	--	--	--	--	--	--	--	--	--

Footnotes: \* Bearings Only

**DIRT**  
APRILIA  
BETA  
BMW  
GAS GAS  
HONDA  
HUSABERG  
HUSQVARNA  
KAWASAKI  
KTM  
MOTO TM  
RIEJU  
SHERCO  
SUZUKI  
YAMAHA

			<b>F/W Bearing</b> 23.S111004 '85-86 2x 23.S110052 '87-01 2x						
			<b>F/W Bearing</b> 23.S110052 '05-08 2x						
			<b>F/W Bearing</b> 23.S110052 '02-08 2x						
				<b>Rearbrake Disc</b> 37.BD22208 '11-13					

**STREET**  
APRILIA  
CAGIVA  
HONDA  
KAWASAKI  
KTM  
SUZUKI  
YAMAHA

<b>Air Filter</b> 52.23008 '88-06	<b>Basket</b> 17.2281F '88-06	<b>Complete Plate Set</b> 16.CPS22088 '88-06	<b>F/W Bearing</b> 23.S110048 '88-02 2x 23.S110044 '03-06 2x	<b>Frontbrake Disc</b> 37.BD12409 '03-06 2x	<b>Front Sprocket</b> 07.FS22088-13 07.FS22088-14 '88-06	<b>Swingarm</b> 26.210023 '88-06	<b>Lower A-Arm</b> 26.510009 '88-06
<b>Main Jet</b> 47.090-580 '88-06 Mikuni	<b>Spring Kit</b> 17.CS22040 '88-06	<b>Friction Set</b> 16.S22024 '88-06	<b>R/W Bearing</b> 23.S113014 '88-02 23.S113013 '03-06	<b>Rearbrake Disc</b> 37.BD22602 '88-06	<b>Chain</b> 07.RC520120C '88-06 MX 07.RC520120CG '88-06 MX Gold 07.RC520120XC '88-06 X-Ring 07.RC520120XCG '88-06 X-Ring Gold		
<b>Carburetor Rebuild Kit</b> 55.10379 '88-06	<b>Cover Gasket</b> 19.G2288 '88-06	<b>Steel Set</b> 16.S22025 '88-06		<b>Front Pad Set</b> 37.202002 '03-06 37.202002BX '03-06 Box of 10			
				<b>Rear Pad Set</b> 37.209802 '91-02 37.200802 '03-06 37.200802BX '03-06 Box of 10	<b>Lower Chain Roller</b> 33.0009 '88-06		
				<b>Front Caliper Rebuild Kit</b> 37.63023 '03-06	<b>Upper Chain Roller</b> 33.0009 '88-06		
				<b>Rear Caliper Rebuild Kit</b> 37.63038 '03-06			
				<b>Front Master Cylinder Rebuild Kit</b> 37.910020 '03-06			
				<b>Rear Master Cylinder Rebuild Kit</b> 37.910003 '03-06			

**ATV-UTV**  
CAN-AM  
GAS GAS  
HONDA  
KAWASAKI  
KTM  
POLARIS  
SUZUKI  
YAMAHA

--	--	--	--	--	--	--	--

**PWC**  
KAWASAKI  
POLARIS  
SEA DOO  
YAMAHA

--	--	--	--	--	--	--	--

**SNOW**  
ARCTIC CAT  
KAWASAKI  
LYNX  
MOTO-SKI  
POLARIS  
SKI DOO  
YAMAHA

--	--	--	--	--	--	--	--

**MOPED & SCOOTER**

--	--	--	--	--	--	--	--

**MISC. TECH. SPECIAL**

--	--	--	--	--	--	--	--



### YAMAHA

**DIRT**  
APRILIA  
BETA  
BMW  
GAS GAS  
HONDA  
HUSABERG  
HUSQVARNA  
KAWASAKI  
KTM  
MOTO TM  
RIEJU  
SHERCO  
SUZUKI  
YAMAHA

<b>YFM 250 R Raptor</b> 4-Stroke Please Note: Nicasil Piston Size -Std. Compression 9.5:1	<b>Piston kit</b> -	<b>Size</b> 74.00	<b>Ring Set</b> -		<b>Con. Rod Kit</b> 03.2308 '08-13	<b>Complete</b> 34.2358 '08-13  <b>Top-End</b> 35.2358 '08-13	<b>Cam Chain</b> 31.1323 '08-13	<b>Valve Seal</b> 35.VS015 '08-13 2x
---	------------------------	----------------------	----------------------	--	--	---	---------------------------------------	--

**STREET**  
APRILIA  
CAGIVA  
HONDA  
KAWASAKI  
KTM  
SUZUKI  
YAMAHA

<b>YFZ 350 Banshee</b> 2-Stroke -Molycoated Skirt	<b>Piston Kit</b> 01.2020.000 01.2020.025 01.2020.050 01.2020.075 01.2020.100 01.2020.125 01.2020.150 01.2020.175 01.2020.200 01.2020.225 01.2020.250 '87-06	<b>Size</b> 64.00 64.25 64.50 64.75 65.00 65.25 65.50 65.75 66.00 66.25 66.50 '87-06	<b>Ring Set</b> 02.2020.000 02.2020.025 02.2020.050 02.2020.075 02.2020.100 02.2020.125 02.2020.150 02.2020.175 02.2020.200 02.2020.250 '87-06	<b>Crank Bearing &amp; Seal Kit</b> 23.CBS23087 '87-06  <b>Bearing</b> 23.83464A '87-06 3x Left, Inner 1+2 23.83406 '87-06 1x Right  <b>Oilseal Set</b> 42.2020 '87-06	<b>Con. Rod Kit</b> 03.2021 '87-06 or 03.2021F '87-06  <b>S/E Bearing</b> 21.2020 '87-06  <b>B/E Bearing</b> 22.222917 '87-06 or 22.222917F '87-06	<b>Complete</b> 34.2021 '87-06  <b>Top-End</b> 35.2019 '87-06		
---	--	--	---	--	--	---	--	--

**PWC**  
KAWASAKI  
POLARIS  
SEA DOO  
YAMAHA

**SNOW**  
ARCTIC CAT  
KAWASAKI  
LYNX  
MOTO-SKI  
POLARIS  
SKI DOO  
YAMAHA

**MOPED & SCOOTER**

**MISC. TECH. SPECIAL**

Footnotes: \* Bearings Only

<b>Air Filter</b> 52.23008 '08-13	<b>Spring Kit</b> 17.CS22031 '08-13	<b>Complete Plate Set</b> 16.CPS23009 '08-13	<b>F/W Bearing</b> 23.S110044 '08-13 2x	<b>Frontbrake Disc</b> 37.BD12409 '08-13 2x	<b>Front Sprocket</b> 07.FS23008-13 07.FS23008-14 '08-13	<b>Swingarm</b> 26.210187 '08-13	<b>Lower A-Arm</b> 26.510009 '08-13
<b>Main Jet</b> 47.221110-170 '08-13 Mikuni	<b>Cover Gasket</b> 19.G2308 '08-13	<b>Friction Set</b> 16.S23050 '08-13	<b>R/W Bearing</b> 23.S115008 '08-13	<b>Rearbrake Disc</b> 37.BD22208 '08-13	<b>Steel Rear Sprocket</b> 07.RS24004-38 07.RS24004-39 07.RS24004-40 '08-13		
<b>Pilot Jet</b> 49.010-045 '08-13 Mikuni	<b>Clutch Cable</b> 53.120064 '08-13	<b>Friction Set</b> 16.S23051 '08-13		<b>Front Pad Set</b> 37.255102 '08-13 Left 37.255102BX '08-13 Box of 10	<b>Chain</b> 07.RC520120C '08-13 MX 07.RC520120CG '08-13 MX Gold 07.RC520120XC '08-13 X-Ring 07.RC520120XCG '08-13 X-Ring Gold		
<b>Oil Filter</b> 54.23140 '08-13 1-Pce. 54.23140-50 '08-13 50-Pcs.				<b>Rear Pad Set</b> 37.200802 '08-13 37.200802BX '08-13 Box of 10			
				<b>Front Caliper Rebuild Kit</b> 37.63027 '08-13			
				<b>Rear Caliper Rebuild Kit</b> 37.63038 '08-13			
				<b>Front Master Cylinder Rebuild Kit</b> 37.910007 '08-13			
				<b>Rear Master Cylinder Rebuild Kit</b> 37.910007 '08-13			

**DIRT**  
APRILIA  
BETA  
BMW  
GAS GAS  
HONDA  
HUSABERG  
HUSQVARNA  
KAWASAKI  
KTM  
MOTO TM  
RIEJU  
SHERCO  
SUZUKI  
YAMAHA

**STREET**  
APRILIA  
CAGIVA  
HONDA  
KAWASAKI  
KTM  
SUZUKI  
YAMAHA

**ATV-UTV**  
CAN-AM  
GAS GAS  
HONDA  
KAWASAKI  
KTM  
POLARIS  
SUZUKI  
YAMAHA

<b>Air Filter</b> 52.23087 '87-06	<b>Basket</b> 17.2020 '87-06	<b>Complete Plate Set</b> 16.CPS23087 '87-06	<b>F/W Bearing</b> 23.S110044 '87-06 2x	<b>Frontbrake Disc</b> 37.BD12409 '90-06 2x	<b>Front Sprocket</b> 07.FS23080-13 07.FS23080-14 07.FS23080-15 '87-06	<b>Swingarm</b> 26.210028 '87-06	<b>Lower A-Arm</b> 26.510009 '87-06	<b>Rear Shock Seal Head Kit</b> 26.810118 '87-06
<b>Main Jet</b> 47.090-580 '87-06 Mikuni	<b>Spring Kit</b> 17.CS24037 '87-06	<b>Friction Set</b> 16.S23026 '87-06	<b>R/W Bearing</b> 23.S113015 '87-88 23.S113013 '89-06	<b>Rearbrake Disc</b> 37.BD22602 '87-89 + '02-06	<b>Chain</b> 07.RC520120C '87-06 MX 07.RC520120CG '87-06 MX Gold 07.RC520120XC '87-06 X-Ring 07.RC520120XCG '87-06 X-Ring Gold	<b>Linkage</b> 26.110002 '87-06	<b>Upper A-Arm</b> 26.510008 '87-90	
<b>Carburetor Rebuild Kit</b> 55.10383 '87-06	<b>Cover Gasket</b> 19.G2387 '87-06	<b>Steel Set</b> 16.S23027 '87-06		<b>Front Pad Set</b> 37.202002 '87-06 37.202002BX '87-06 Box of 10	<b>Lower</b> 26.450027 '87-06	<b>Upper</b> 26.310020 '87-06		
<b>Water Pump Rebuild Kit</b> 57.2317 '87-06	<b>Clutch Cable</b> 53.121018 '87-06			<b>Rear Pad Set</b> 37.200802 '87-06 37.200802BX '87-06 Box of 10	<b>Lower Chain Roller</b> 33.0007 '87-06			
				<b>Front Caliper Rebuild Kit</b> 37.63023 '90-06	<b>Upper Chain Roller</b> 33.0007 '87-06			
				<b>Rear Caliper Rebuild Kit</b> 37.63038 '87-06	<b>Countershaft Seal Kit</b> 26.640032 '87-06			
				<b>Front Master Cylinder Rebuild Kit</b> 37.910020 '87 37.910012 '88-01 37.910020 '02-06				
				<b>Rear Master Cylinder Rebuild Kit</b> 37.910007 '87-06				

**PWC**  
KAWASAKI  
POLARIS  
SEA DOO  
YAMAHA

**SNOW**  
ARCTIC CAT  
KAWASAKI  
LYNX  
MOTO-SKI  
POLARIS  
SKI DOO  
YAMAHA

**MOPED & SCOOTER**

**MISC. TECH. SPECIAL**



### YAMAHA

**DIRT**  
APRILIA  
BETA  
BMW  
GAS GAS  
HONDA  
HUSABERG  
HUSQVARNA  
KAWASAKI  
KTM  
MOTO TM  
RIEJU  
SHERCO  
SUZUKI  
YAMAHA

<b>YFM 350 Warrior</b> 4-Stroke -Std. Compression 9.2:1	<b>Piston kit</b> 01.2487.000 01.2487.050 01.2487.100 '87-04	<b>Size</b> 83.00 83.50 84.00	<b>Ring Set</b> 02.2487.000 02.2487.050 02.2487.100 '87-04	<b>Crank Bearing &amp; Seal Kit</b> 23.CBS23086 '87-04	<b>Con. Rod Kit</b> 03.2487 '87-04	<b>Complete</b> 34.2487 '87-04	<b>Cam Chain</b> 31.2487 '87-04	<b>Valve</b> 28.2487-1 '87-04 1x Exhaust Steel 28.2487-2 '87-04 1x Intake Steel  <b>Valve Seal</b> 35.VS016 '87-04 2x
				<b>Bearing</b> 23.6306YA1C4 '87-04 2x	<b>Crankpin</b> 06.3357.8 '87-04	<b>Top-End</b> 35.2160 '87-04		

**STREET**  
APRILIA  
CAGIVA  
HONDA  
KAWASAKI  
KTM  
SUZUKI  
YAMAHA

--	--	--	--	--	--	--	--	--

**ATV-UTV**  
CAN-AM  
GAS GAS  
HONDA  
KAWASAKI  
KTM  
POLARIS  
SUZUKI  
YAMAHA

--	--	--	--	--	--	--	--	--

**PWC**  
KAWASAKI  
POLARIS  
SEA DOO  
YAMAHA

<b>YFM 350 R Raptor</b> 4-Stroke -Std. Compression 9.2:1	<b>Piston kit</b> 01.2487.000 01.2487.050 01.2487.100 '05-13	<b>Size</b> 83.00 83.50 84.00	<b>Ring Set</b> 02.2487.000 02.2487.050 02.2487.100 '05-13	<b>Crank Bearing &amp; Seal Kit</b> 23.CBS23086 '05-13	<b>Con. Rod Kit</b> 03.2487 '05-13	<b>Complete</b> 34.2487 '05-13	<b>Cam Chain</b> 31.2487 '05-13	<b>Valve</b> 28.2487-1 '05-13 1x Exhaust Steel 28.2487-2 '05-13 1x Intake Steel  <b>Valve Seal</b> 35.VS017 '05-13 2x
				<b>Bearing</b> 23.6306YA1C4 '05-13 2x	<b>Crankpin</b> 06.3357.8 '05-13	<b>Top-End</b> 35.2160 '05-13		

**SNOW**  
ARCTIC CAT  
KAWASAKI  
LYNX  
MOTO-SKI  
POLARIS  
SKI DOO  
YAMAHA

--	--	--	--	--	--	--	--	--

**MOPED & SCOOTER**

--	--	--	--	--	--	--	--	--

**MISC. TECH. SPECIAL**

--	--	--	--	--	--	--	--	--

Footnotes: \* Bearings Only

<b>Air Filter</b> 52.24087 '87-04	<b>Spring Kit</b> 17.CS22031 '87-04	<b>Complete Plate Set</b> 16.CPS23088 '87-04	<b>F/W Bearing</b> 23.S110044 '87-04 2x	<b>Frontbrake Disc</b> 37.BD12409 '89-04 2x	<b>Front Sprocket</b> 07.FS23080-13 07.FS23080-14 07.FS23080-15 '87-04	<b>Swingarm</b> 26.210027 '87-04	<b>Lower A-Arm</b> 26.510009 '89-04	<b>Rear Shock Seal Head Kit</b> 26.810118 '87-04
<b>Oil Filter</b> 54.23142 '89-04 1-Pce. 54.23142-50 '89-04 50-Pcs.		<b>Friction Set</b> 16.S23048 '87-04	<b>R/W Bearing</b> 23.S113029 '87-04	<b>Rearbrake Disc</b> 37.BD22602 '88-89	<b>Chain</b> 07.RC520120C '87-04 MX 07.RC520120CG '87-04 MX Gold 07.RC520120XC '87-04 X-Ring 07.RC520120XCG '87-04 X-Ring Gold	<b>Linkage</b> 26.110002 '87-04	<b>Upper A-Arm</b> 26.510009 '87-04	
		<b>Steel Set</b> 16.S23064 '87-04		<b>Front Pad Set</b> 37.202002 '89-04 37.202002BX '89-04 Box of 10	<b>Lower Chain Roller</b> 33.0009 '87-04	<b>Lower</b> 26.450027 '87-04		
				<b>Rear Pad Set</b> 37.200802 '89-04 37.200802BX '89-04 Box of 10	<b>Upper Chain Roller</b> 33.0009 '87-04	<b>Upper</b> 26.310020 '87-04		
				<b>Front Caliper Rebuild Kit</b> 37.63023 '90-04	<b>Countershaft Seal Kit</b> 26.640033 '87-04			
				<b>Rear Caliper Rebuild Kit</b> 37.63038 '87-04				
				<b>Front Master Cylinder Rebuild Kit</b> 37.910012 '88-01 37.910020 '02-04				
				<b>Rear Master Cylinder Rebuild Kit</b> 37.910007 '87-89 37.910003 '90-04				

**DIRT**  
APRILIA  
BETA  
BMW  
GAS GAS  
HONDA  
HUSABERG  
HUSQVARNA  
KAWASAKI  
KTM  
MOTO TM  
RIEJU  
SHERCO  
SUZUKI  
YAMAHA

**STREET**  
APRILIA  
CAGIVA  
HONDA  
KAWASAKI  
KTM  
SUZUKI  
YAMAHA

**ATV-UTV**  
CAN-AM  
GAS GAS  
HONDA  
KAWASAKI  
KTM  
POLARIS  
SUZUKI  
YAMAHA

**PWC**  
KAWASAKI  
POLARIS  
SEA DOO  
YAMAHA

**SNOW**  
ARCTIC CAT  
KAWASAKI  
LYNX  
MOTO-SKI  
POLARIS  
SKI DOO  
YAMAHA

**MOPED & SCOOTER**

**MISC. TECH. SPECIAL**



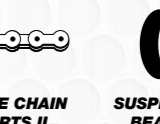

### YAMAHA

**DIRT**  
APRILIA  
BETA  
BMW  
GAS GAS  
HONDA  
HUSABERG  
HUSQVARNA  
KAWASAKI  
KTM  
MOTO TM  
RIEJU  
SHERCO  
SUZUKI  
YAMAHA

<b>YFM 350 Bruin</b> 4-Stroke -Std. Compression 9.2:1	<b>Piston kit</b> 01.2487.000 01.2487.050 01.2487.100 '04-06	<b>Size</b> 83.00 83.50 84.00	<b>Ring Set</b> 02.2487.000 02.2487.050 02.2487.100 '04-06			<b>Complete</b> 34.2488 '04-06	<b>Cam Chain</b> 31.2404 '04-06	<b>Valve</b> 28.2487-1 '04-06 1x Exhaust Steel 28.2487-2 '04-06 1x Intake Steel <b>Valve Seal</b> 35.VS017 '04-06 2x
---	--	--	--	--	--	--------------------------------------	---------------------------------------	---

**STREET**  
APRILIA  
CAGIVA  
HONDA  
KAWASAKI  
KTM  
SUZUKI  
YAMAHA

<b>YFM 350 Grizzly</b> 4-Stroke -Std. Compression 9.2:1	<b>Piston kit</b> 01.2487.000 01.2487.050 01.2487.100 '07-14	<b>Size</b> 83.00 83.50 84.00	<b>Ring Set</b> 02.2487.000 02.2487.050 02.2487.100 '07-14			<b>Complete</b> 34.2488 '07-14	<b>Cam Chain</b> 31.2404 '07-14	<b>Valve</b> 28.2487-1 '07-14 1x Exhaust Steel 28.2487-2 '07-14 1x Intake Steel <b>Valve Seal</b> 35.VS017 '07-14 2x
---	--	--	--	--	--	--------------------------------------	---------------------------------------	---

**ATV-UTV**  
CAN-AM  
GAS GAS  
HONDA  
KAWASAKI  
KTM  
POLARIS  
SUZUKI  
YAMAHA

<b>YFM 350 Wolverine</b> 4-Stroke	<b>Piston kit</b> -	<b>Size</b> 83.00	<b>Ring Set</b> -			<b>Top-End</b> 35.2160 '95-09	<b>Cam Chain</b> 31.2487 '95-05 31.2404 '06-09	<b>Valve Seal</b> 35.VS017 '95-09 2x
--------------------------------------	------------------------	----------------------	----------------------	--	--	-------------------------------------	--	--

**PWC**  
KAWASAKI  
POLARIS  
SEA DOO  
YAMAHA

**SNOW**  
ARCTIC CAT  
KAWASAKI  
LYNX  
MOTO-SKI  
POLARIS  
SKI DOO  
YAMAHA

**MOPED & SCOOTER**

<b>YFM 400 Big Bear</b> 4-Stroke	<b>Piston kit</b> -	<b>Size</b> 83.00	<b>Ring Set</b> -			<b>Top-End</b> 35.2160 '00-12		
-------------------------------------	------------------------	----------------------	----------------------	--	--	-------------------------------------	--	--

Footnotes: \* Bearings Only

**DIRT**  
APRILIA  
BETA  
BMW  
GAS GAS  
HONDA  
HUSABERG  
HUSQVARNA  
KAWASAKI  
KTM  
MOTO TM  
RIEJU  
SHERCO  
SUZUKI  
YAMAHA

**STREET**  
APRILIA  
CAGIVA  
HONDA  
KAWASAKI  
KTM  
SUZUKI  
YAMAHA

**ATV-UTV**  
CAN-AM  
GAS GAS  
HONDA  
KAWASAKI  
KTM  
POLARIS  
SUZUKI  
YAMAHA

**PWC**  
KAWASAKI  
POLARIS  
SEA DOO  
YAMAHA

**SNOW**  
ARCTIC CAT  
KAWASAKI  
LYNX  
MOTO-SKI  
POLARIS  
SKI DOO  
YAMAHA

**MOPED & SCOOTER**

**MISC. TECH. SPECIAL**

			<b>F/W Bearing</b> 23.S111008 '04-06 2x	<b>Front Pad Set</b> 37.202002 '04-06 37.202002BX '04-06 Box of 10				
			<b>R/W Bearing</b> 23.S111039 '04-06	<b>Front Caliper Rebuild Kit</b> 37.63023 '04-06				
				<b>Front Master Cylinder Rebuild Kit</b> 37.910021 '04-06				
<b>Main Jet</b> 47.221110-170 '07-14 Mikuni			<b>F/W Bearing</b> 23.S111008 '07-14 2x	<b>Front Pad Set</b> 37.202002 '07-14 37.202002BX '07-14 Box of 10				
<b>Pilot Jet</b> 49.010-045 '07-14 Mikuni			<b>R/W Bearing</b> 23.S114096 '07-11 2x 23.S111039 '12-14 2x	<b>Front Caliper Rebuild Kit</b> 37.63023 '07-14				
				<b>Front Master Cylinder Rebuild Kit</b> 37.910021 '07-14				
<b>Air Filter</b> 52.24087 '95-09			<b>F/W Bearing</b> 23.S111008 '95-09 2x	<b>Rearbrake Disc</b> 37.BD22602 '95-06			<b>Swingarm</b> 26.210058 '95-05	
<b>Oil Filter</b> 54.23142 '95-05 1-Pce. 54.23142-50 '95-05 50-Pcs.			<b>R/W Bearing</b> 23.S110017 '95-99 23.S110018 '00-05 23.S111039 '06-09	<b>Front Pad Set</b> 37.202002 '95-09 37.202002BX '95-09 Box of 10				
				<b>Rear Pad Set</b> 37.200802 '95-05 37.200802BX '95-05 Box of 10				
				<b>Front Caliper Rebuild Kit</b> 37.63023 '95-09				
				<b>Rear Caliper Rebuild Kit</b> 37.63038 '95-05				
				<b>Front Master Cylinder Rebuild Kit</b> 37.910012 '95-01 37.910021 '02-09				
				<b>Rear Master Cylinder Rebuild Kit</b> 37.910003 '95-05				
<b>Oil Filter</b> 54.23142 '00-12 1-Pce. 54.23142-50 '00-12 50-Pcs.			<b>F/W Bearing</b> 23.S111008 '00-12 2x	<b>Front Master Cylinder Rebuild Kit</b> 37.910012 '00-01 37.910021 '02-12				
			<b>R/W Bearing</b> 23.S111039 '00-06 23.S114096 '07-12	<b>Front Caliper Rebuild Kit</b> 37.63023 '00-12				

**MISC. TECH. SPECIAL**





### YAMAHA

<b>DIRT</b> APRILIA BETA BMW GAS GAS HONDA HUSABERG HUSQVARNA KAWASAKI KTM MOTO TM RIEJU SHERCO SUZUKI YAMAHA	<b>YFZ 450</b> 4-Stroke Please Note: Nicasil Piston Size -Std. Comp. 12.0:1 '04-09 -Std. Comp. 11.4:1 '12-13 -Forged Piston	<b>Piston Kit</b> 01.2435.A 01.2435.B 01.2435.C '04-13	<b>Sizes (mm)</b> 94.95 94.96 94.97	<b>Ring Set</b> 02.6419 02.6419 02.6419 '04-13	<b>Crank Bearing &amp; Seal Kit</b> 23.CBS24098* '04-13	<b>Con. Rod Kit</b> 03.2434 '04-05 03.2436 '06-09	<b>Complete</b> 34.2434 '04-13	<b>Cam Chain</b> 31.2423 '04-13	<b>Valve</b> 28.2423-1 '04-09 2x Exhaust Titanium 28.2423-2 '04-09 1x Intake Titanium 28.2423-3 '04-09 2x Intake Titanium
	Please Note: Nicasil Piston Size -High Comp. 13.0:1 '04-09 -High Comp. 12.4:1 '12-13 -Forged Piston	<b>High Compression</b> 01.2436.A 01.2436.B '04-13	<b>Size</b> 94.95 94.96	<b>Ring Set</b> 02.6419 02.6419 '04-13	<b>Bearing</b> 23.83C072C '04-13 2x	<b>Top-End</b> 35.2434 '04-13	<b>Valve Shim Assortment</b> 29.VSA948 '04-13 29.VSA948-2 '04-13	<b>TI-Steel Conversion Set</b> 28.SES2424-1 '04-09 Exhaust 28.SIS2424-2 '04-09 Intake	<b>Valve Seal</b> 35.VS012 '04-13 3x Int. 35.VS013 '04-13 2x Exh.
<b>STREET</b> APRILIA CAGIVA HONDA KAWASAKI KTM SUZUKI YAMAHA				<b>Clips</b> 05.2012 '04-13					
<b>ATV-UTV</b> CAN-AM GAS GAS HONDA KAWASAKI KTM POLARIS SUZUKI YAMAHA									
<b>PWC</b> KAWASAKI POLARIS SEA DOO YAMAHA									
<b>SNOW</b> ARCTIC CAT KAWASAKI LYNX MOTO-SKI POLARIS SKI DOO YAMAHA									
<b>MOPED &amp; SCOOTER</b>									
<b>MISC. TECH. SPECIAL</b>									

Footnotes: \* Bearings Only

<b>Air Filter</b> 52.24004 '04-13	<b>Basket</b> 17.2434F '04-06 17.2437F '07-13	<b>Complete Plate Set</b> 16.CPS24004 '04-06	<b>F/W Bearing</b> 23.S110044 '04-13 2x	<b>Frontbrake Disc</b> 37.BD12409 '04-14 2x	<b>Front Sprocket</b> 07.FS23099-13 07.FS23099-14 07.FS23099-15 '04-13	<b>Swingarm</b> 26.210114 '04-13	<b>Lower A-Arm</b> 26.510009 '04-13	<b>Rear Shock Seal Head Kit</b> 26.810012 '04-13 Front 26.810010 '04-13 Rear
<b>Main Jet</b> 45.100-225 '04-09 Keihin 47.221110-170 '12-13 Mikuni	<b>Spring Kit</b> 17.CS24038 '04-06 17.CS24039 '07-09	<b>Friction Set</b> 16.CPS24008 '07 16.CPS24012 '08-09 16.CPS24012 '12-13	<b>R/W Bearing</b> 23.S114056 '04-05 23.S115026 '06-09 23.S116018 '12-13	<b>Rearbrake Disc</b> 37.BD22208 '04-05 37.BD22409 '06-14	<b>Steel Rear Sprocket</b> 07.RS24004-38 07.RS24004-39 07.RS24004-40 '04-13	<b>Linkage</b> 26.110116 '04-05 26.110139 '06-13	<b>Lower</b> 26.450043 '04-13	
<b>Pilot Jet</b> 46.040-085 '04-09 Keihin 49.010-045 '12-13 Mikuni	<b>Cover Gasket</b> 17.CS23033 '12-13 19.G2423 '07-09	<b>Clutch Cable</b> 16.S24028 '04-06 16.S24031 '07 16.S24052 '08-09 16.S26030 '12-13	<b>Front Pad Set</b> 37.100202 '04-09 Left 37.100202BX '04-09 Box of 10 37.204302 '04-09 Right 37.204302BX '04-09 Box of 10 37.200802 '12-13 2x 37.200802BX '12-13 Box of 10	<b>Chain</b> 07.RC520120C '04-13 MX 07.RC520120CG '04-13 MX Gold 07.RC520120XC '04-13 X-Ring 07.RC520120XCG '04-13 X-Ring Gold	<b>Lower Chain Roller</b> 37.200802 '04-05 37.200802BX '04-05 Box of 10 37.208002 '06-13 37.208002BX '06-13 Box of 10	<b>Upper Chain Roller</b> 33.0008 '04-13	<b>Countershaft Seal Kit</b> 26.640019 '04-13	
<b>Oil Filter</b> 54.23140 '04-13 1-Pce. 54.23140-50 '04-13 50-Pcs.	<b>Water Pump Rebuild Kit</b> 57.2425 '04-13	<b>Steel Set</b> 16.S23016 '04-13	<b>Rear Pad Set</b> 37.200802 '04-05 37.200802BX '04-05 Box of 10 37.208002 '06-13 37.208002BX '06-13 Box of 10	<b>Rear Caliper Rebuild Kit</b> 37.63045 '04-09 37.63023 '12-13	<b>Rear Master Cylinder Rebuild Kit</b> 37.910020 '04-06 37.910004 '07-13	<b>Rear Master Cylinder Rebuild Kit</b> 37.910007 '04-13		

<b>DIRT</b> APRILIA BETA BMW GAS GAS HONDA HUSABERG HUSQVARNA KAWASAKI KTM MOTO TM RIEJU SHERCO SUZUKI YAMAHA	
<b>STREET</b> APRILIA CAGIVA HONDA KAWASAKI KTM SUZUKI YAMAHA	
<b>ATV-UTV</b> CAN-AM GAS GAS HONDA KAWASAKI KTM POLARIS SUZUKI YAMAHA	
<b>PWC</b> KAWASAKI POLARIS SEA DOO YAMAHA	
<b>SNOW</b> ARCTIC CAT KAWASAKI LYNX MOTO-SKI POLARIS SKI DOO YAMAHA	
<b>MOPED &amp; SCOOTER</b>	
<b>MISC. TECH. SPECIAL</b>	



### YAMAHA

**DIRT**  
 APRILIA  
 BETA  
 BMW  
 GAS GAS  
 HONDA  
 HUSABERG  
 HUSQVARNA  
 KAWASAKI  
 KTM  
 MOTO TM  
 RIEJU  
 SHERCO  
 SUZUKI  
 YAMAHA

<b>YFZ 450 R</b> 4-Stroke Please Note: Nicasil Piston Size -Std. Compression 11.6:1 -Forged Piston -Fuel Injection	<b>Piston kit</b> 01.2435.A 01.2435.B 01.2435.C '09-23	<b>Size</b> 94.95 94.96 94.97	<b>Ring Set</b> 02.6419 02.6419 02.6419 '09-23	<b>Crank Bearing &amp; Seal Kit</b> 23.CBS24009* '09-23	<b>Con. Rod Kit</b> 03.2439 '09-13 03.2444 '14-23	<b>Complete</b> 34.2439 '09-23	<b>Cam Chain</b> 31.2429 '09-23	<b>Valve</b> 28.2423-1 '09-23 2x Exhaust Titanium 28.2423-2 '09-23 1x Intake Titanium 28.2423-3 '09-23 2x Intake Titanium
Please Note: Nicasil Piston Size -High Compression 12.6:1 -Forged Piston -Fuel Injection	<b>High Compression</b> 01.2436.A 01.2436.B '09-23	<b>Size</b> 94.95 94.96	<b>Ring Set</b> 02.6419 02.6419 '09-23	<b>Bearing</b> 23.SX06C84 '09-23 2x	<b>B/E Bearing</b> 22.364523F-1 '09-23	<b>Top-End</b> 35.2439 '09-23	<b>Valve Shim Assortment</b> 29.VSA948 '09-23	<b>TI-Steel Conversion Set</b> 28.SES2424-1 '09-23 Exhaust 28.SIS2424-2 '09-23 Intake
			<b>Clips</b> 05.2012 '09-23					<b>Valve Seal</b> 35.VS012 '09-23 3x Intake 35.VS013 '09-23 2x Exhaust

**STREET**  
 APRILIA  
 CAGIVA  
 HONDA  
 KAWASAKI  
 KTM  
 SUZUKI  
 YAMAHA

**ATV-UTV**  
 CAN-AM  
 GAS GAS  
 HONDA  
 KAWASAKI  
 KTM  
 POLARIS  
 SUZUKI  
 YAMAHA

**PWC**  
 KAWASAKI  
 POLARIS  
 SEA DOO  
 YAMAHA

**SNOW**  
 ARCTIC CAT  
 KAWASAKI  
 LYNX  
 MOTO-SKI  
 POLARIS  
 SKI DOO  
 YAMAHA

**MOPED & SCOOTER**

**MISC. TECH. SPECIAL**

Footnotes: \* Bearings Only

<b>Air Filter</b> 52.24004 '09-23	<b>Spring Kit</b> 17.CS24039 '09-13	<b>Complete Plate Set</b> 16.CPS24009 '09-13	<b>F/W Bearing</b> 23.S110044 '09-23 2x	<b>Frontbrake Disc</b> 37.BD12409 '09-23 2x	<b>Front Sprocket</b> 07.FS27006-13 07.FS27006-14 07.FS27006-15 '09-23	<b>Swingarm</b> 26.210200 '09-23	<b>Lower A-Arm</b> 26.510009 '09-17
<b>Throttle Cable</b> 53.111092 '09-23	<b>Cover Gasket</b> 19.G2423 '09-23	<b>Friction Set</b> 16.S24056 '09-13	<b>R/W Bearing</b> 23.S116012 '09-23	<b>Rearbrake Disc</b> 37.BD22409 '09-23	<b>Steel Rear Sprocket</b> 07.RS24004-38 07.RS24004-39 07.RS24004-40 '09-23	<b>Linkage</b> 26.110175 '09-23	<b>Upper A-Arm</b> 26.510058 '09-17
<b>Oil Filter</b> 54.23140 '09-23 1-Pce. 54.23140-50 '09-23 50-Pcs.	<b>Clutch Cable</b> 53.120060 '09-23	<b>16.S24059</b> '14-23	<b>OEM R/W Bearing</b> 23.DDG4064-2RS '09-23 2x	<b>Front Pad Set</b> 37.100202 '09-23 Left 37.100202BX '09-23 Box of 10 37.204302 '09-23 Right 37.204302BX '09-23 Box of 10	<b>Chain</b> 07.RC520120C '09-23 MX 07.RC520120CG '09-23 MX Gold 07.RC520120XC '09-23 X-Ring 07.RC520120XCG '09-23 X-Ring Gold	<b>Lower</b> 26.450043 '09-23	
<b>Water Pump Rebuild Kit</b> 57.2429 '09-23		<b>Steel Set</b> 16.S23016 '09-13		<b>Rear Pad Set</b> 37.208002 '09-23 37.208002BX '09-23 Box of 10	<b>Lower Chain Roller</b> 33.0008 '09-23		
				<b>Rear Caliper Rebuild Kit</b> 37.63045 '09-23	<b>Countershaft Seal Kit</b> 26.640031 '09-23		
				<b>Front Master Cylinder Rebuild Kit</b> 37.910004 '09-23			
				<b>Rear Master Cylinder Rebuild Kit</b> 37.910007 '09-23			

**DIRT**  
 APRILIA  
 BETA  
 BMW  
 GAS GAS  
 HONDA  
 HUSABERG  
 HUSQVARNA  
 KAWASAKI  
 KTM  
 MOTO TM  
 RIEJU  
 SHERCO  
 SUZUKI  
 YAMAHA

**STREET**  
 APRILIA  
 CAGIVA  
 HONDA  
 KAWASAKI  
 KTM  
 SUZUKI  
 YAMAHA

**ATV-UTV**  
 CAN-AM  
 GAS GAS  
 HONDA  
 KAWASAKI  
 KTM  
 POLARIS  
 SUZUKI  
 YAMAHA

**PWC**  
 KAWASAKI  
 POLARIS  
 SEA DOO  
 YAMAHA

**SNOW**  
 ARCTIC CAT  
 KAWASAKI  
 LYNX  
 MOTO-SKI  
 POLARIS  
 SKI DOO  
 YAMAHA

**MOPED & SCOOTER**

**MISC. TECH. SPECIAL**



### YAMAHA

**DIRT**  
APRILIA  
BETA  
BMW  
GAS GAS  
HONDA  
HUSABERG  
HUSQVARNA  
KAWASAKI  
KTM  
MOTO TM  
RIEJU  
SHERCO  
SUZUKI  
YAMAHA

<b>YFM 660 Raptor</b> 4-Stroke -Std. Compression 9.2:1	<b>Piston kit</b> 01.2660.000 01.2660.050 01.2660.100 '01-05	<b>Size</b> 100.00 100.50 101.00	<b>Ring Set</b> 02.2660.000 02.2660.050 02.2660.100 '01-05	<b>Bearing</b> 23.6307 '01-05 2x	<b>Con. Rod Kit</b> 03.2661 '01-05	<b>Complete</b> 34.2662 '01-05	<b>Cam Chain</b> 31.2661 '01-05	<b>Valve</b> 28.2661-1 '01-05 2x Exhaust Steel 28.2661-2 '01-05 3x Intake Steel  <b>Valve Seal</b> 35.VS015 '01-05 5x
			<b>Pin</b> 04.2270 '01-05		<b>Crankpin</b> 06.3773.8-2 '02-05	<b>Top-End</b> 35.2662 '01-05		
			<b>Clips</b> 05.2214 '01-05					

**STREET**  
APRILIA  
CAGIVA  
HONDA  
KAWASAKI  
KTM  
SUZUKI  
YAMAHA

<b>YFM 660 F Grizzly</b> 4-Stroke -Std. Compression 9.1:1	<b>Piston kit</b> 01.2660.000 01.2660.050 01.2660.100 '02-06	<b>Size</b> 100.00 100.50 101.00	<b>Ring Set</b> 02.2660.000 02.2660.050 02.2660.100 '02-06	<b>Bearing</b> 23.6307 '02-08 2x	<b>Con. Rod Kit</b> 03.2661 '02-08	<b>Complete</b> 34.2661 '02-08	<b>Cam Chain</b> 31.1331 '02-08	<b>Valve</b> 28.2661-1 '02-08 2x Exhaust Steel 28.2661-2 '02-08 3x Intake Steel  <b>Valve Seal</b> 35.VS015 '02-08 5x
			<b>Pin</b> 04.2270 '02-08		<b>B/E Bearing</b> 22.374522F '02-08	<b>Top-End</b> 35.2661 '02-08		
			<b>Clips</b> 05.2214 '02-08		<b>Crankpin</b> 06.3773.8-2 '02-08			

**PWC**  
KAWASAKI  
POLARIS  
SEA DOO  
YAMAHA

<b>YXR 660 Rhino</b> 2004-2007 4-Stroke -Std. Compression 9.1:1	<b>Piston kit</b> 01.2660.000 01.2660.050 01.2660.100	<b>Size</b> 100.00 100.50 101.00	<b>Ring Set</b> 02.2660.000 02.2660.050 02.2660.100	<b>Bearing</b> 23.6307 '04-07 2x	<b>Con. Rod Kit</b> 03.2661 '04-07	<b>Complete</b> 34.2661 '04-07	<b>Cam Chain</b> 31.1331 '04-07	<b>Valve</b> 28.2661-1 '04-07 2x Exhaust Steel 28.2661-2 '04-07 3x Intake Steel  <b>Valve Seal</b> 35.VS015 '04-07 5x
			<b>Pin</b> 04.2270 '04-07		<b>B/E Bearing</b> 22.374522F '04-07	<b>Top-End</b> 35.2661 '04-07		
			<b>Clips</b> 05.2214 '04-07		<b>Crankpin</b> 06.3773.8-2 '04-07			

**MOPED & SCOOTER**

**MISC. TECH. SPECIAL**

Footnotes: \* Bearings Only

<b>Air Filter</b> 52.26001 '01-05	<b>Basket</b> 17.2404F '01-05	<b>Friction Set</b> 16.S26029 '01-05	<b>F/W Bearing</b> 23.S110044 '01-05 2x	<b>Frontbrake Disc</b> 37.BD12409 '02-05 2x	<b>Front Sprocket</b> 07.FS23099-13 07.FS23099-14 07.FS23099-15 '01-05	<b>Swingarm</b> 26.210097 '01-05	<b>Lower A-Arm</b> 26.510009 '01-05	<b>Rear Shock Seal Head Kit</b> 26.810118 '01-05
<b>Main Jet</b> 47.221110-170 '01-05 Mikuni	<b>Spring Kit</b> 17.CS22031 '01-05		<b>R/W Bearing</b> 23.S113013 '01-05	<b>Rearbrake Disc</b> 37.BD22602 '02-05	<b>Chain</b> 07.RC520120C '01-05 MX 07.RC520120CG '01-05 MX Gold 07.RC520120XC '01-05 X-Ring 07.RC520120XCG '01-05 X-Ring Gold	<b>Linkage</b> 26.110096 '01-05	<b>Lower</b> 26.450027 '01-05	
<b>Pilot Jet</b> 49.010-045 '01-05 Mikuni	<b>Cover Gasket</b> 19.G2661 '01-05			<b>Front Pad Set</b> 37.200802 '01-05		<b>Upper Chain Roller</b> 33.0007 '01-05		
<b>Water Pump Rebuild Kit</b> 57.2621 '01-05				<b>37.200802BX</b> '01-05 Box of 10		<b>Upper</b> 26.310020 '01-05		
				<b>Rear Pad Set</b> 37.200802 '01-05				
				<b>37.200802BX</b> '01-05 Box of 10				
				<b>Front Caliper Rebuild Kit</b> 37.63023 '01-05				
				<b>Rear Caliper Rebuild Kit</b> 37.63038 '01-05				
				<b>Front Master Cylinder Rebuild Kit</b> 37.910020 '01-05				
				<b>Rear Master Cylinder Rebuild Kit</b> 37.910007 '01-05				

**DIRT**  
APRILIA  
BETA  
BMW  
GAS GAS  
HONDA  
HUSABERG  
HUSQVARNA  
KAWASAKI  
KTM  
MOTO TM  
RIEJU  
SHERCO  
SUZUKI  
YAMAHA

**STREET**  
APRILIA  
CAGIVA  
HONDA  
KAWASAKI  
KTM  
SUZUKI  
YAMAHA

**ATV-UTV**  
CAN-AM  
GAS GAS  
HONDA  
KAWASAKI  
KTM  
POLARIS  
SUZUKI  
YAMAHA

**PWC**  
KAWASAKI  
POLARIS  
SEA DOO  
YAMAHA

**SNOW**  
ARCTIC CAT  
KAWASAKI  
LYNX  
MOTO-SKI  
POLARIS  
SKI DOO  
YAMAHA

**MOPED & SCOOTER**

**MISC. TECH. SPECIAL**





### YAMAHA

**DIRT**  
APRILIA  
BETA  
BMW  
GAS GAS  
HONDA  
HUSABERG  
HUSQVARNA  
KAWASAKI  
KTM  
MOTO TM  
RIEJU  
SHERCO  
SUZUKI  
YAMAHA

**STREET**  
APRILIA  
CAGIVA  
HONDA  
KAWASAKI  
KTM  
SUZUKI  
YAMAHA

**ATV-UTV**  
CAN-AM  
GAS GAS  
HONDA  
KAWASAKI  
KTM  
POLARIS  
SUZUKI  
YAMAHA

**PWC**  
KAWASAKI  
POLARIS  
SEA DOO  
YAMAHA

**SNOW**  
ARCTIC CAT  
KAWASAKI  
LYNX  
MOTO-SKI  
POLARIS  
SKI DOO  
YAMAHA

**MOPED & SCOOTER**

**MISC. TECH. SPECIAL**

YAMAHA	Piston Kit	Size (mm)	Ring Set	Bearing	Con. Rod Kit	Complete	Cam Chain	Valve
<b>YFM 700 R Raptor</b> 4-Stroke Please Note: Nicasil Piston Size -Std. Compression 9.2:1 -Forged Piston -Fuel Injection	01.2706.A 01.2706.B 01.2706.C '06-14	101.94 101.95 101.96	02.6608 02.6608 02.6608 '06-14	23.6308YA3 '06-23 2x	03.2706 '06-23	34.2706 '06-14 34.2715 '15-22	31.2706 '06-23	28.2706-1 '06-23 2x Exhaust Steel 28.2706-2 '06-23 2x Intake Steel
Please Note: Nicasil Piston Size -Std. Compression 10.0:1 -Forged Piston -Fuel Injection	01.2714.A 01.2714.B 01.2714.C '15-23	101.94 101.95 101.96	02.6608 02.6608 02.6608 '15-23		<b>B/E Bearing</b> 22.405022F '06-23	<b>Top-End</b> 35.2706 '06-14 35.2718 '15-23		<b>Valve Seal</b> 35.VS015 '06-23 4x
Please Note: Nicasil Piston Size -High Compression 11.0:1 -Forged Piston -Fuel Injection	<b>High Compression</b> 01.2707.A 01.2707.B '06-14	101.94 101.95	02.6608 02.6608 '06-14	<b>Pin</b> 04.2357.2 '06-23		<b>Head &amp; Base</b> 36.2706 '06-23		
				<b>Clips</b> 05.2318 '06-23				

Footnotes: \* Bearings Only

AIR & FUEL PARTS	CLUTCH PARTS	CLUTCH PLATE SETS	WHEEL & STEERING PARTS	BRAKE PARTS	DRIVE CHAIN PARTS I	DRIVE CHAIN PARTS II	SUSPENSION BEARING KITS	SUSPENSION PARTS
<b>Air Filter</b> 52.27006 '06-23	<b>Spring Kit</b> 17.CS24036 '06-23	<b>Complete Plate Set</b> 16.CPS27006 '06-23	<b>F/W Bearing</b> 23.S110044 '06-23 2x	<b>Frontbrake Disc</b> 37.BD12409 '06-23 2x	<b>Front Sprocket</b> 07.FS27006-13 07.FS27006-14 07.FS27006-15 '06-23	<b>Swingarm</b> 26.210159 '06-23	<b>Lower A-Arm</b> 26.510009 '06-18	<b>Rear Shock Seal Head Kit</b> 26.810118 '06-17
<b>Throttle Cable</b> 53.111091 '06-23	<b>Cover Gasket</b> 19.G2706 '06-23	<b>Friction Set</b> 16.S26030 '06-23	<b>R/W Bearing</b> 23.S115026 '06-12 23.S116018 '13-23	<b>Rearbrake Disc</b> 37.BD22409 '06-23	<b>Steel Rear Sprocket</b> 07.RS24004-38 07.RS24004-39 07.RS24004-40 '06-23	<b>Linkage</b> 26.110140 '06-14 26.110184 '15-23		
<b>Oil Filter</b> 54.27145 '06-23 1-Pce. 54.27145-50 '06-23 50-Pcs.	<b>Clutch Cable</b> 53.120058 '06-23	<b>Steel Set</b> 16.S23016 '06-23	<b>OEM R/W Bearing</b> 23.DDG4064-2RS '13-23 2x	<b>Front Pad Set</b> 37.100202 '06-23 Left 37.100202BX '06-23 Box of 10 37.204302 '06-23 Right 37.204302BX '06-23 Box of 10	<b>Chain</b> 07.RC520120C '06-23 MX 07.RC520120CG '06-23 MX Gold 07.RC520120XC '06-23 X-Ring 07.RC520120XCG '06-23 X-Ring Gold	<b>Upper</b> 26.450043 '06-19	<b>Lower</b> 26.450072 '06-23	
<b>Water Pump Rebuild Kit</b> 57.2726 '06-23				<b>Rear Pad Set</b> 37.226102 '06-12 Rear 37.226102BX '06-12 Box of 10 37.208002 '13-23 Rear 37.208002BX '13-23 Box of 10	<b>Lower Chain Roller</b> 33.0008 '06-15			
				<b>Front Caliper Rebuild Kit</b> 37.63045 '06-23	<b>Countershaft Seal Kit</b> 26.640031 '06-23			
				<b>Rear Caliper Rebuild Kit</b> 37.63041 '06-12 37.63040 '13-23				
				<b>Front Master Cylinder Rebuild Kit</b> 37.910020 '06 37.910004 '07-23				
				<b>Rear Master Cylinder Rebuild Kit</b> 37.910007 '06-23				

**DIRT**  
APRILIA  
BETA  
BMW  
GAS GAS  
HONDA  
HUSABERG  
HUSQVARNA  
KAWASAKI  
KTM  
MOTO TM  
RIEJU  
SHERCO  
SUZUKI  
YAMAHA

**STREET**  
APRILIA  
CAGIVA  
HONDA  
KAWASAKI  
KTM  
SUZUKI  
YAMAHA

**ATV-UTV**  
CAN-AM  
GAS GAS  
HONDA  
KAWASAKI  
KTM  
POLARIS  
SUZUKI  
YAMAHA

**PWC**  
KAWASAKI  
POLARIS  
SEA DOO  
YAMAHA

**SNOW**  
ARCTIC CAT  
KAWASAKI  
LYNX  
MOTO-SKI  
POLARIS  
SKI DOO  
YAMAHA

**MOPED & SCOOTER**

**MISC. TECH. SPECIAL**





### YAMAHA

**DIRT**  
APRILIA  
BETA  
BMW  
GAS GAS  
HONDA  
HUSABERG  
HUSQVARNA  
KAWASAKI  
KTM  
MOTO TM  
RIEJU  
SHERCO  
SUZUKI  
YAMAHA

<b>YFM 700 F Grizzly</b> 4-Stroke Please Note: Nicasil Piston Size -Std. Compression 9.2:1 -Forged Piston -Fuel Injection	<b>Piston kit</b> 01.2706.A 01.2706.B 01.2706.C	<b>Size</b> 101.94 101.95 101.96	<b>Ring Set</b> 02.6608 02.6608 02.6608	<b>Bearing</b> 23.6308YA3 '07-15 2x 23.6308YA3 '19-23 2x	<b>Con. Rod Kit</b> 03.2706 '07-15 03.2706 '19-23	<b>Complete</b> 34.2707 '07-13 34.2714 '14-15	<b>Cam Chain</b> 31.2706 '07-15 31.2706 '19-23	<b>Valve</b> 28.2706-1 '07-15 2x Exhaust Steel 28.2706-1 '19-23 2x Exhaust Steel 28.2706-2 '07-15 2x Intake Steel 28.2706-2 '19-23 2x Intake Steel
Please Note: Nicasil Piston Size -Std. Compression 10.0:1 -Forged Piston -Fuel Injection	01.2714.A 01.2714.B 01.2714.C	101.94 101.95 101.96	02.6608 02.6608 02.6608		<b>B/E Bearing</b> 22.405022F '07-15 22.405022F '19-23	<b>Top-End</b> 35.2706 '07-13 35.2706 '14-15		<b>Valve Seal</b> 35.VS015 '07-15 4x 35.VS015 '19-23 4x
Please Note: Nicasil Piston Size -Std. Compression 10.0:1 -Forged Piston -Fuel Injection	01.2714.A 01.2714.B 01.2714.C	101.94 101.95 101.96	02.6608 02.6608 02.6608		<b>Crankpin</b> 06.4073.8 '07-15 06.4073.8 '19-23	<b>Head &amp; Base</b> 36.2706 '07-15+'19-23		
Please Note: Nicasil Piston Size -High Compression 11.0:1 -Forged Piston -Fuel Injection	<b>High Compression</b> 01.2707.A 01.2707.B	<b>Size</b> 101.94 101.95	<b>Ring Set</b> 02.6608 02.6608					
			<b>Pin</b> 04.2357.2 '07-15+'19-23					
			<b>Clips</b> 05.2318 '07-15+'19-23					

**STREET**  
APRILIA  
CAGIVA  
HONDA  
KAWASAKI  
KTM  
SUZUKI  
YAMAHA

<b>YXR 700 Rhino</b> 4-Stroke Please Note: Nicasil Piston Size -Std. Compression 9.2:1 -Forged Piston -Fuel Injection	<b>Piston kit</b> 01.2706.A 01.2706.B 01.2706.C	<b>Size</b> 101.94 101.95 101.96	<b>Ring Set</b> 02.6608 02.6608 02.6608	<b>Bearing</b> 23.6308YA3 '08-13 2x	<b>Con. Rod Kit</b> 03.2706 '08-13	<b>Complete</b> 34.2707 '08-13	<b>Cam Chain</b> 31.2706 '08-13	<b>Valve</b> 28.2706-1 '08-13 2x Exhaust Steel 28.2706-2 '08-13 2x Intake Steel
Please Note: Nicasil Piston Size -High Compression 11.0:1 -Forged Piston -Fuel Injection	<b>High Compression</b> 01.2707.A 01.2707.B	<b>Size</b> 101.94 101.95	<b>Ring Set</b> 02.6608 02.6608		<b>Crankpin</b> 06.4073.8 '08-13	<b>Head &amp; Base</b> 36.2706 '08-13		<b>Valve Seal</b> 35.VS015 '08-13 4x
			<b>Pin</b> 04.2357.2 '08-13					
			<b>Clips</b> 05.2318 '08-13					

**PWC**  
KAWASAKI  
POLARIS  
SEA DOO  
YAMAHA

<b>YXM 700 Viking</b> 4-Stroke Please Note: Nicasil Piston Size -Std. Compression 10.0:1 -Forged Piston -Fuel Injection	<b>Piston kit</b> 01.2714.A 01.2714.B 01.2714.C	<b>Size</b> 101.94 101.95 101.96	<b>Ring Set</b> 02.6608 02.6608 02.6608	<b>Bearing</b> 23.6308YA3 '14-23 2x	<b>Con. Rod Kit</b> 03.2706 '14-23	<b>Complete</b> 34.2707 '14-17	<b>Cam Chain</b> 31.2706 '14-23	<b>Valve</b> 28.2706-1 '14-23 2x Exhaust Steel 28.2706-2 '14-23 2x Intake Steel
			<b>Pin</b> 04.2357.2 '14-23		<b>B/E Bearing</b> 22.405022F '14-23	<b>Top-End</b> 35.2718 '14-23		<b>Valve Seal</b> 35.VS015 '14-23 4x
			<b>Clips</b> 05.2318 '14-23		<b>Crankpin</b> 06.4073.8 '14-23	<b>Head &amp; Base</b> 36.2706 '14-23		

**SNOW**  
ARCTIC CAT  
KAWASAKI  
LYNX  
MOTO-SKI  
POLARIS  
SKI DOO  
YAMAHA

**MOPED & SCOOTER**

**MISC. TECH. SPECIAL**

**DIRT**  
APRILIA  
BETA  
BMW  
GAS GAS  
HONDA  
HUSABERG  
HUSQVARNA  
KAWASAKI  
KTM  
MOTO TM  
RIEJU  
SHERCO  
SUZUKI  
YAMAHA

**STREET**  
APRILIA  
CAGIVA  
HONDA  
KAWASAKI  
KTM  
SUZUKI  
YAMAHA

**ATV-UTV**  
CAN-AM  
GAS GAS  
HONDA  
KAWASAKI  
KTM  
POLARIS  
SUZUKI  
YAMAHA

**PWC**  
KAWASAKI  
POLARIS  
SEA DOO  
YAMAHA

**SNOW**  
ARCTIC CAT  
KAWASAKI  
LYNX  
MOTO-SKI  
POLARIS  
SKI DOO  
YAMAHA

**MOPED & SCOOTER**

**MISC. TECH. SPECIAL**

<b>Air Filter</b> 52.27007 '07-15		<b>F/W Bearing</b> 23.S114096 '07-18 2x	<b>Front Pad Set</b> 37.255102 '07-23 Left 37.255102BX '07-23 Box of 10 37.265102 '07-23 Right 37.265102BX '07-23 Box of 10
<b>Water Pump Rebuild Kit</b> 57.2727 '07-15		<b>R/W Bearing</b> 23.S114096 '07-18 2x	<b>Rear Pad Set</b> 37.285102 '07-23 Left 37.285102BX '07-23 Box of 10 37.275102 '07-23 Right 37.275102BX '07-23 Box of 10
			<b>Front Caliper Rebuild Kit</b> 37.63027 '07-18
			<b>Rear Caliper Rebuild Kit</b> 37.63042 '07-18
			<b>Front Master Cylinder Rebuild Kit</b> 37.910004 '07-18
			<b>Rear Master Cylinder Rebuild Kit</b> 37.910020 '07-12 37.910004 '13-18

<b>Air Filter</b> 52.27008 '08-13		<b>F/W Bearing</b> 23.S111008 '08-13 2x	<b>Front Pad Set</b> 37.204302 '08-13 Left 37.204302BX '08-13 Box of 10 37.100202 '08-13 Right 37.100202BX '08-13 Box of 10
<b>Water Pump Rebuild Kit</b> 57.2727 '08-13			<b>Rear Pad Set</b> 37.204302 '08-13 Left 37.204302BX '08-13 Box of 10 37.100202 '08-13 Right 37.100202BX '08-13 Box of 10
			<b>PARKING PAD</b> 37.201202 '08-13

<b>Air Filter</b> 52.27014 '14-23			<b>Rear Caliper Rebuild Kit</b> 37.63004 '14-18
<b>Water Pump Rebuild Kit</b> 57.2727 '14-18			

Footnotes: \* Bearings Only



### YAMAHA

**DIRT**  
APRILIA  
BETA  
BMW  
GAS GAS  
HONDA  
HUSABERG  
HUSQVARNA  
KAWASAKI  
KTM  
MOTO TM  
RIEJU  
SHERCO  
SUZUKI  
YAMAHA

**STREET**  
APRILIA  
CAGIVA  
HONDA  
KAWASAKI  
KTM  
SUZUKI  
YAMAHA

**ATV-UTV**  
CAN-AM  
GAS GAS  
HONDA  
KAWASAKI  
KTM  
POLARIS  
SUZUKI  
YAMAHA

**PWC**  
KAWASAKI  
POLARIS  
SEA DOO  
YAMAHA

**SNOW**  
ARCTIC CAT  
KAWASAKI  
LYNX  
MOTO-SKI  
POLARIS  
SKI DOO  
YAMAHA

**MOPED & SCOOTER**

**MISC. TECH. SPECIAL**

<b>YFM 700 KODIAK</b> 4-Stroke Please Note: Nicasil Piston Size -Std. Compression 10.1:1 -Forged Piston -Fuel Injection	<b>Piston kit</b> -	<b>Size</b> 103.00	<b>Ring Set</b> -	<b>Bearing</b> 23.6308YA3 '19-23 2x	<b>Con. Rod Kit</b> 03.2706 '19-23	<b>Top-End</b> 35.2718 '19-23	<b>Cam Chain</b> 31.2706 '19-23	<b>Valve</b> 28.2706-1 '19-23 2x Exhaust Steel 28.2706-2 '19-23 2x Intake Steel
Please Note: Nicasil Piston Size -Std. Compression 10.0:1 -Forged Piston -Fuel Injection	01.2714.A 01.2714.B 01.2714.C '19-23	101.94 101.95 101.96	02.6608 02.6608 02.6608 '19-23	<b>Pin</b> 04.2357.2 '19-23	<b>B/E Bearing</b> 22.405022F '19-23	<b>Head &amp; Base</b> 36.2706 '19-23	<b>Valve Seal</b> 35.VS015 '19-23 4x	
			<b>Clips</b> 05.2318 '19-23					
<b>YXE 700 WOLVERINE R-SPEC</b> 4-Stroke Please Note: Nicasil Piston Size -Std. Compression 10.1:1 -Forged Piston -Fuel Injection	<b>Piston kit</b> -	<b>Size</b> 103.00	<b>Ring Set</b> -					
<b>YXE/F 850 WOLVERINE X4 /X2 / R-SPEC</b> 4-Stroke Please Note: Nicasil Piston Size -Std. Compression 10.5:1 -Fuel Injection	<b>Piston kit</b> -	<b>Size</b> 82.00	<b>Ring Set</b> -			<b>Cam Chain</b> 31.2818 '18-21		
<b>YXZ 1000 R</b> 4-Stroke Please Note: Nicasil Piston Size -Std. Compression 11.3:1 -Fuel Injection	<b>Piston kit</b> -	<b>Size</b> 80.00	<b>Ring Set</b> -			<b>Cam Chain</b> 31.2916 '16-23		

Footnotes: \* Bearings Only

			<b>F/W Bearing</b> 23.S114096 '16-18 2x	<b>Front Pad Set</b> 37.255102 '16-23 Left 37.255102BX '16-23 Box of 10 37.265102 '16-23 Right 37.265102BX '16-23 Box of 10				
			<b>R/W Bearing</b> 23.S114096 '16-18 2x	<b>Front Caliper Rebuild Kit</b> 37.63027 '16-18				
				<b>Rear Caliper Rebuild Kit</b> 37.63042 '16				
				<b>Front Master Cylinder Rebuild Kit</b> 37.910004 '16-18				
				<b>Rear Master Cylinder Rebuild Kit</b> 37.910004 '16				
<b>Air Filter</b> 52.27014 '16-17								

**DIRT**  
APRILIA  
BETA  
BMW  
GAS GAS  
HONDA  
HUSABERG  
HUSQVARNA  
KAWASAKI  
KTM  
MOTO TM  
RIEJU  
SHERCO  
SUZUKI  
YAMAHA

**STREET**  
APRILIA  
CAGIVA  
HONDA  
KAWASAKI  
KTM  
SUZUKI  
YAMAHA

**ATV-UTV**  
CAN-AM  
GAS GAS  
HONDA  
KAWASAKI  
KTM  
POLARIS  
SUZUKI  
YAMAHA

**PWC**  
KAWASAKI  
POLARIS  
SEA DOO  
YAMAHA

**SNOW**  
ARCTIC CAT  
KAWASAKI  
LYNX  
MOTO-SKI  
POLARIS  
SKI DOO  
YAMAHA

**MOPED & SCOOTER**

**MISC. TECH. SPECIAL**



**HYDROSPACE****DIRT**  
APRILIA  
BETA  
BMW  
GAS GAS  
HONDA  
HUSABERG  
HUSQVARNA  
KAWASAKI  
KTM  
MOTO TM  
RIEJU  
SHERCO  
SUZUKI  
YAMAHA

	Piston Kit	Size	Ring Set				
Hydrospace S4 2005-2009 4-Stroke	01.7705.A 01.7705.B 01.7705.C	84.94 84.95 84.96	02.7705 02.7705 02.7705				
-Std. Compression 9.0:1 -Forged Piston							

**KAWASAKI****STREET**  
APRILIA  
CAGIVA  
HONDA  
KAWASAKI  
KTM  
SUZUKI  
YAMAHA

	Piston Kit	Size	Ring Set	Clips	Bearing	S/E Bearing	
JS 300 1986-1988 JS 300 SX 1987-1991 2-Stroke	-	76.00	-	05.1812 '86-91	23.6305C3 '86-91 (2x)	21.4305 '86-91	
JS 440 1976-1992 2-Stroke	01.4503.025 01.4503.075 01.4503.125 01.4503.150 01.4503.175 01.4503.200	68.25 68.75 69.25 69.50 69.75 70.00	- 02.4503.075 02.4503.125 -	04.1659 '76-92  05.1610 '76-92	23.6206NR Mag Side 23.6305NR Inner #1&2 23.6206NR PTO Side	21.4504 '76-92	
JS 550 1982-1988 JS 550 SX 1989-1995 2-Stroke	01.4504.175	76.75	02.4504.175	04.1659 '82-95  05.1610 '82-95	23.6206NR Mag Side 23.6305NR Inner #1&2 23.6206NR PTO Side	21.4504 '82-95	35.4504 '91-95 76.00 mm

**ATV-UTV**  
CAN-AM  
GAS GAS  
HONDA  
KAWASAKI  
KTM  
POLARIS  
SUZUKI  
YAMAHA

	Piston Kit	Size	Ring Set	Clips	Bearing	S/E Bearing	Top-End
JS 650 SX 1987-1993 X-2 1986-1995 TS 1989-1996 SC 1991-1995 2-Stroke	-	76.00	-	05.1812 '86-96	23.6306C3 Mag Side 23.6306C3 Inner #1 23.6306NR Inner #2 23.6306C3 PTO Side  Oilseal Set 42.4505 '86-96	21.4305 '86-96	35.4505 '86-96

**PWC**  
HYDROSPACE  
KAWASAKI  
POLARIS  
SEA DOO  
YAMAHA

	Piston Kit	Size	Ring Set	Clips	Bearing	S/E Bearing	Top-End
JS 750 SS 1995-1996 Supersport Xi 1993-1995 750 SX 1992-1995 ST 1994-1995 XIR 1994 2-Stroke	-	80.00	-	05.2014 '92-96	23.6306C3 Mag Side 23.6306C3 Inner #1 23.6306NR Inner #2 23.6306C3 PTO Side  Oilseal Set 42.4505 '92-96	21.4510 '92-96  Crankpin 06.2658 '92-96	35.4510 '92-00

**SNOW**  
ARCTIC CAT  
KAWASAKI  
LYNX  
MOTO-SKI  
POLARIS  
SKI DOO  
YAMAHA

	Piston Kit	Size	Ring Set	Clips	Bearing	S/E Bearing	Top-End
JS 750 SS 1995-1996 Supersport Xi 1993-1995 750 SX 1992-1995 ST 1994-1995 XIR 1994 2-Stroke	-	80.00	-	05.2014 '92-96	23.6306C3 Mag Side 23.6306C3 Inner #1 23.6306NR Inner #2 23.6306C3 PTO Side  Oilseal Set 42.4505 '92-96	21.4510 '92-96  Crankpin 06.2658 '92-96	35.4510 '92-00

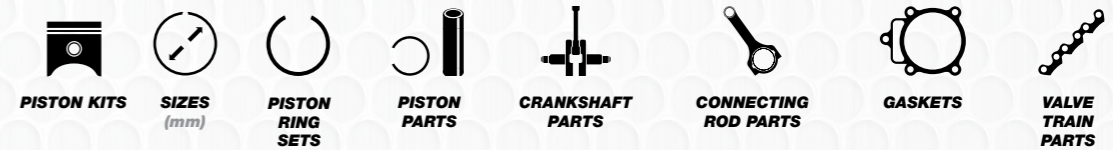
**MOPED & SCOOTER****MISC. TECH. SPECIAL****KAWASAKI****DIRT**  
APRILIA  
BETA  
BMW  
GAS GAS  
HONDA  
HUSABERG  
HUSQVARNA  
KAWASAKI  
KTM  
MOTO TM  
RIEJU  
SHERCO  
SUZUKI  
YAMAHA

	Piston Kit	Size	Ring Set	Clips	Bearing	S/E Bearing	Top-End
JS 750 SXi 1995-1996 750 STS 1995-1997 750 SS 1996-1997 Supersport Xi 1996-1997 750 ZXi 1995-1997 750 STX 1998 Xi Sport 1998-1999 750 SXi Pro 1998-2002 2-Stroke	01.4515.000 01.4515.050 01.4515.100 01.4515.150	80.00 80.50 81.00 81.50	02.4510.000 02.4510.050 02.4510.100 02.4510.150	05.2214 '95-02	23.6306C3 Mag Side 23.6306C3 Inner #1 23.6306NR Inner #2 23.6306C3 PTO Side  Oilseal Set 42.4505 '92-02	21.4512 '95-02  B/E Bearing 22.283620 '95-02	35.4510 '92-02

	Piston Kit	Size	Ring Set	Clips	Bearing	S/E Bearing	Top-End
800 SX-R 2003-2011 2-Stroke	01.4523.000 01.4523.025 01.4523.050 01.4523.100	82.00 82.25 82.50 83.00	02.4523.000 02.4523.025 02.4523.050 02.4523.100	05.2214 '03-11	23.6306C3 Mag Side 23.6306C3 Inner #1 23.6306NR Inner #2 23.6306C3 PTO Side  Oilseal Set 42.4505 '03-11	21.4512 '03-11  B/E Bearing 22.283620 '03-11	35.4523 '03-11

	Piston Kit	Size	Ring Set	Pin	Bearing	S/E Bearing	Top-End
900 ZXi 1995-1997 900 STX 1997-2006 900 STS 2001-2002 2-Stroke	-	73.00	-	04.2058.4 '95-06  05.2014 '95-06	23.52071LT Mag Side 23.6207NRLT Inner #1 23.83A844A Inner #2, 3, 4 23.83A948 PTO Side  Oilseal Set 42.4519 '95-06	21.4510 '95-06  B/E Bearing 22.263420 '95-06  Crankpin 06.2658 '95-06	35.4519 '95-06

	Piston Kit	Size	Ring Set	Clips	Bearing	S/E Bearing	Top-End
1100 ZXi 1996-2003 1100 STX 1997-1999 2-Stroke	01.4515.000 01.4515.050 01.4515.100 01.4515.150	80.00 80.50 81.00 81.50	02.4510.000 02.4510.050 02.4510.100 02.4510.150	05.2214 '96-04	23.52071LT Mag Side 23.6207NRLT Inner #1 23.83A844A Inner #2, 3, 4 23.83A948 PTO Side  Oilseal Set 42.4519 '96-04	21.4512 '96-04	35.4514 '96-04

	Piston Kit	Size	Ring Set				Top-End
Ultra 150 1999-2005 STX-R 1200 2002-2005 2-Stroke Please Note: Nikasil Piston Size	-	80.00	-				35.4529 '99-05

**STREET**  
APRILIA  
CAGIVA  
HONDA  
KAWASAKI  
KTM  
SUZUKI  
YAMAHA**ATV-UTV**  
CAN-AM  
GAS GAS  
HONDA  
KAWASAKI  
KTM  
POLARIS  
SUZUKI  
YAMAHA**PWC**  
HYDROSPACE  
KAWASAKI  
POLARIS  
SEA DOO  
YAMAHA**SNOW**  
ARCTIC CAT  
KAWASAKI  
LYNX  
MOTO-SKI  
POLARIS  
SKI DOO  
YAMAHA**MOPED & SCOOTER****MISC. TECH. SPECIAL**





### KAWASAKI

**DIRT**  
APRILIA  
BETA  
BMW  
GAS GAS  
HONDA  
HUSABERG  
HUSQVARNA  
KAWASAKI  
KTM  
MOTO TM  
RIEJU  
SHERCO  
SUZUKI  
YAMAHA

**STREET**  
APRILIA  
CAGIVA  
HONDA  
KAWASAKI  
KTM  
SUZUKI  
YAMAHA

**ATV-UTV**  
CAN-AM  
GAS GAS  
HONDA  
KAWASAKI  
KTM  
POLARIS  
SUZUKI  
YAMAHA

**PWC**  
HYDROSPACE  
KAWASAKI  
POLARIS  
SEA DOO  
YAMAHA

**SNOW**  
ARCTIC CAT  
KAWASAKI  
LYNX  
MOTO-SKI  
POLARIS  
SKI DOO  
YAMAHA

**MOPED & SCOOTER**

**MISC. TECH. SPECIAL**

Model	Piston Kit	Size (mm)	Ring Set	Bearing	S/E Bearing	Top-End
STX-12F 2003-2007 4-Stroke -Std. Compression 11.2:1	-	83.00	-			
STX-15F 2004-2014 STX 2009-2010 Ultra LX 2007-2014 4-Stroke Please Note: Nikasil Piston Size -Std. Compression 10.6:1 -Forged Piston	Piston Kit 01.4554.A 01.4554.B 01.4554.C	Size 82.95 82.96 82.97	Ring Set 02.4554 02.4554 02.4554			
Ultra 250 X 2007-2008 4-Stroke -Std. Compression 7.8:1	Piston Kit -	Size 83.00	Ring Set -			
Ultra 260 X 2009-2010 Ultra 260 LX 2009-2010 4-Stroke Please Note: Nikasil Piston Size -Std. Compression 7.8:1 -Forged Piston	Piston Kit 01.4559.B 01.4559.C	Size 82.96 82.97	Ring Set 02.4559 02.4559			
Ultra 300 X 2011-2013 Ultra 300 LX 2011-2013 4-Stroke Please Note: Nikasil Piston Size -Std. Compression 8.4:1 -Forged Piston	Piston Kit 01.4561.B 01.4561.C	Size 82.96 82.97	Ring Set 02.4559 02.4559			

### POLARIS

Model	Piston Kit	Size (mm)	Ring Set	Bearing	S/E Bearing	Top-End
SL 650 1992-1995 2-Stroke	-	65.00	-	Bearing 23.6207-26JR '92-95 6X  Oilseal Set 42.6680 '92-95	S/E Bearing 21.3303 '92-95	
SL/SLT 700 1996-1997 SLH/SLTH 700 1998-2004 2-Stroke	Piston Kit -	Size 81.00	Ring Set -	Bearing 23.6207C4 '96-04 6X	S/E Bearing 21.5507 '96-04	
SL/SLT 750 1993-1995 2-Stroke	Piston Kit -	Size 69.75	Ring Set -	Bearing 23.6207-26JR '93-95 6X  Oilseal Set 42.6680 '93-95	S/E Bearing 21.3303 '93-95	
SL/SLT 780 1995-1997 2-Stroke	Piston Kit -	Size 71.30	Ring Set -	Bearing 23.6207-26JR '93-97 6X  Oilseal Set 42.6680 '95-97	S/E Bearing 21.3303 '95-97	Top-End 35.5540 '95-97
Polaris SL 900 1996-1997 2-Stroke	Piston Kit -	Size 74.50	Ring Set -	Bearing 23.6207C4 '96-97 8X	S/E Bearing 21.5507 '96-97	Top-End 35.5545 '96-97

### POLARIS

Model	Piston Kit	Size (mm)	Ring Set	Bearing	S/E Bearing	Top-End
Polaris SLTX/SLXH 1050 1996-1999 2-Stroke	-	81.00	-	Bearing 23.6207C4 '96-99 8X	S/E Bearing 21.5507 '96-99	Top-End 35.5560 '96-99

### SEA DOO

Model	Piston Kit	Size (mm)	Ring Set	Clips	Bearing	Con. Rod Kit	Top-End
SEA DOO 580 (581cc) 1988-1996 2-Stroke	-	76.00	-	05.1815 '88-96	Bearing 23.6305NR Inner #1 23.6206NR Inner #2  Oilseal Set 42.5506 '88-96	Con. Rod Kit 03.5506 '88-96  S/E Bearing 21.1316 '88-96	Top-End 35.5506 '92-96
SEA DOO 650 (657cc) XP/GTX/SPI/SPX 1993-1995 2-Stroke	Piston Kit -	Size 78.00	Ring Set -		Bearing 23.6206NRC4 Mag Side #1, 2 23.6206NRC4 Inner #1, 2  Oilseal Set 42.5507 '93-95	Con. Rod Kit 03.5507 '93-95  S/E Bearing 21.5507 '93-95	Top-End 35.5507 '93-95
SEA DOO 720 (717cc) XP/GTI/HX/SPX GTS/GS/GSI 1995-2005 2-Stroke	Piston Kit -	Size 82.00	Ring Set -	Pin 04.2060.5 '95-05  Clips 05.2015 '95-05	Oilseal Set 42.5507 '95-05	S/E Bearing 21.5510 '95-05  B/E Bearing 22.263318 '95-05  Crankpin 06.2653 '95-05 06.2655 '95-05	Top-End 35.5508 '95-05
SEA DOO 785 (787cc) XP/SPX/GSX/GTX/GTX-RFI/GTI/GSX-RFI 1995-2005 2-Stroke	Piston Kit 01.5511.000 01.5511.050 01.5511.100 01.5511.150	Size 82.00 82.50 83.00 83.50	Ring Set - - - -	Pin 04.2060.5 '95-05  Clips 05.2015 '95-05	Oilseal Set 42.5510 '95-05	Con. Rod Kit 03.5510 '95-05  S/E Bearing 21.5510 '95-05  Crankpin 06.2855 '95-05	Top-End 35.5510 '95-99 35.5511 '00-05 RFI

**DIRT**  
APRILIA  
BETA  
BMW  
GAS GAS  
HONDA  
HUSABERG  
HUSQVARNA  
KAWASAKI  
KTM  
MOTO TM  
RIEJU  
SHERCO  
SUZUKI  
YAMAHA

**STREET**  
APRILIA  
CAGIVA  
HONDA  
KAWASAKI  
KTM  
SUZUKI  
YAMAHA

**ATV-UTV**  
CAN-AM  
GAS GAS  
HONDA  
KAWASAKI  
KTM  
POLARIS  
SUZUKI  
YAMAHA

**PWC**  
HYDROSPACE  
KAWASAKI  
POLARIS  
SEA DOO  
YAMAHA

**SNOW**  
ARCTIC CAT  
KAWASAKI  
LYNX  
MOTO-SKI  
POLARIS  
SKI DOO  
YAMAHA

**MOPED & SCOOTER**

**MISC. TECH. SPECIAL**





### SEA DOO

**DIRT**  
APRILIA  
BETA  
BMW  
GAS GAS  
HONDA  
HUSABERG  
HUSQVARNA  
KAWASAKI  
KTM  
MOTO TM  
RIEJU  
SHERCO  
SUZUKI  
YAMAHA

**STREET**

APRILIA  
CAGIVA  
HONDA  
KAWASAKI  
KTM  
SUZUKI  
YAMAHA

**ATV-UTV**

CAN-AM  
GAS GAS  
HONDA  
KAWASAKI  
KTM  
POLARIS  
SUZUKI  
YAMAHA

**PWC**

HYDROSPACE  
KAWASAKI  
POLARIS  
SEA DOO  
YAMAHA

**SNOW**

ARCTIC CAT  
KAWASAKI  
LYNX  
MOTO-SKI  
POLARIS  
SKI DOO  
YAMAHA

**MOPED & SCOOTER**

**MISC. TECH. SPECIAL**

Model	Piston Kit	Size (mm)	Ring Set	Pin	Oilseal Set	Con. Rod Kit	Top-End	Valve
SEA DOO 950 (951cc) GSX-LTD/XP-LTD GTX-LTD/LRV/RX 1997-2005 2-Stroke	01.5515.000 01.5515.050 01.5515.100 01.5515.150	88.00 88.50 89.00 89.50	02.5515.000 02.5515.050 02.5515.100 02.5515.150	04.2165T '97-05  Clips 05.2115 '97-05	42.5515 '97-05	03.5515 '97-05  S/E Bearing 21.5515 '97-05  Crankpin 06.2857 '97-05	35.5512 '98-00 35.5513 '01-02 Carb Silver 35.5514 '00-07 Di	
SEA DOO 1500 RXP 2004-2009 4-Stroke  -Std. Compression 8.4:1 -Forged Piston	01.5594.000 01.5594.050 01.5594.100	100.00 100.50 101.00	02.5594.000 02.5594.050 02.5594.100	04.2363.5 '04-09  Clips 05.2318 '04-09			28.5594-1 '04-09 Exh. Steel 28.5594-2 '04-09 Int. Steel	
SEA DOO 1500 RXT 2005-2009 4-Stroke  -Std. Compression 8.4:1 -Forged Piston	01.5594.000 01.5594.050 01.5594.100	100.00 100.50 101.00	02.5594.000 02.5594.050 02.5594.100	04.2363.5 '05-09  Clips 05.2318 '05-09			28.5594-1 '05-09 Exh. Steel 28.5594-2 '05-09 Int. Steel	
SEA DOO RXP-X 255 2008-2009 4-Stroke  -Std. Compression 8.4:1 -Forged Piston	01.5594.000 01.5594.050 01.5594.100	100.00 100.50 101.00	02.5594.000 02.5594.050 02.5594.100	04.2363.5 '08-09  Clips 05.2318 '08-09			28.5594-1 '08-09 Exh. Steel 28.5594-2 '08-09 Int. Steel	
SEA DOO RXT-X 260 RS 2010-2015 4-Stroke  -Std. Compression 8.4:1 -Forged Piston	01.5594.000 01.5594.050 01.5594.100	100.00 100.50 101.00	02.5594.000 02.5594.050 02.5594.100	04.2363.5 '10-15  Clips 05.2318 '10-15			28.5594-1 '10-15 Exh. Steel 28.5594-2 '10-15 Int. Steel	
SEA DOO GTX 300 SEA DOO RXP 300 SEA DOO RXT 300 2016-2023 4-Stroke  -Std. Compression 8.4:1 -Forged Piston	01.5596.A 01.5596.B 01.5596.C	99.91 99.92 99.93	02.5596 02.5596 02.5596	05.2212 '16-23  Clips 05.2318 '16-23			28.5594-1 '16-23 Exh. Steel 28.5594-2 '16-23 Int. Steel	



### YAMAHA

Model	Piston Kit	Size (mm)	Ring Set	Pin	Bearing	Con. Rod Kit	Top-End	Valve
Watercraft 500 2-Stroke	-	-	-					
Superjet 650 1990-1993 Wave Runner 650 '90-96 2-Stroke	-	77.00	-		05.2012 '90-96	03.2510P '90-96  S/E Bearing 21.2510 '90-96	35.2506 '90-96	
BIG BORE 650 1990-1996 2-Stroke	01.2510.000 01.2510.025 01.2510.050 01.2510.100 01.2510.150 01.2510.200	81.00 81.25 81.50 82.00 82.50 83.00	02.2510.000 02.2510.025 02.2510.050 02.2510.100 02.2510.150 02.2510.200	04.2065.8 '90-96  Clips 05.2010 '90-96	23.6207YR9 Inner #1, 2  Oilseal Set 42.2510 '90-96	03.2510P '90-96  S/E Bearing 21.2510 '90-96		
Superjet 700 1994-2017 Wave Blaster 700 '93-04 Wave Raider 700 '94-97 Wave Runner 700 '93-04 Wave Venture 700 '95-04 XL 700 1995-2005 2-Stroke	01.2510.000 01.2510.025 01.2510.050 01.2510.100 01.2510.150 01.2510.200	81.00 81.25 81.50 82.00 82.50 83.00	02.2510.000 02.2510.025 02.2510.050 02.2510.100 02.2510.150 02.2510.200	04.2065.8 '93-17  Clips 05.2010 '93-17	23.6207YR9 Inner #1, 2  Oilseal Set 42.2510 '93-17	03.2510P '93-17  S/E Bearing 21.2510 '93-17	35.2508 '93-95 SJ 35.2510 '94-96 WR/WV 35.2512 '96-17 SJ	
GP 760 1996-2000 Wave Blaster 760 '96-00 Wave Raider 760 '96-00 Wave Runner 760 '96-00 Wave Venture 760 '96-00 XL 760 1996-2000 2-Stroke	01.2514.000 01.2514.025 01.2514.050 01.2514.100 01.2514.150	84.00 84.25 84.50 85.00 85.50	02.2514.000 02.2514.025 02.2514.050 02.2514.100 02.2514.150	04.2065.8 '96-00  Clips 05.2012 '96-00	23.6207YR9 Inner #1, 2  Oilseal Set 42.2510 '96-00	03.2510P '96-00  S/E Bearing 21.2510 '96-00	35.2516 '96-00	
GP 800 R 1998-2005 XL 800 2000-2001 XLT 800 2002-2004 2-Stroke Please Note: Nikasil Piston Size	01.2518.A 01.2518.B 01.2518.C 01.2518.D & 01.2518.050	79.90 79.91 79.92 79.93	02.2518 02.2518 02.2518 02.2518	05.2212 '98-05  Clips 05.2212 '98-05	23.6308YR5 PTO Side  Oilseal Set 42.2518 '98-05	21.2518 '98-05  S/E Bearing 06.2768.3 '98-05	35.2518 '98-05	
Replating or Cylinder Sleeving Required for Oversizes								

**DIRT**  
APRILIA  
BETA  
BMW  
GAS GAS  
HONDA  
HUSABERG  
HUSQVARNA  
KAWASAKI  
KTM  
MOTO TM  
RIEJU  
SHERCO  
SUZUKI  
YAMAHA

**STREET**

APRILIA  
CAGIVA  
HONDA  
KAWASAKI  
KTM  
SUZUKI  
YAMAHA

**ATV-UTV**

CAN-AM  
GAS GAS  
HONDA  
KAWASAKI  
KTM  
POLARIS  
SUZUKI  
YAMAHA

**PWC**

HYDROSPACE  
KAWASAKI  
POLARIS  
SEA DOO  
YAMAHA

**SNOW**

ARCTIC CAT  
KAWASAKI  
LYNX  
MOTO-SKI  
POLARIS  
SKI DOO  
YAMAHA

**MOPED & SCOOTER**

**MISC. TECH. SPECIAL**





### YAMAHA

**DIRT**  
APRILIA  
BETA  
BMW  
GAS GAS  
HONDA  
HUSABERG  
HUSQVARNA  
KAWASAKI  
KTM  
MOTO TM  
RIEJU  
SHERCO  
SUZUKI  
YAMAHA

Wave Runner 1100 Wave Venture 1100 1995-1997 2-Stroke Triple	<b>Piston Kit</b> 01.2510.000 01.2510.025 01.2510.050 01.2510.100 01.2510.150 01.2510.200	<b>Size</b> 81.00 81.25 81.50 82.00 82.50 83.00	<b>Ring Set</b> 02.2510.000 02.2510.025 02.2510.050 02.2510.100 02.2510.150 02.2510.200	<b>Pin</b> 04.2065.8 '95-97 <b>Clips</b> 05.2010 '95-97	<b>Bearing</b> 23.6207YR9 Inner #1, 2, 3, 4 <b>Oilseal Set</b> 42.2510 '95-97	<b>Con. Rod Kit</b> 03.2510P '95-97 <b>S/E Bearing</b> 21.2510 '95-97	<b>Top-End</b> 35.2511 '95-97
GP 1200 1997-1999 XL 1200 1997-1999 SUV 1200 1999-2004 2-Stroke Triple	<b>Piston Kit</b> 01.2514.000 01.2514.025 01.2514.050 01.2514.100 01.2514.150	<b>Size</b> 84.00 84.25 84.50 85.00 85.50	<b>Ring Set</b> 02.2514.000 02.2514.025 02.2514.050 02.2514.100 02.2514.150	<b>Pin</b> 04.2065.8 '97-04 <b>Clips</b> 05.2012 '97-04	<b>Bearing</b> 23.6207YR9 Inner #1, 2, 3, 4 <b>Oilseal Set</b> 42.2510 '97-04	<b>Con. Rod Kit</b> 03.2510P '97-04 <b>S/E Bearing</b> 21.2510 '97-04	<b>Top-End</b> 35.2514 '97-04

**STREET**  
APRILIA  
CAGIVA  
HONDA  
KAWASAKI  
KTM  
SUZUKI  
YAMAHA

XL 1200 LTD 1998-2001 GP 1200 R 2000-2003 XLT 1200 2001-2005 2-Stroke Triple Please Note: Nikasil Piston Size Replating or Cylinder Sleeving Required for Oversizes	<b>Piston Kit</b> 01.2518.A 01.2518.B 01.2518.C 01.2518.D & 01.2518.050	<b>Size</b> 79.90 79.91 79.92 79.93 80.50	<b>Ring Set</b> 02.2518 02.2518 02.2518 02.2518 02.2518.050	<b>Clips</b> 05.2212 '98-05	<b>Bearing</b> 23.2307W11 Mag Side 23.6308YR5 PTO Side <b>Oilseal Set</b> 42.2520 '98-05	<b>S/E Bearing</b> 21.2518 '98-05 <b>Crankpin</b> 06.2768.3 '98-05	<b>Top-End</b> 35.2515 '98-05
--	---	--	--	-----------------------------------	---	---	-------------------------------------

**ATV-UTV**  
CAN-AM  
GAS GAS  
HONDA  
KAWASAKI  
KTM  
POLARIS  
SUZUKI  
YAMAHA

GP 1300 R 2003-2008 2-Stroke Triple Please Note: Nikasil Piston Size -Forged Piston	<b>Piston Kit</b> 01.2520.A 01.2520.B 01.2520.C	<b>Size</b> 83.90 83.91 83.92	<b>Ring Set</b> 02.2520 02.2520 02.2520	<b>Clips</b> 05.2212 '03-08	<b>Bearing</b> 23.2307W11 Mag Side 23.6308YR5 PTO Side	<b>S/E Bearing</b> 21.2518 '03-08 <b>Crankpin</b> 06.2768.3 '03-08	
FX 140 / FX 140 Cruiser 2003-2006 4-Stroke -Forged Piston	<b>Piston Kit</b> -	<b>Size</b> 74.00	<b>Ring Set</b> -				<b>Cam Chain</b> 31.1997 '03-08
VX110 Deluxe 2005-2014 VX110 Sport 2005-2014 VX110 Cruiser 2007-2014 V1 2015 V1 Sport 2015 4-Stroke Please Note: Nikasil Piston Size -4 Cylinder -Forged Piston -Std. Compression 11.4:1	<b>Piston Kit</b> 01.2905.A 01.2905.B 01.2905.C	<b>Size</b> 75.95 75.96 75.97	<b>Ring Set</b> - - -				<b>Cam Chain</b> 31.1997 '05-15

**PWC**  
HYDROSPACE  
KAWASAKI  
POLARIS  
SEA DOO  
YAMAHA

FX SHO 2008-2014 FX Cruiser SHO 2008-2014 FZR 2009-2013 FZS 2009-2013 4-Stroke Please Note: Nikasil Piston Size -4 Cylinder -Forged Piston -Std. Compression 11.4:1	<b>Piston Kit</b> 01.2909.A 01.2909.B 01.2909.C	<b>Size</b> 85.95 85.96 95.97	<b>Ring Set</b> - - -				
--	--	--	--------------------------------	--	--	--	--

**SNOW**  
ARCTIC CAT  
KAWASAKI  
LYNX  
MOTO-SKI  
POLARIS  
SKI DOO  
YAMAHA

FX SHO 2008-2014 FX Cruiser SHO 2008-2014 FZR 2009-2013 FZS 2009-2013 4-Stroke Please Note: Nikasil Piston Size -4 Cylinder -Forged Piston -Std. Compression 8.6:1	<b>Piston Kit</b> 01.2909.A 01.2909.B 01.2909.C	<b>Size</b> 85.95 85.96 95.97	<b>Ring Set</b> - - -				
---	--	--	--------------------------------	--	--	--	--

**MOPED & SCOOTER**

--	--	--	--	--	--	--	--

**MISC. TECH. SPECIAL**

--	--	--	--	--	--	--	--

**DIRT**  
APRILIA  
BETA  
BMW  
GAS GAS  
HONDA  
HUSABERG  
HUSQVARNA  
KAWASAKI  
KTM  
MOTO TM  
RIEJU  
SHERCO  
SUZUKI  
YAMAHA

--	--	--	--	--	--	--	--

**STREET**  
APRILIA  
CAGIVA  
HONDA  
KAWASAKI  
KTM  
SUZUKI  
YAMAHA

**ATV-UTV**  
CAN-AM  
GAS GAS  
HONDA  
KAWASAKI  
KTM  
POLARIS  
SUZUKI  
YAMAHA

**PWC**  
HYDROSPACE  
KAWASAKI  
POLARIS  
SEA DOO  
YAMAHA

**SNOW**  
ARCTIC CAT  
KAWASAKI  
LYNX  
MOTO-SKI  
POLARIS  
SKI DOO  
YAMAHA

**MOPED & SCOOTER**

**MISC. TECH. SPECIAL**

--	--	--	--	--	--	--	--



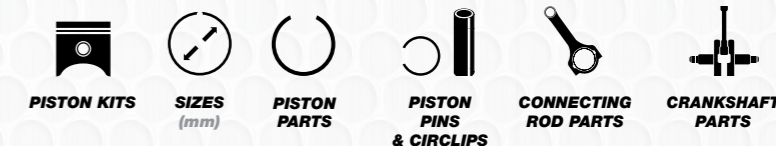
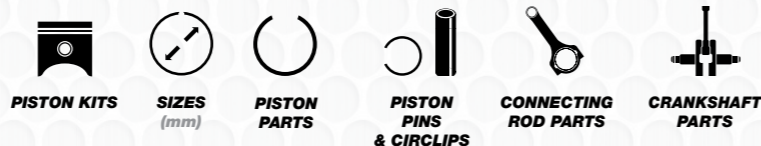

### ARCTIC CAT

DIRT	Model	Year	Piston Kit	Size	Ring Set	Clips	S/E Bearing	Top-End		
APRILIA BETA BMW GAS GAS HONDA HUSABERG HUSQVARNA KAWASAKI KTM MOTO TM RIEJU SHERCO SUZUKI YAMAHA	ZR 440 Snow Pro Twin Cylinder, 2-Stroke	1998-2001	-	66.50	-	-	21.5696	35.5498		
	Powder Special 500 EFI ZL 500 ZR 500 Twin Cylinder, 2-Stroke	2000 1998-2000 1998-2000	Piston Kit 01.5597.000	71.00	02.5597	05.2012	21.5698	35.5597		
	Note : A case series									
	Bearcat 550 Cheetah 550 Cougar 550 EXT 550 EXT 550 Mountain Cat EXT EFI 550 EXT Special 550 Pantera 550 Pantera 550 EFI Pantera 550 EFI Panther Prowler Two Up ZL 550 ZL 550 ESR Twin Cylinder, 2-Stroke	1995-2002 1994 1995-1998 1992-1993 1991-1995 1993-1994 1991 2004-2005 1993-1994 2003 1997-2001 1995 2001-2002 2000-2003	Piston Kit 01.5592.000	73.40	02.5592	05.2012	21.5698	35.5592		
	EXT 580 EXT 580 EFI EXT 580 Mountain Cat EXT 580Z EXT 580Z LC EXT Deluxe Pantera 580 Pantera 580 Pantera 580 EFI Powder Special 580 ZR 580 Twin Cylinder, 2-Stroke	1996-1998 1998 1993 1993-1994 1993-1997 1996-1998 1996-1998 2001 1999-2001 1996 1993-1997	Piston Kit 01.5593.000	75.40	02.5593	05.2012	21.5698	35.5592		
	EXT Triple 600 EXT Triple Touring Powder Extreme Triple Touring 600 ZRT 600 Triple Cylinder, 2-Stroke	1996-1997 1997-1998 1998 1999-2000 1996-2000	Piston Kit 01.5696.000	66.50	02.5696	05.1812	21.5696	35.5696		
	Powder Special 600 Powder Special 600 EFI Powder Special 600 EFI LE ZL 600 ZL 600 EFI ZR 600 ZR 600 EFI ZR 600 EFI LE ZR 600 EFI LE XC ZR 600 LE Twin Cylinder, 2-Stroke	1998-1999 1998-1999 1998-1999 1999 1999 1999 1998-1999 1998-1999 1998 1999	Piston Kit 01.5698.000	78.00	02.5601.000	05.2012	21.5698	35.5597		
	Note : A case series									
	KAWASAKI POLARIS SEA DOO YAMAHA	Mountain Cat 600 EFI Mountain Cat 600 EFI LE Mountain Cat 600 VEV Pantera 600 EFI Pantera 600 EFI ESR Powder Special 2K Powder Special 600 Powder Special 600 EFI Powder Special 600 EFI LE Powder Special 600 LE ZL 600 ZL 600 EFI ZL 600 EFI SS ZR 2K ZR 600 ZR 600 EFI ZR 600 EFI CC ZR 600 EFI LE ZR 600 EFI- LE Reverse ZR 600 VEV Twin Cylinder, 2-Stroke	2001-2004 2001 2001 2004-2005 2002-2003 2000 2000 2000 2000 2000 2000-2003 2002-2003 2000 2000-2002 2000-2002 2002 2000-2001 2000 2001	Piston Kit 01.5601.000	78.00	02.5601.000	05.2214	21.5807	35.5601 '00 35.5602 '01-05	
		Note : B case series								
KAWASAKI POLARIS SEA DOO YAMAHA		Mountain Cat 600 EFI Mountain Cat 600 EFI LE Mountain Cat 600 VEV Pantera 600 EFI Pantera 600 EFI ESR Powder Special 2K Powder Special 600 Powder Special 600 EFI Powder Special 600 EFI LE Powder Special 600 LE ZL 600 ZL 600 EFI ZL 600 EFI SS ZR 2K ZR 600 ZR 600 EFI ZR 600 EFI CC ZR 600 EFI LE ZR 600 EFI- LE Reverse ZR 600 VEV Twin Cylinder, 2-Stroke	2001-2004 2001 2001 2004-2005 2002-2003 2000 2000 2000 2000 2000 2000-2003 2002-2003 2000 2000-2002 2000-2002 2002 2000-2001 2000 2001	Piston Kit 01.5601.000	78.00	02.5601.000	05.2214	21.5807	35.5601 '00 35.5602 '01-05	
		Note : B case series								

### ARCTIC CAT

DIRT	Model	Year	Piston Kit	Size	Ring Set	Clips	S/E Bearing	Top-End
APRILIA BETA BMW GAS GAS HONDA HUSABERG HUSQVARNA KAWASAKI KTM MOTO TM RIEJU SHERCO SUZUKI YAMAHA	M 6000 Alpha One ES M 6000 SE/ES M 6000 Sno Pro /ES Riot 6000 ES Norseman 6000 /ES Pantera 6000 ES XF 6000 Cross Country LTD/ES XF 6000 Crosstour XF 6000 Crosstrek /ES XF 6000 High Country /ES/LTD ZR 6000 El Tigre ES ZR 6000 ES /LTD/LXR/RR ZR 6000 R SX ZR 6000 R XC ZR 6000 RR ES ZR 6000 RS LTD ES ZR 6000 Sno Pro ES Twin Cylinder, 2-Stroke	2019-2020 2014-2019 2014-2017 2020-2022 2018 2018 2017-2019 2018 2017-2018 2017-2019 2014-2018 2014-2021 2017 2016-2022 2017-2019 2017 2014-2019	Piston Kit 01.5614.000	73.80	02.5614	05.2012	21.2798	35.5614
	Crossfire 700 EFI Sno Pro Firecat 700 Firecat 700 EFI Firecat 700 EFI EXT Firecat 700 EFI R Firecat 700 EFI Sno Pro Firecat 700 Sno Pro M7 EFI M7 EFI LE Sabercat 700 EFI Sabercat 700 EFI EXT Sabercat 700 EFI LX Twin Cylinder, 2-Stroke	2006 2004-2006 2003-2006 2004-2005 2005-2006 2003-2006 2005-2006 2005 2005 2004-2005 2004-2005 2004-2005	Piston Kit 01.5703.000	79.70	02.5703	05.2214	21.5807	35.5703
	Mountain Cat 800 Mountain Cat 800 EFI Mountain Cat 800 LE Pantera 800 EFI Pantera 800 EFI ESR ZL 800 ZL 800 EFI ESR ZL 800 EFI SS ZR 800 ZR 800 EFI ZR 800 EFI Sno Pro ZR 800 LE Twin Cylinder, 2-Stroke	2001-2002 2002-2004 2001 2002-2004 2002-2003 2001 2002-2003 2002-2003 2001-2002 2002-2003 2003 2001	Piston Kit 01.5802.000	81.00	02.5802.000	05.2412	21.5802	35.5802
	CF8 CF8 LE Sno Pro CF8 Sno Pro CFR8 CFR8 LE Crossfire 800 EFI Crossfire 800 EFI Sno Pro F8 EFI F8 EFI LXR F8 EFI Sno Pro M8 M8 EFI M8 LE Sno Pro M8 Sno Pro Twin Cylinder, 2-Stroke	2009 2009 2009 2009 2009 2007-2008 2007-2008 2007-2009 2007-2009 2007-2009 2009 2007-2009 2009 2009	Piston Kit 01.5807.000	85.00	02.5807	05.2214	21.5807	35.5807
	CF8 CFR8 F8 EFI F8 Sno Pro M8 F800 Sno Pro M800 Sno Pro XF800 Sno Pro M8000 Sno Pro XF8000 Sno Pro ZR8000 Sno Pro Twin Cylinder, 2-Stroke	2010-2011 2010-2011 2010 2010-2011 2010-2011 2012-2013 2012-2013 2012-2013 2014-2017 2014-2017 2014-2017	Piston Kit 01.5811.000	85.00	02.5807	05.2214	21.5807	35.5811 Complete 34.5811
	M 8000 Mountain Cat / Sno Pro Norseman 8000 Riot 8000 XF 8000 Cross Country LTD ZR 8000 ES/LTD/RR ZR 8000 Sno Pro Twin Cylinder, 2-Stroke	2018 2018-2019 2020 2018-2019 2018-2019 2018-2019	Piston Kit 01.5818.000	85.00	02.5807	05.2215	21.5807	35.5828

DIRT	Model	Year	Piston Kit	Size	Ring Set	Clips	S/E Bearing	Top-End	
APRILIA BETA BMW GAS GAS HONDA HUSABERG HUSQVARNA KAWASAKI KTM MOTO TM RIEJU SHERCO SUZUKI YAMAHA	ZR 440 Snow Pro Twin Cylinder, 2-Stroke	1998-2001	-	66.50	-	-	21.5696	35.5498	
	Powder Special 500 EFI ZL 500 ZR 500 Twin Cylinder, 2-Stroke	2000 1998-2000 1998-2000	Piston Kit 01.5597.000	71.00	02.5597	05.2012	21.5698	35.5597	
	Note : A case series								
	Bearcat 550 Cheetah 550 Cougar 550 EXT 550 EXT 550 Mountain Cat EXT EFI 550 EXT Special 550 Pantera 550 Pantera 550 EFI Pantera 550 EFI Panther Prowler Two Up ZL 550 ZL 550 ESR Twin Cylinder, 2-Stroke	1995-2002 1994 1995-1998 1992-1993 1991-1995 1993-1994 1991 2004-2005 1993-1994 2003 1997-2001 1995 2001-2002 2000-2003	Piston Kit 01.5592.000	73.40	02.5592	05.2012	21.5698	35.5592	
	EXT 580 EXT 580 EFI EXT 580 Mountain Cat EXT 580Z EXT 580Z LC EXT Deluxe Pantera 580 Pantera 580 Pantera 580 EFI Powder Special 580 ZR 580 Twin Cylinder, 2-Stroke	1996-1998 1998 1993 1993-1994 1993-1997 1996-1998 1996-1998 2001 1999-2001 1996 1993-1997	Piston Kit 01.5593.000	75.40	02.5593	05.2012	21.5698	35.5592	
	EXT Triple 600 EXT Triple Touring Powder Extreme Triple Touring 600 ZRT 600 Triple Cylinder, 2-Stroke	1996-1997 1997-1998 1998 1999-2000 1996-2000	Piston Kit 01.5696.000	66.50	02.5696	05.1812	21.5696	35.5696	
	Powder Special 600 Powder Special 600 EFI Powder Special 600 EFI LE ZL 600 ZL 600 EFI ZR 600 ZR 600 EFI ZR 600 EFI LE ZR 600 EFI LE XC ZR 600 LE Twin Cylinder, 2-Stroke	1998-1999 1998-1999 1998-1999 1999 1999 1999 1998-1999 1998-1999 1998 1999	Piston Kit 01.5698.000	78.00	02.5601.000	05.2012	21.5698	35.5597	
	Note : A case series								
	KAWASAKI POLARIS SEA DOO YAMAHA	Mountain Cat 600 EFI Mountain Cat 600 EFI LE Mountain Cat 600 VEV Pantera 600 EFI Pantera 600 EFI ESR Powder Special 2K Powder Special 600 Powder Special 600 EFI Powder Special 600 EFI LE Powder Special 600 LE ZL 600 ZL 600 EFI ZL 600 EFI SS ZR 2K ZR 600 ZR 600 EFI ZR 600 EFI CC ZR 600 EFI LE ZR 600 EFI- LE Reverse ZR 600 VEV Twin Cylinder, 2-Stroke	2001-2004 2001 2001 2004-2005 2002-2003 2000 2000 2000 2000 2000 2000-2003 2002-2003 2000 2000-2002 2000-2002 2002 2000-2001 2000 2001	Piston Kit 01.5601.000	78.00	02.5601.000	05.2214	21.5807	35.5601 '00 35.5602 '01-05
		Note : B case series							











### YAMAHA

**DIRT**  
APRILIA  
BETA  
BMW  
GAS GAS  
HONDA  
HUSABERG  
HUSQVARNA  
KAWASAKI  
KTM  
MOTO TM  
RIEJU  
SHERCO  
SUZUKI  
YAMAHA

			Piston Kit	Size	Ring Set	Clips	S/E Bearing	Top-End
Mountain Lite Phazer Venture 480 XL-V Twin Cylinder, 2-Stroke	1997-1999 1984-1998 1991-1998 1991-1993		-	72.00	-	05.1812	21.5400	35.2598
Phazer Venture XL Touring Twin Cylinder, 2-Stroke	1999-2001 1999-2000		-	72.00	-	05.1812	21.5400	35.2599
Mountain Max 600 Venture 600 V-Max 600 Twin Cylinder, 2-Stroke	1998-1999 1998 1994-1999		01.2697.000	74.80	02.2697	05.2012	21.2697	35.2694 '94-95  35.2697 '97-99

**STREET**  
APRILIA  
CAGIVA  
HONDA  
KAWASAKI  
KTM  
SUZUKI  
YAMAHA

			Piston Kit	Size	Ring Set	Clips	S/E Bearing
Mountain 700 SRX700 Triple Cylinder, 2-Stroke	1998 1998-2002		01.2798.000	69.00	02.2798	05.2012	21.2798
SX Viper SX Viper Mountain Venture 700 Triple Cylinder, 2-Stroke	2002-2004 2003-2006 2004		01.2798.000	69.00	02.2798	05.2012	21.2798
Sidewinder Tripple Cylinder, 4-Stroke Please Note: Nicasil piston Size -Std. Compression 9.0:1 -Turbo Charged -Fuel Injection -Forged Piston	2017-2023		01.2917.A 01.2917.B 01.2917.C	79.92 79.93 79.94	02.2917 02.2917 02.2917	02.2112	

**ATV-UTV**  
CAN-AM  
GAS GAS  
HONDA  
KAWASAKI  
KTM  
POLARIS  
SUZUKI  
YAMAHA

**PWC**  
KAWASAKI  
POLARIS  
SEA DOO  
YAMAHA

**SNOW**  
ARCTIC CAT  
KAWASAKI  
LYNX  
MOTO-SKI  
POLARIS  
SKI DOO  
YAMAHA

**MOPED & SCOOTER**

**MISC. TECH. SPECIAL**

**DIRT**  
APRILIA  
BETA  
BMW  
GAS GAS  
HONDA  
HUSABERG  
HUSQVARNA  
KAWASAKI  
KTM  
MOTO TM  
RIEJU  
SHERCO  
SUZUKI  
YAMAHA

**STREET**  
APRILIA  
CAGIVA  
HONDA  
KAWASAKI  
KTM  
SUZUKI  
YAMAHA

**ATV-UTV**  
CAN-AM  
GAS GAS  
HONDA  
KAWASAKI  
KTM  
POLARIS  
SUZUKI  
YAMAHA

**PWC**  
KAWASAKI  
POLARIS  
SEA DOO  
YAMAHA

**SNOW**  
ARCTIC CAT  
KAWASAKI  
LYNX  
MOTO-SKI  
POLARIS  
SKI DOO  
YAMAHA

**MOPED & SCOOTER**

**MISC. TECH. SPECIAL**



PISTON KITS



SIZES (mm)



PISTON RING SETS



PISTON PINS & CIRCLIPS



CRANKSHAFT PARTS



PISTON KITS



SIZES (mm)



PISTON RING SETS



PISTON PINS & CIRCLIPS



CRANKSHAFT PARTS



## APRILIA

Classic 50, RS 50, Minarelli AM-6 MX 50, RX 50 2-Stroke	<b>Piston Kit</b> 01.1010.130 01.1010.150 01.1010.175 01.1010.200	<b>Size</b> 40.30 40.50 40.75 41.00	<b>Ring Set</b> - - 02.1010.175 02.1010.200	<b>Clips</b> 05.1210C	<b>S/E Bearing</b> 21.7012  <b>Bearing</b> 23.6303C3 2x
Amico, Area 51, Gle, Rally, SR Replica, Scarabeo, Sonic, Sonic GP, SR, SR 50LC, SR Racing, SR Urban Kid, SR Viper 2-Stroke	<b>Piston Kit</b> 01.2006.000 01.2006.025 01.2006.050 01.2006.075 01.2006.100 01.2006.150 01.2006.200	<b>Size</b> 40.00 40.25 40.50 40.75 41.00 41.50 42.00	<b>Ring Set</b> - - - 02.2003.075 - 02.2003.150 02.2003.200	<b>Pin</b> 04.1033  <b>Clips</b> 05.1010	<b>S/E Bearing</b> 21.1000  <b>Bearing</b> 23.6204C3 2x
Habana Custom 2-Stroke	<b>Piston Kit</b> 01.3002.150 01.3002.175	<b>Size</b> 42.50 42.75	<b>Ring Set</b> 02.3001.150 -	<b>Pin</b> 04.1033  <b>Clips</b> 05.1009	<b>S/E Bearing</b> 21.3001
RS50 / RX 50 / SX 50 2-Stroke	<b>Piston Kit</b> 01.7010.A 01.7010.B 01.7010.C '06-08	<b>Size</b> 39.85 39.86 39.87	<b>Ring Set</b> - - - '06-08	<b>Clips</b> 05.1210C	<b>S/E Bearing</b> 21.7012 '06-08  <b>Bearing</b> 23.6204C3 '06-08

## BENELLI

491 GT Superbike, 491 RR Grand Prix, 491 ST, K2 Model 2001, Pepe 50 2-Stroke	<b>Piston Kit</b> 01.2006.000 01.2006.025 01.2006.050 01.2006.075 01.2006.100 01.2006.150 01.2006.200	<b>Size</b> 40.00 40.25 40.50 40.75 41.00 41.50 42.00	<b>Ring Set</b> - - - 02.2003.075 - 02.2003.150 02.2003.200	<b>Pin</b> 04.1033  <b>Clips</b> 05.1010	<b>S/E Bearing</b> 21.1000  <b>Bearing</b> 23.6204C3 2x
---	--	--	--	--	--

## BETA

Ark AC, Ark K Series, Ark LC, Eikon 50, Quadra 50, Tempo 2-Stroke	<b>Piston Kit</b> 01.2006.000 01.2006.025 01.2006.050 01.2006.075 01.2006.100 01.2006.150 01.2006.200	<b>Size</b> 40.00 40.25 40.50 40.75 41.00 41.50 42.00	<b>Ring Set</b> - - - 02.2003.075 - 02.2003.150 02.2003.200	<b>Pin</b> 04.1033  <b>Clips</b> 05.1010	<b>S/E Bearing</b> 21.1000  <b>Bearing</b> 23.6204C3 2x
--	--	--	--	--	--

## DAELIM

Tapo, Message II, S-Five 2-Stroke	<b>Piston Kit</b> 01.1010.000 01.1010.025 01.1010.050 01.1010.075 01.1010.100 01.1010.130 01.1010.150 01.1010.175 01.1010.200	<b>Size</b> 39.00 39.25 39.50 39.75 40.00 40.30 40.50 40.75 41.00	<b>Ring Set</b> 02.1010.000 02.1010.025 02.1010.050 02.1010.075 - - - 02.1010.175 02.1010.200	<b>Clips</b> 05.1210C	
--------------------------------------	--	--	--	--------------------------	--

## DERBI

Atlantis Air Cooled, Atlantis H20 Liquid Cooled, Atlantis H20 Wave LC, Atlantis Wave Air Cooled Courier, Manhattan, predator GP1, Predator LC, Predator O2, Red Bullet 2-Stroke	<b>Piston Kit</b> 01.3002.150 01.3002.175	<b>Size</b> 42.50 42.75	<b>Ring Set</b> 02.3001.150 -	<b>Pin</b> 04.1033  <b>Clips</b> 05.1009	<b>S/E Bearing</b> 21.1000
Senda R / X-Treme, Senda SM / X-Treme, GPR, GPR Racer Replica 2-Stroke Please Note: Nikasil Piston Size	<b>Piston Kit</b> 01.7010.A 01.7010.B 01.7010.C	<b>Size</b> 39.85 39.86 39.87	<b>Ring Set</b> - - -	<b>Clips</b> 05.1210	<b>S/E Bearing</b> 21.7012  <b>Bearing</b> 23.6204C3 2x

## GILERA

Runner SP Pro / Pure Jet, Stalker, DNA 2-Stroke	<b>Piston Kit</b> 01.7005.000 01.7005.025 01.7005.050 01.7005.100	<b>Size</b> 40.00 40.25 40.50 41.00	<b>Ring Set</b> - - - -	<b>Clips</b> 05.1210C	<b>S/E Bearing</b> 21.1003  <b>Bearing</b> 23.SC04B27 2x
RCR, SMT 2-Stroke Please Note: Nikasil Piston Size	<b>Piston Kit</b> 01.7010.A 01.7010.B 01.7010.C	<b>Size</b> 39.85 39.86 39.87	<b>Ring Set</b> - - -	<b>Clips</b> 05.1210C	<b>S/E Bearing</b> 21.7012  <b>Bearing</b> 23.6204C3 2x

## HONDA

Lead 50, Melody, NH 50, QR 50, Scoopy, SH 50, Camino 2-Stroke	<b>Piston Kit</b> 01.1002.175	<b>Size</b> 41.75	<b>Ring Set</b> -	<b>Pin</b> 04.1033  <b>Clips</b> 05.1009	
MB, MT 50 2-Stroke	<b>Piston Kit</b> 01.1003.100	<b>Size</b> 40.00	<b>Ring Set</b> -	<b>Pin</b> 04.1231.5  <b>Clips</b> 05.1210C	<b>S/E Bearing</b> 21.1003  <b>B/E Pin</b> 06.1640
MTX, MBX 50, NSR 50 2-Stroke	<b>Piston Kit</b> -	<b>Size</b> 39.00	<b>Ring Set</b> -		<b>S/E Bearing</b> 21.1003
Tact 50, Spree 50, Aero 50 2-Stroke	<b>Piston Kit</b> 01.1008.125	<b>Size</b> 42.25	<b>Ring Set</b> -	<b>Pin</b> 04.1033  <b>Clips</b> 05.1009	
Vision 50 2-Stroke	<b>Piston Kit</b> 01.1008.125	<b>Size</b> 42.25	<b>Ring Set</b> -	<b>Pin</b> 04.1033  <b>Clips</b> 05.1009	<b>S/E Bearing</b> 21.1000
New Tact 50 2-Stroke	<b>Piston Kit</b> 01.1010.000 01.1010.025 01.1010.050 01.1010.075 01.1010.100 01.1010.130 01.1010.150 01.1010.175 01.1010.200	<b>Size</b> 39.00 39.25 39.50 39.75 40.00 40.30 40.50 40.75 41.00	<b>Ring Set</b> 02.1010.000 02.1010.025 02.1010.050 02.1010.075 - - - 02.1010.175 02.1010.200	<b>Clips</b> 05.1210C	

MOPED & SCOOTER  
APRILIA  
BENELLI  
BETA  
DAELIM  
DERBI  
GILERA  
HONDA  
HYOSUNG  
IBESTON  
ITALJET  
KYMCO  
MALAGUTI  
MBK  
MOTO ADLY  
MOTO HISPANIA  
MOTONIX  
PEUGEOT  
PGO  
PIAGGIO  
RIEJU  
SHERCO  
SHE-LUNG  
SUZUKI  
SYM  
TGB  
YAMAHA

MOPED & SCOOTER  
APRILIA  
BENELLI  
BETA  
DAELIM  
DERBI  
GILERA  
HONDA  
HYOSUNG  
IBESTON  
ITALJET  
KYMCO  
MALAGUTI  
MBK  
MOTO ADLY  
MOTO HISPANIA  
MOTONIX  
PEUGEOT  
PGO  
PIAGGIO  
RIEJU  
SHERCO  
SHE-LUNG  
SUZUKI  
SYM  
TGB  
YAMAHA

MISC. TECH. SPECIAL

MISC. TECH. SPECIAL



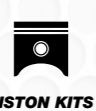

PISTON KITS



SIZES (mm)



PISTON RING SETS



PISTON PINS & CIRCLIPS



CRANKSHAFT PARTS

## HONDA

	Piston Kit	Size	Ring Set	Clips	Con. Rod Kit
Dio 50 2-Stroke	01.1010.000 01.1010.025 01.1010.050 01.1010.075 01.1010.100 01.1010.130 01.1010.150 01.1010.175 01.1010.200	39.00 39.25 39.50 39.75 40.00 40.30 40.50 40.75 41.00	02.1010.000 02.1010.025 02.1010.050 02.1010.075 - - - 02.1010.175 02.1010.200	05.1210C	03.1010   <b>S/E Bearing</b> 21.1003
SS / CS / Dax 50 4-Stroke	-	39.00	-	05.1310	
SS / C 50 / 70 4-Stroke	-	-	-	-	Con. Rod Kit 03.1050
Big Bore SS50 Monkey 4-Stroke	01.1052.100	52.00	-	-	Con. Rod Kit 03.1050
Wallaroo 2-Stroke	-	40.00	-	-	

## HYOSUNG

	Piston Kit	Size	Ring Set	Pin	S/E Bearing
Fast SF 50, Rush, Rush Challenger, Rush RX, Super Cab 50 2-Stroke	01.3002.150 01.3002.175	42.50 42.75	02.3001.150 -	04.1033  Clips 05.1009	21.1000

## IBESTON

	Piston Kit	Size	Ring Set	Clips	S/E Bearing
CL-QT-A 50 2-Stroke	01.1010.000 01.1010.025 01.1010.050 01.1010.075 01.1010.100 01.1010.130 01.1010.150 01.1010.175 01.1010.200	39.00 39.25 39.50 39.75 40.00 40.30 40.50 40.75 41.00	02.1010.000 02.1010.025 02.1010.050 02.1010.075 - - - 02.1010.175 02.1010.200	05.1210C	21.1003

## ITALJET

	Piston Kit	Size	Ring Set	Pin	S/E Bearing
Dragster 50 Racing 2-Stroke	01.2006.000 01.2006.025 01.2006.050 01.2006.075 01.2006.100 01.2006.150 01.2006.200	40.00 40.25 40.50 40.75 41.00 41.50 42.00	- - - 02.2003.075 - 02.2003.150 02.2003.200	04.1033  Clips 05.1010	21.1000  <b>Bearing</b> 23.6204C3 2x
Formula 50 Liquid Cooled, Formula 50 Techno Air, Jackpot 50, Torpedo 50, 2-Stroke	01.3002.150 01.3002.175	42.50 42.75	02.3001.150 -	04.1033  Clips 05.1009	21.1000

## KYMCO

	Piston Kit	Size	Ring Set	Clips	Con. Rod Kit
Fever ZX, KB 50, People 50, Scout 50, Super 9 50 2-Stroke	01.1010.000 01.1010.025 01.1010.050 01.1010.075 01.1010.100 01.1010.130 01.1010.150 01.1010.175 01.1010.200	39.00 39.25 39.50 39.75 40.00 40.30 40.50 40.75 41.00	02.1010.000 02.1010.025 02.1010.050 02.1010.075 - - - 02.1010.175 02.1010.200	05.1210C	03.1010   <b>S/E Bearing</b> 21.1003
DJ 50 2-Stroke	01.1010.000 01.1010.025 01.1010.050 01.1010.075 01.1010.100 01.1010.130 01.1010.150 01.1010.175 01.1010.200	39.00 39.25 39.50 39.75 40.00 40.30 40.50 40.75 41.00	02.1010.000 02.1010.025 02.1010.050 02.1010.075 - - - 02.1010.175 02.1010.200	05.1210C	03.1010   <b>S/E Bearing</b> 21.1003

## MALAGUTI

	Piston Kit	Size	Ring Set	Pin	Bearing
Ciak 50 Twin Disks, F10 Jet Line, Firefox F15 D.D. Grafico, Firefox F15 S.D., Firefox F15 TDS, Gentro SL, Phantom F12 50 Foggy Rep., Phantom F12 Digit, Phantom F12 Spectrum, Phantom F12 Air Cooled, Yesterday 2-Stroke	01.2006.000 01.2006.025 01.2006.050 01.2006.075 01.2006.100 01.2006.150 01.2006.200	40.00 40.25 40.50 40.75 41.00 41.50 42.00	- - - 02.2003.075 - 02.2003.150 02.2003.200	04.1033  Clips 05.1010	23.6204C3 2x

## MBK

	Piston Kit	Size	Ring Set	Pin	Bearing
Booster 50 NG, Flipper, Nitro, Ovetto, Stunt 50 Fishbone 2-Stroke	01.2006.000 01.2006.025 01.2006.050 01.2006.075 01.2006.100 01.2006.150 01.2006.200	40.00 40.25 40.50 40.75 41.00 41.50 42.00	- - - 02.2003.075 - 02.2003.150 02.2003.200	04.1033  Clips 05.1010	23.6204C3 2x

	Piston Kit	Size	Ring Set	Clips	S/E Bearing
X-Power 2-Stroke	01.1010.130 01.1010.150 01.1010.175 01.1010.200	40.30 40.50 40.75 41.00	- - 02.1010.175 02.1010.200	05.1210C	21.7012  <b>Bearing</b> 23.6303C3 2x

## MOTO ADLY

	Piston Kit	Size	Ring Set	Pin	Bearing
Panther, Silver Fox, Plus 50, Super Sonic 50 2-Stroke	01.2006.000 01.2006.025 01.2006.050 01.2006.075 01.2006.100 01.2006.150 01.2006.200	40.00 40.25 40.50 40.75 41.00 41.50 42.00	- - - 02.2003.075 - 02.2003.150 02.2003.200	04.1033  Clips 05.1010	23.6304C3 2x

## MOTO HISPANIA

	Piston Kit	Size	Ring Set	Clips	S/E Bearing
RX, Furia 2-Stroke	01.1010.130 01.1010.150 01.1010.175 01.1010.200	40.30 40.50 40.75 41.00	- - 02.1010.175 02.1010.200	05.1210C	21.7012  <b>Bearing</b> 23.6303C3 2x





**MOPED & SCOOTER**  
 APRILIA  
 BENELLI  
 BETA  
 DAELIM  
 DERBI  
 GILERA  
 HONDA  
 HYOSUNG  
 IBESTON  
 ITALJET  
 KYMCO  
 MALAGUTI  
 MBK  
 MOTO ADLY  
 MOTO HISPANIA  
 MOTONIX  
 PEUGEOT  
 PGO  
 PIAGGIO  
 RIEJU  
 SHERCO  
 SHE-LUNG  
 SUZUKI  
 SYM  
 TGB  
 YAMAHA

**MOPED & SCOOTER**  
 APRILIA  
 BENELLI  
 BETA  
 DAELIM  
 DERBI  
 GILERA  
 HONDA  
 HYOSUNG  
 IBESTON  
 ITALJET  
 KYMCO  
 MALAGUTI  
 MBK  
 MOTO ADLY  
 MOTO HISPANIA  
 MOTONIX  
 PEUGEOT  
 PGO  
 PIAGGIO  
 RIEJU  
 SHERCO  
 SHE-LUNG  
 SUZUKI  
 SYM  
 TGB  
 YAMAHA

**MOTONIX**

Navigator 50, Powerline 2-Stroke	<b>Piston Kit</b> 01.2006.000 01.2006.025 01.2006.050 01.2006.075 01.2006.100 01.2006.150 01.2006.200	<b>Size</b> 40.00 40.25 40.50 40.75 41.00 41.50 42.00	<b>Ring Set</b> - - - 02.2003.075 - 02.2003.150 02.2003.200	<b>Pin</b> 04.1033  <b>Clips</b> 05.1010	<b>Bearing</b> 23.6204C3 2x
----------------------------------	--	--	--	--	-----------------------------------

**PEUGEOT**

SC 2-Stroke	<b>Piston Kit</b> 01.1002.175	<b>Size</b> 41.75	<b>Ring Set</b> -	<b>Pin</b> 04.1033  <b>Clips</b> 05.1009	<b>S/E Bearing</b> 21.1000  <b>S/E Bearing</b> 21.1000
Rapido, ST 2-Stroke	<b>Piston Kit</b> 01.1008.125	<b>Size</b> 42.25	<b>Ring Set</b> -	<b>Pin</b> 04.1033  <b>Clips</b> 05.1009	

**PGO**

Big Max 50, Comet 50, PMS 50, PM-X 50, PM-X 50 Sport, Rodoshow 50, T-Rex 50 2-Stroke	<b>Piston Kit</b> 01.2006.000 01.2006.025 01.2006.050 01.2006.075 01.2006.100 01.2006.150 01.2006.200	<b>Size</b> 40.00 40.25 40.50 40.75 41.00 41.50 42.00	<b>Ring Set</b> - - - 02.2003.075 - 02.2003.150 02.2003.200	<b>Pin</b> 04.1033  <b>Clips</b> 05.1010	<b>Bearing</b> 23.6204C3 2x
--	--	--	--	--	-----------------------------------

**PIAGGIO**

Typhoon 50 2-Stroke	<b>Piston Kit</b> 01.7005.000 01.7005.025 01.7005.050 01.7005.100	<b>Size</b> 40.00 40.25 40.50 41.00	<b>Ring Set</b> - - - -	<b>Clips</b> 05.1210C	<b>S/E Bearing</b> 21.1003
Free 2T50, Liberty 50, NRG 50 Extreme DD/DT, NRG MC3DD, Vespa ET2, Zip Eco, Zip II 50 Cat. DT, Zip Sp 2-Stroke	<b>Piston Kit</b> 01.7005.000 01.7005.025 01.7005.050 01.7005.100	<b>Size</b> 40.00 40.25 40.50 41.00	<b>Ring Set</b> - - - -	<b>Clips</b> 05.1210C	<b>S/E Bearing</b> 21.1003
Pista, Rocco, Screnna, Zeppa, 2-Stroke	<b>Piston Kit</b> 01.2006.000 01.2006.025 01.2006.050 01.2006.075 01.2006.100 01.2006.150 01.2006.200	<b>Size</b> 40.00 40.25 40.50 40.75 41.00 41.50 42.00	<b>Ring Set</b> - - 02.2003.075 - 02.2003.150 02.2006.200	<b>Pin</b> 04.1033  <b>Clips</b> 05.1010	<b>Bearing</b> 23.6204C3 2x
Rivanna, Scorza, Speedline, 303 T, 202 T, Acrostec 2-Stroke	<b>Piston Kit</b> 01.3002.150 01.3002.175	<b>Size</b> 42.50 42.75	<b>Ring Set</b> 02.3001.150 -	<b>Pin</b> 04.1033  <b>Clips</b> 05.1009	

**RIEJU**

RS 1, RS 1 Evolution, Spike, RR, Racing, Drac RR 50, RS 2 2-Stroke	<b>Piston Kit</b> 01.1010.130 01.1010.150 01.1010.175 01.1010.200	<b>Size</b> 40.30 40.50 40.75 41.00	<b>Ring Set</b> - - 02.1010.175 02.1010.200	<b>Clips</b> 05.1210C	<b>S/E Bearing</b> 21.7012  <b>Bearing</b> 23.6303C3 2x
--	---	---	---	--------------------------	--

**SHERCO**

Enduro 50 Supermotard 50 Champion Replica Ipone Replica 2-Stroke	<b>Piston Kit</b> 01.1010.130 01.1010.150 01.1010.175 01.1010.200	<b>Size</b> 40.30 40.50 40.75 41.00	<b>Ring Set</b> - - 02.1010.175 02.1010.200	<b>Clips</b> 05.1210C	<b>S/E Bearing</b> 21.7012  <b>Bearing</b> 23.6303C3 2x
--	---	---	---	--------------------------	--

**SHE-LUNG**

Alunix 50 2-Stroke	<b>Piston Kit</b> 01.2006.000 01.2006.025 01.2006.050 01.2006.075 01.2006.100 01.2006.150 01.2006.200	<b>Size</b> 40.00 40.25 40.50 40.75 41.00 41.50 42.00	<b>Ring Set</b> - - - 02.2003.075 - 02.2003.150 02.2003.200	<b>Pin</b> 04.1033  <b>Clips</b> 05.1010	<b>Bearing</b> 23.6204C3 2x
--------------------	--	--	--	--	-----------------------------------

**SUZUKI**

Katana 50 2-Stroke Please Note: Needs Modification	<b>Piston Kit</b> -	<b>Size</b> -	<b>Ring Set</b> -		<b>Con. Rod Kit</b> 03.1010  <b>S/E Bearing</b> 21.1003  <b>B/E Pin</b> 06.1846
TS 50 ER TS 50 X LT 50 RG 5 0W 2-Stroke	<b>Piston Kit</b> 01.3001.000 01.3001.050 01.3001.100 01.3001.150 01.3001.200	<b>Size</b> 41.00 41.50 42.00 42.50 43.00	<b>Ring Set</b> - - 02.3001.100 02.3001.150 -	<b>Clips</b> 05.1210C	<b>S/E Bearing</b> 03.3001 21.3001
TS 50 ER / X Automatic 2-Stroke	<b>Piston Kit</b> -	<b>Size</b> -	<b>Ring Set</b> -		<b>S/E Bearing</b> 21.1000
JR / FA / FS / FZ 50 2-Stroke	<b>Piston Kit</b> 01.3001.000 01.3001.050 01.3001.100 01.3001.150 01.3001.200	<b>Size</b> 41.00 41.50 42.00 42.50 43.00	<b>Ring Set</b> - - 02.3001.100 02.3001.150 -	<b>Clips</b> 05.1210C	
Estilete 50, GT 50, Katana R, Zillion W 50 ZR 50 2-Stroke	<b>Piston Kit</b> 01.3001.000 01.3001.050 01.3001.100 01.3001.150 01.3001.200	<b>Size</b> 41.00 41.50 42.00 42.50 43.00	<b>Ring Set</b> - - 02.3001.100 02.3001.150 -	<b>Clips</b> 05.1210C	
AD 50, Address Italjet 2-Stroke	<b>Piston Kit</b> 01.3002.150 01.3002.175	<b>Size</b> 42.50 42.75	<b>Ring Set</b> 02.3001.150 -	<b>Pin</b> 04.1033  <b>Clips</b> 05.1009	<b>Con. Rod Kit</b> 03.3003  <b>S/E Bearing</b> 21.1000
CP 50 / CS 50 2-Stroke	<b>Piston Kit</b> 01.3002.150 01.3002.175	<b>Size</b> 42.50 42.75	<b>Ring Set</b> 02.3001.150 -	<b>Pin</b> 04.1033  <b>Clips</b> 05.1009	
FB 50 4-Stroke	<b>Piston Kit</b> 01.3004.025 01.3004.050 01.3004.100 01.3004.150	<b>Size</b> 39.25 39.50 40.00 40.50	<b>Ring Set</b> - - - -	<b>Clips</b> 05.1210C	

**MISC. TECH. SPECIAL**

**MISC. TECH. SPECIAL**



PISTON KITS



SIZES (mm)



PISTON RING SETS



PISTON PINS & CIRCLIPS



CRANKSHAFT PARTS



PISTON KITS



SIZES (mm)



PISTON RING SETS



PISTON PINS & CIRCLIPS



CRANKSHAFT PARTS



**MOPED & SCOOTER**

APRILIA  
BENELLI  
BETA  
DAELIM  
DERBI  
GILERA  
HONDA  
HYOSUNG  
IBESTON  
ITALJET  
KYMCO  
MALAGUTI  
MBK  
MOTO ADLY  
MOTO HISPANIA  
MOTONIX  
PEUGEOT  
PGO  
PIAGGIO  
RIEJU  
SHERCO  
SHE-LUNG  
SUZUKI  
SYM  
TGB  
YAMAHA

**SYM**

Pure 50 2-Stroke	<b>Piston Kit</b> 01.1010.000 01.1010.025 01.1010.050 01.1010.075 01.1010.100 01.1010.130 01.1010.150 01.1010.175 01.1010.200	<b>Size</b> 39.00 39.25 39.50 39.75 40.00 40.30 40.50 40.75 41.00	<b>Ring Set</b> 02.1010.000 02.1010.025 02.1010.050 02.1010.075 - - - 02.1010.175 02.1010.200	<b>Pin</b> 04.1233  <b>Clips</b> 05.1210C	
---------------------	--	--	--	---	--

**TGB**

F409 50, 303R 50 2-Stroke	<b>Piston Kit</b> 01.3002.150 01.3002.175	<b>Size</b> 42.50 42.75	<b>Ring Set</b> - -	<b>Pin</b> 04.1033  <b>Clips</b> 05.1009	
------------------------------	---	-------------------------------	---------------------------	--	--

**YAMAHA**

RD / DT 50 Liquid Cooled 2-Stroke	<b>Piston Kit</b> -	<b>Size</b> 40.00	<b>Ring Set</b> -		<b>Con. Rod Kit</b> 03.2001  <b>S/E Bearing</b> 21.2001
RD / DT 50-80 Air Cooled 2-Stroke	<b>Piston Kit</b> -	<b>Size</b> -	<b>Ring Set</b> -		<b>Con. Rod Kit</b> 03.2002  <b>S/E Bearing</b> 21.2001
MJ 50 / PW 50 2-Stroke	<b>Piston Kit</b> 01.2005.000 01.2005.050 01.2005.100 01.2005.150	<b>Size</b> 40.00 40.50 41.00 41.50	<b>Ring Set</b> - - - 02.2003.150	<b>Pin</b> 04.1033  <b>Clips</b> 05.1010G	<b>S/E Bearing</b> 21.2001  <b>Bearing</b> 23.6203C3 2x  <b>Oilseal Set</b> 42.2005
JOG 50, JOG 50 RR BWS Minarelli Aerox R, Beluga, Bumper, BW's R next generation/ Original / NG50, Neo's, Slider 50, WHY, Sting 2-Stroke	<b>Piston Kit</b> 01.2006.000 01.2006.025 01.2006.050 01.2006.075 01.2006.100 01.2006.150 01.2006.200	<b>Size</b> 40.00 40.25 40.50 40.75 41.00 41.50 42.00	<b>Ring Set</b> - - - 02.2003.075 - 02.2003.150 02.2003.200	<b>Pin</b> 04.1033  <b>Clips</b> 05.1010	<b>Con. Rod Kit</b> 03.2008  <b>S/E Bearing</b> 21.1000  <b>Bearing</b> 23.6204C3 2x
MA / SA / S / CT50 2-Stroke	<b>Piston Kit</b> -	<b>Size</b> -	<b>Ring Set</b> -		<b>Con. Rod Kit</b> 03.2008  <b>S/E Bearing</b> 21.1000
TZR 50 2-Stroke	<b>Piston Kit</b> 01.1010.130 01.1010.150 01.1010.175 01.1010.200	<b>Size</b> 40.30 40.50 40.75 41.00	<b>Ring Set</b> - - 02.1010.175 02.1010.200	<b>Clips</b> 05.1210C	<b>S/E Bearing</b> 21.7012  <b>Bearing</b> 23.6303C3 2x
Beluga / Venya 80 2-Stroke	<b>Piston Kit</b> -	<b>Size</b> 49.00	<b>Ring Set</b> -	<b>Clips</b> 05.1210C	

**MOPED & SCOOTER**





























APRILIA  
BENELLI  
BETA  
DAELIM  
DERBI  
GILERA  
HONDA  
HYOSUNG  
IBESTON  
ITALJET  
KYMCO  
MALAGUTI  
MBK  
MOTO ADLY  
MOTO HISPANIA  
MOTONIX  
PEUGEOT  
PGO  
PIAGGIO  
RIEJU  
SHERCO  
SHE-LUNG  
SUZUKI  
SYM  
TGB  
YAMAHA

**MISC. TECH. SPECIAL**

**MISC. TECH. SPECIAL**

# NEVER COMPROMISE, PRO RACING PARTS

## TECHNICAL TABLE OF CONTENTS

PRODUCTS		Page	PRODUCTS		Page
	04. Piston Pins	442		16. Clutch Plates	456
	05. Piston Clips	442		16.S Clutch Plate Set Assemblies	458
	21. Piston Pin Bearings	443		36. Head & Base Gasket sets	460
	03W. Thrustwashers	443		07.RC Drive Chains	463
	22. Big End Bearings	444		37. Brake Pads	463
	06. Big End Pins	444		23. Wheel Bearings	465
	23. Ball Bearings	445		24. Steering Bearings	465
	41. Crankshaft Oilseals	446		25. Swingarm Bearings	465
	31. Cam Chains	448		40. Frontfork Oil Seals & Dust Seals	465
	28. Engine Valves	449		43.HM Hour Meters	466
	29. Valve Shims	451		40.FSP Fork Protectors	466
	35.VS Valve Stem Seals	453		45-49 Jets & Jet Assortment Boxes	467
	17. Clutch Baskets	455		01. Piston Dimensions	470
	17.CRS Clutch Rubber Sets	455		03. Connecting Rod Dimensions	482















### Valve Installation Instructions

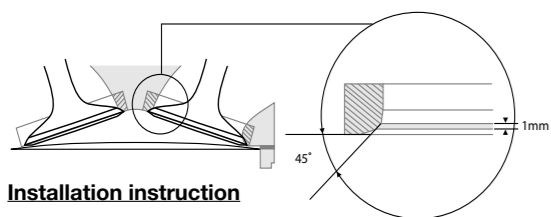

**ProX Titanium Engine Valves** are manufactured to the highest quality standards and specifications. By using the latest state of the art Titanium material and coating, the valves have improved properties over the original item. We would like to support you to achieve maximum durability. Titanium is a very exotic material which requires you to work after following installation instructions.

#### Installation instruction

- Do not touch the valve surface with your bare hands, use gloves or pre lube the valve with engine oil, these precautionary measures will reduce the risk of corroding the coating.
- Never** use a lapping compound on a new valve, take a dummy valve to do this grinding operation.
- Please take notice; during every rebuild the valve seats must be machined, this to assure a 100 % valve to seat contact and making the seat free from the hardened shell. The width of the contact zone on a valve seat with the valve face should be at least 1mm. In general the angle is 45°, however consult the O.E.M. specification first.
- New valve seats should be soft, material as Nodular Iron, Bronze, or Beryllium-Copper, all heat treated to Rockwell, RC32 or less. Most of the original valve seats used in combination with titanium valves are made of such an alloy.  
**Attention:** After every rebuild the seat is getting thinner which makes the heat transfer worse, increasing the natural hardening process. The back set position of the valve (Recess) after every time one machines the valve seat, worsening the engine's breathing. Besides of reducing the engine's efficiency this also effects the cooling down effect negatively.
- Use only original valve springs or ones with forces not exceeding the originals.

### NOTES



### CLUTCH BASKETS & CLUTCH DAMPENER SETS

#### (O.E.M. REPLACEMENT CLUTCH BASKETS)

ProX offers a complete line of clutch baskets kits for the Dirtbike and ATV segment. The ProX clutch baskets are manufactured from mainly forged 7075 alloy, like the material used in the aircraft and aerospace industry. The use of this material offers improved strength over the OEM die-cast alloy baskets. The ProX clutch baskets are machined to exact OEM specifications and tolerances for perfect fit. The complete surface of the baskets is hard anodised for higher mechanical properties and resistance for impact and fatigue. Most clutch baskets come complete with fasteners and damper rubbers for easy installation. The ProX baskets will work together with other ProX clutch components as well as OEM clutch components. A full line of ProX clutch baskets for Dirtbike and ATV models is available from stock.



Part No.	Notes	Rubbers	Qty.	Clutch Rubber Set	O.E.M. Reference
17.1220F	Rubbers Included	17.9-1287	8x	17.CRS1287-8	22100-KZ4-A90 22100-KRN-670 22100-KSC-A10 22100-KSE-670
17.1227F	-	-	-	-	22100-KZ4-700
17.1287F	Rubbers Included	17.9-1287	8x	17.CRS1287-8	22100-KRN-A40
17.1340F	Rubbers Included	17.9-1287	8x	17.CRS1287-8	22100-ML3-000
17.1386	Rubbers Included	17.9-1386	8x	17.CRS1386-8	22100-KZ3-000
17.1387	-	17.9-1386	8x	17.CRS1386-8	22100-KZ3-860 22100-MEB-770 22100-MEY-670
17.1403F	Rubbers Included	17.9-1386	8x	17.CRS1386-8	22100-MEN-A10
17.1408F	Rubbers Included	17.9-1386	8x	17.CRS1386-8	22100-MEN-A30
17.1409F	Rubbers Included	17.9-1386	8x	17.CRS1386-8	22100-MEN-A70
17.1413F	Rubbers Included	17.9-1386	8x	17.CRS1386-8	22100-KA5-700
17.1484	Rubbers Included	17.9-1386	8x	17.CRS1386-8	22100-ML3-910
17.1490	Rubbers Included	17.9-1386	8x	17.CRS1386-8	22100-KCY-670
17.1499F	-	-	-	-	22100-HN1-A40
17.1505F	-	-	-	-	31K-16150-01
17.2020	-	-	-	-	4ES-16150-00
17.2193F	-	-	-	-	5PA-16150-10
17.2196F	-	-	-	-	3JM-16150-01
17.2281F	-	-	-	-	5NY-16150-00
17.2293F	Rubbers Included	17.9-2288	6x	17.CRS2288-8	1C3-16150-00
17.2295	-	-	-	-	5DJ-16150-00
17.2393	Rubbers Included	17.9-2288	8x	17.CRS2288-8	5NL-16150-10
17.2401F	Rivets Included	-	-	-	3AJ-16150-00
17.2404F	-	-	-	-	5BE-16150-00
17.2406	-	-	-	-	5JG-16150-00
17.2423	Rubbers Included	17.9-2424	8x	17.CRS2424-8	5TA-16150-10
17.2424F	Rubbers Included	17.9-2424	8x	17.CRS2424-8	5XD-16150-60 5XD-16150-10 B11-16150-00
17.2434F	-	-	-	-	5TG-16150-00
17.3187F	-	-	-	-	21200-02B41
17.3292F	Rubbers Included	17.9-3292	8x	17.CRS3292-8	21200-36F00
17.3338F	Rubbers Included	17.9-3386	8x	17.CRS3386-8	21200-49H00
17.3393	Rubbers Included	17.9-3386	8x	17.CRS3386-8	21200-28C41
17.3396F	Rubbers Included	17.9-3386	8x	17.CRS3386-8	21200-37E00
17.3400F	-	-	-	-	21200-29F10 21200-07G10
17.3403	Rubbers Included	17.9-3386	8x	17.CRS3386-8	21200-37F10
17.3405F	Rubbers Included	17.9-3405	8x	17.CRS3405-8	21200-35G00
17.3408F	Rubbers Included	17.9-3405	8x	17.CRS3405-8	21200-28H00









# DRIVE CHAINS

ProX has developed a premium line of Roller Chains to team up together with the ProX front and rear sprockets. The ProX Roller Chain is a top quality chain, exclusively manufactured for ProX by the reputable and leading OEM factory in Japan.

All ProX chains are made using highest grade Japanese steel. The MX chains are assembled out of various different component that all have their specific and crucial function to make the chain a high quality product.

Specifically for the Offroad, Enduro, ATV and big 4-Stroke Motocross bikes ProX also offers a lightweight, narrow type X-Ring chain using a QX-type seal offering 40% less friction and at least 150% increased durability over a standard MX Chain.

All ProX chains are pre-stressed and pre-stretched to reduce initial chain stretch and immediate performance and come with a clip type chain link as standard.

## SPECIFICATIONS

Part No.	Chain		Roller		Pin		Plate Thickness		Weight Kg / 100 Links	Tensile Strength kN	Masterlink included	Remarks
	Type	Length	Width (mm.)	Diameter (mm.)	Diameter (mm.)	Length (mm.)	Inner (mm.)	Outer (mm.)				
07.RC420130C	420	130	6.35	7.75	3.95	17.30	2.00	2.00	1.01	23.1	Cliplink	MX Chain/Made in Japan
07.RC428130C	428	130	7.95	8.50	4.50	19.00	1.80	1.80	1.03	22.2	Cliplink	MX Chain/Made in Japan
07.RC520120C	520	120	6.35	10.15	5.25	17.50	2.00	2.00	1.52	39.7	Cliplink	MX Chain/Made in Japan
07.RC520120CG	520	120	6.35	10.15	5.25	17.50	2.00	2.00	1.52	39.7	Cliplink	MX Chain Gold/Made in Japan
07.RC520120XC	520	120	6.35	10.15	5.40	20.00	2.00	2.00	1.57	37.8	Cliplink	X-Ring Chain/Made in Japan
07.RC520120XCG	520	120	6.35	10.15	5.40	20.00	2.00	2.00	1.57	37.8	Cliplink	X-Ring Chain Gol /Made in Japan

### SEPERATE MASTERLINKS

Part No.	Type		Remarks
	Rivetlink	Cliplink	
07.RC420CL	-	X	MX Chain
07.RC428CL	-	X	MX Chain
07.RC520CL	-	X	MX Chain
07.RC520CLG	-	X	MX Chain Gold
07.RC520XCL	-	X	X-Ring Chain
07.RC520XCLG	-	X	X-Ring Chain Gold
07.RC520XRL	X	-	X-Ring Chain



# BRAKE PAD SCHEMATICS

ProX offers a wide program of high quality dirt bike brake discs, manufactured from specially hardened premium quality Stainless Steel. The ProX brake disc line is the ideal budget OEM-replacement brake disc. The specific lightweight wave designed brake discs comes with integrated venting slots to offer optimal cooling and cleaning of the brake pad contact surface. These features result in high performance and linear braking with very low brake pad wear. For best performance we recommend using ProX brake pads with a matching pad compound. The ProX brake pad schematics do show DIMENSIONS and shape of each individual brake pad set.







# PISTON DIMENSIONS

## 2-STROKE

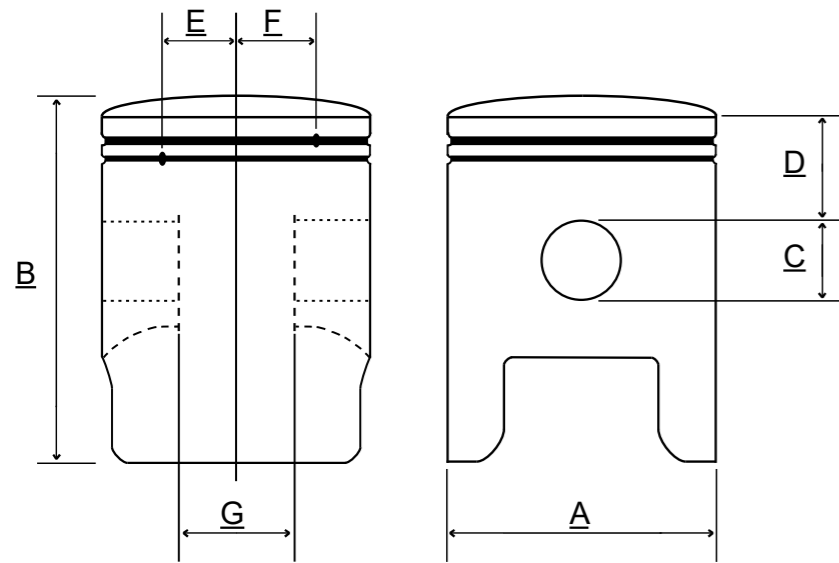

- A = Diameter \*
- B = Total height
- C = Pinhole diameter
- D = Compression height
- E = Ring location pin position from center
- F = Ring location pin position from center
- G = Pin boss spacing

All dimensions in mm.  
 \* In case of cast iron cylinder, piston bore diameter is mentioned  
 \* In case of nicasil cylinder, actual piston diameter is mentioned

## 4-STROKE

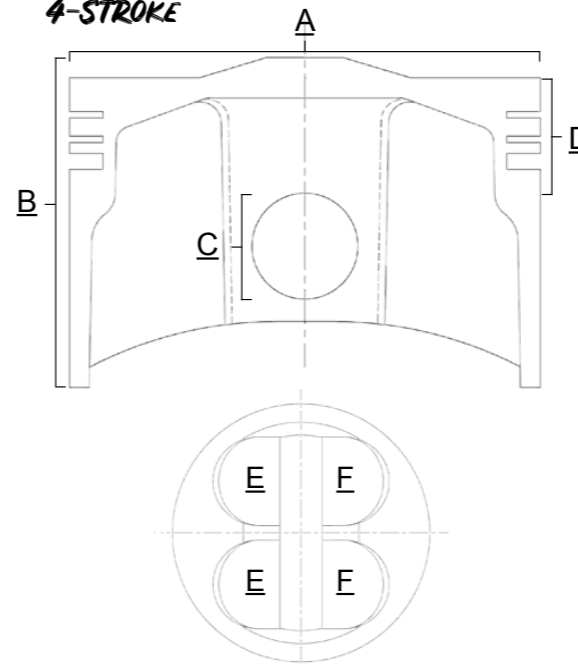

- A = Diameter \*
- B = Total height
- C = Pinhole diameter
- D = Compression height
- E = Intake valve pocket diameter
- F = Exhaust valve pocket diameter

All dimensions in mm.  
 \* In case of cast iron cylinder, piston bore diameter is mentioned  
 \* In case of nicasil cylinder, actual piston diameter is mentioned

### HONDA

Part No.	Engine	Std. Bore	A	B	C	D	E	F	G	Piston Head Shape	Remarks	Coating	Piston
01.1002.xxx	2-Stroke	40.00	-	51.00	10.00	20.50	10.75	10.75	13.50	Dome	-	-	Cast
01.1003.xxx	2-Stroke	39.00	-	50.50	12.00	17.50	12.00	12.00	15.00	Dome	-	-	Cast
01.1008.xxx	2-Stroke	41.00	-	48.00	10.00	15.00	12.00	12.00	13.00	Dome	-	-	Cast
01.1010.xxx	2-Stroke	39.00	-	53.50	12.00	21.70	8.75	8.75	15.00	Dome	-	-	Cast
01.1012.xxx	2-Stroke	40.00	-	51.00	12.00	19.25	11.00	11.00	15.00	Dome	-	-	Cast
01.1040.xxx	4-Stroke	39.00	-	36.30	13.00	10.50	-	-	15.40	Hollow	2 Valve Pockets	-	Cast
01.1050.xxx	4-Stroke	39.00	-	50.50	13.00	16.00	-	-	15.00	Dome	1 Valve Pocket	-	Cast
01.1052.xxx	4-Stroke	51.00	-	50.00	13.00	13.00	-	-	20.00	Dome	2 Valve Pockets	-	Cast
01.1070.xxx	4-Stroke	47.00	-	49.00	13.00	14.00	-	-	16.00	Dome	2 Valve Pockets	-	Cast
01.1075.xxx	4-Stroke	47.00	-	41.30	13.00	10.50	-	-	16.00	Dome	2 Valve Pockets	-	Cast
01.1090.xxx	4-Stroke	47.00	-	42.30	13.00	13.00	-	-	16.00	Hollow	2 Valve Pockets	-	Cast
01.1095.xxx	4-Stroke	50.00	-	44.20	13.00	12.75	-	-	16.00	Flat	-	-	Cast
01.1110.x	2-Stroke	46.00	45.95	53.00	14.00	17.00	-	11.50	16.50	Dome	Reed cut-out	-	Cast
01.1111.x	2-Stroke	47.00	46.95	53.00	14.00	17.00	-	12.00	16.00	Dome	Reed cut-out	-	Cast
01.1113.x	2-Stroke	47.50	47.45	53.00	14.00	17.00	-	12.00	16.00	Dome	Reed cut-out	Mos2 Skirt Coating	Cast
01.1160.xxx	2-Stroke	48.00	-	51.00	12.00	19.25	14.00	14.00	14.50	Dome	-	-	Cast
01.1163.xxx	2-Stroke	48.00	-	55.50	12.00	19.00	13.50	13.50	15.50	Dome	-	-	Cast
01.1175.xxx	4-Stroke	56.50	-	53.00	15.00	15.50	-	-	19.50	Flat	2 Valve Pockets	-	Cast
01.1176.xxx	4-Stroke	56.50	-	56.50	15.00	15.30	-	-	20.00	Dome	2 Valve Pockets	-	Cast
01.1200.x	2-Stroke	56.00	55.96	67.25	16.00	22.50	12.50	12.50	19.50	Dome	2 Intake Holes	-	Cast
01.1204.xxx	2-Stroke	54.00	-	60.50	14.00	21.00	12.50	-	19.50	Dome	Reed cut-out	-	Cast
01.1205.xxx	2-Stroke	54.00	-	60.50	14.00	21.00	13.00	-	19.00	Dome	-	-	Cast
01.1208.x	2-Stroke	54.00	53.93	60.50	15.00	20.50	11.50	-	17.50	Dome	-	-	Cast
01.1218.x	2-Stroke	54.00	53.94	58.00	15.00	20.50	11.50	-	17.50	Flat	Intake Hole	Mos2 Skirt Coating	Cast
01.1222.x	2-Stroke	54.00	53.94	60.50	15.00	20.50	11.00	-	18.00	Dome	Intake Hole	-	Forged
01.1225.x	2-Stroke	54.00	53.94	62.00	15.00	20.50	0.00	-	18.00	Dome	-	Mos2 Skirt Coating	Cast
01.1227.x	4-Stroke	66.00	65.97	32.40	14.00	13.50	-	-	15.50	Dome	4 Valve Pockets	-	Forged
01.1228.x	4-Stroke	66.00	65.97	33.20	14.00	13.50	-	-	15.50	Dome	4 Valve Pockets	-	Forged
01.1232.x	4-Stroke	66.00	65.97	27.60	14.00	13.50	-	-	15.50	Dome	4 Valve Pockets	-	Forged
01.1265.xxx	4-Stroke	63.00	-	50.75	15.00	17.20	-	-	22.50	Hollow	2 Valve Pockets	-	Cast
01.1272.xxx	4-Stroke	65.00	-	51.60	15.00	17.00	-	-	21.00	Flat	2 Valve Pockets	-	Cast
01.1280.xxx	4-Stroke	53.00	-	43.50	14.00	12.70	-	-	17.50	Flat	1 Valve Pocket	-	Cast
01.1281.xxx	4-Stroke	65.50	-	50.60	15.00	17.50	-	-	22.00	Flat with raised top	2 Valve Pockets	-	Forged
01.1300.xxx	2-Stroke	66.00	-	78.50	18.00	24.00	14.00	14.00	23.50	Dome	Intake Hole	-	Cast
01.1309.xxx	2-Stroke	66.00	-	78.50	18.00	29.00	13.75	13.75	24.00	Dome	Reed cut-out	-	Cast
01.1315.x	2-Stroke	66.40	66.34	79.00	18.00	29.00	14.00	14.00	23.50	Dome	Reed cut-out	Mos2 Skirt Coating	Cast
01.1320.x	2-Stroke	66.40	66.34	75.50	18.00	29.00	14.00	14.00	23.00	Flat	Reed cut-out	Mos2 Skirt Coating	Cast
01.1323.x	2-Stroke	66.40	66.34	75.00	18.00	29.00	13.00	13.00	23.50	Flat	-	Mos2 Skirt Coating	Cast
01.1325.x	2-Stroke	66.40	66.34	79.00	18.00	29.00	13.00	-	23.00	Dome	-	Mos2 Skirt Coating	Cast
01.1338.x	4-Stroke	78.00	77.97	30.00	16.00	11.00	-	-	16.80	Dome	4 Valve Pockets	Mos2 Skirt Coating	Forged
01.1339.x	4-Stroke	78.00	77.97	32.50	16.00	11.00	-	-	16.80	Dome	4 Valve Pockets	Mos2 Skirt Coating	Forged
01.1341.x	4-Stroke	76.80	76.77	33.20	16.00	11.00	-	-	20.00	Dome	4 Valve Pockets	-	Forged
01.1342.x	4-Stroke	76.80	76.77	33.40	16.00	11.00	-	-	16.80	Flat with raised top	4 Valve Pockets	-	Forged
01.1343.x	4-Stroke	76.80	76.77	34.60	16.00	11.00	-	-	16.80	Flat with raised top	4 Valve Pockets	-	Forged
01.1346.x	4-Stroke	76.80	76.77	34.50	16.00	11.00	-	-	16.80	Flat with raised top	4 Valve Pockets	-	Forged
01.1348.x	4-Stroke	79.00	78.97	-	-	-	-	-	-	Dome	4 Valve Pockets	-	Forged
01.1350.x	4-Stroke	79.00	78.97	34.60	16.00	10.50	-	-	17.50	Flat with raised top	4 Valve Pockets	-	Forged
01.1358.xxx	4-Stroke	73.00	-	49.90	17.00	16.50	-	-	22.00	Flat	4 Valve Pockets	-	Cast



















### 4-Stroke Piston Drawing Sheet

Return to: Race Winning Brands Europe B.V. • Fax: (+31) (0)252 689 252 • info@rwbteam.eu

Brand: ..... Model: ..... Year: .....  
Measured dimensions: A: ..... B: ..... C: ..... D: ..... E: ..... F: .....  
Remarks: .....

#### Optional additional information

Piston head details : .....  
(i.e. flat, dome, inverted dome, etc.)  
Piston ring details : .....  
(i.e. thickness, shape, etc.)  
Lubrication holes : .....  
Other : .....

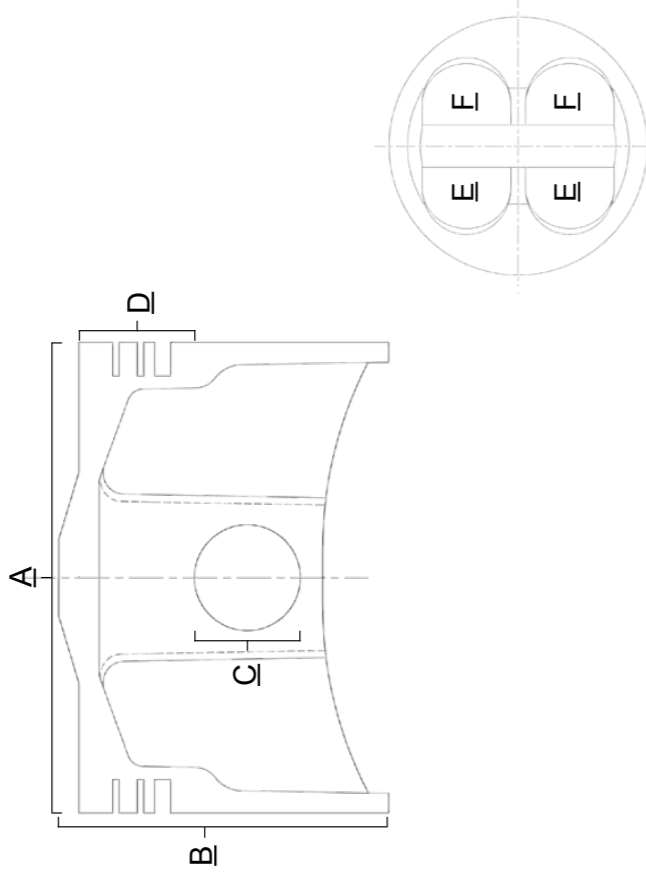

#### Sender Information

Company Name: .....  
Requested action:  
 Return by fax: .....  
 Return by e-mail: .....  
Suggest alternative if preferred item is not available:  Yes  No

To be completed by ProX representative:

Suggested Piston Part No.: ..... Description: .....

Dimensions: A: ..... B: ..... C: ..... D: ..... E: ..... F: ..... G: .....  
Remarks: .....



### Connecting Rod Drawing Sheet

Return to: Race Winning Brands Europe B.V. • Fax: (+31) (0)252 689 252 • info@rwbteam.eu

Brand: ..... Model: ..... Year: .....  
Measured dimensions: A: ..... B: ..... C: ..... D: ..... E: ..... F: ..... G: ..... H: ..... I: .....  
Remarks: .....

#### Optional additional information

Washer size details : ..... X inner X outer X thickness  
Bearing Details : .....  
(i.e. 'M' or 'F' Cage, number of needles, etc.)  
Other : .....

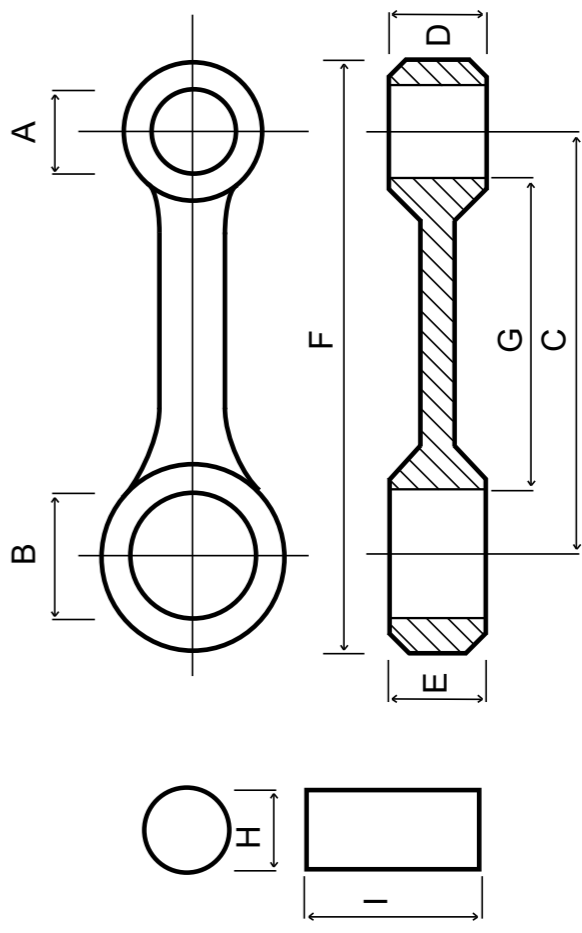

#### Sender Information

Company Name: .....  
Requested action:  
 Return by fax: .....  
 Return by e-mail: .....  
Suggest alternative if preferred item is not available:  Yes  No

To be completed by RWB representative:

Suggested Connecting Rod Part No.: ..... Description: .....

Dimensions: A: ..... B: ..... C: ..... D: ..... E: ..... F: ..... G: ..... H: ..... I: .....  
Remarks: .....